



## A Comprehensive Review of Traditional, Modern and Advanced Presplit Drilling and Blasting in the Mining and Construction Industries

Eric T. Brantson<sup>a</sup>, Titus F. Appiah<sup>a</sup>, Ishaw Alhassan<sup>b</sup>, Alvin K. Kobi<sup>a</sup>, Great M. Dzomeku<sup>c</sup>, Esther O. Boateng<sup>d</sup>, Botwe Takyi<sup>d</sup>, Sibil Samuel<sup>a</sup> and Emmanuel K. Duodu<sup>a</sup>

<sup>a</sup>Department of Petroleum and Natural Gas Engineering, GNPC School of Petroleum Studies, University of Mines and Technology, Tarkwa, Ghana

<sup>b</sup>Department of Mining Engineering, Faculty of Mining and Minerals Technology, University of Mines and Technology, Tarkwa, Ghana

<sup>c</sup>Department of Surface Mining, Golden Star Resources Ltd, Wassa Akyempim, Ghana

<sup>d</sup>Department of Petroleum Geosciences and Engineering, GNPC School of Petroleum Studies, University of Mines and Technology, Tarkwa, Ghana

\*Corresponding author e-mail: [etbrantson@umat.edu.gh](mailto:etbrantson@umat.edu.gh)

### Abstract

#### Article Info

Received 30 Apr. 2023  
Revised 1 Nov. 2023  
Accepted 26 Jan. 2023

#### Keywords

Drilling; Blasting; Presplit;  
Artificial Intelligence; Mining;  
Construction

Presplit drilling and blasting are frequent excavation methods used in the mining and construction industries, but they can be challenging to implement which can also lead to inconsistent results. This review identifies the key mechanisms behind presplit drilling and blasting, and discusses the significant impact that this technique has on the industry. It also emphasizes the major issues that must be addressed before presplit drilling and blasting can be properly implemented, such as the drilling program. The review then introduces the potential application of Artificial Intelligence (AI) tools in presplitting, and discusses how AI can be used to optimize the future design of presplit blast patterns, predict the performance of presplit blasts, and monitor the progress of presplit blasts in real time. The application of AI tools in presplitting has the potential to improve the safety, efficiency, and cost-effectiveness of blasting operations. The review concludes by discussing the future of drilling and blasting in the mining and construction industries, and emphasizes the role of AI optimization as a future tool in moving this field into the autonomous dimension.

### Introduction

No matter the underlying geologic structure, opening up or reshaping the area of interest has historically been a requirement for any engineering project involving the ground or the earth to be as successful and injury-free as possible. To accomplish this, one method has been discovered to handle this plea from the engineering field. Drilling and blasting are the methods that answered the plea of the engineering field; they have proved to be one of the most common methods used for excavation throughout the world. Rock production and rock splitting still rely heavily on drilling and blasting [1]. This technique begins with drilling holes into rock after careful surveying and creating a plan, as its name would imply. Then explosives are carefully placed inside these holes. After that, the explosives are set off, which causes the rock to break apart and crumble. Drill and blast have disadvantages, even though they are most frequently used in mining, quarrying, and

civil engineering projects because they use explosives [2].

Since explosives were first used in mining and construction, engineers and scientists have developed theories to better understand how they break rock in an effort to increase the effectiveness of blasting [3]. These productivity gains have been made in ways to enhance explosives through chemical formulations and manufacturing processes, develop better blast designs to increase fragmentation and heaving of the muckpile and lessen blast-related environmental factors like ground vibration and overbreak of blasts [3]. This is a problem with underground excavations as well, where poor blasting along the blast's perimeter will leave big rocks hanging on the back and ribs of the excavation, immediately posing a risk to nearby workers and being expensive to remove or bolt [3].

Excessive overbreak of a rock face can lead to a variety of issues. The most important of these are the

safety issues with loose rock and bench stability because of cracking [4]. Uneven pressure on the face from the upcoming blasts is another issue. In addition to overbreak, the rock mass may develop voids that will lessen the explosives' overall effectiveness. These concerns are compounded when blasting a jointed rock mass. It is possible for rock masses with joints that dip towards the excavation face to slide along the joints. If the block is dipping away from the excavation face, it may topple over. Attempts have been made to come up with solutions to this issue, with more time and effort being put into developing blasting techniques that prevent overbreak and promote open-pit wall stability [3].

In order to increase the stability of the final excavation and avoid overbreak, a controlled blasting technique must be used to increase slope stability when instability arises [4]. Six controlled blasting techniques have been developed. Each of these has distinctive characteristics and design elements that must be taken into account for effective integration into any blasting plan. Line drilling, trim blasting, buffer blasting, smooth wall blasting, air decking, and presplitting are the six controlled blasting methods that have been developed. In the mining, construction, and tunnelling industries, there are a number of controlled blasting methods that are rarely used. The most commonly used of these techniques is presplitting [4].

The process of presplitting entails forming a plane of shear in solid rock along the desired line of fracture. The main distinction from other techniques for achieving a smoothly finished excavation is that presplitting is done prior to any production drilling and, in some cases, production blasting [1]. Lightly loaded, closely spaced drill holes fired before the production blast are used in presplitting. The purpose of presplitting is to form a fracture plane across which the radial cracks from the production blast cannot travel. The fracture plane that has formed might be aesthetically pleasing and enable the use of slopes that are steeper while requiring less upkeep. Presplitting should be viewed as a preventative measure to prevent the production blasting from harming the final wall [5].

This review provides a comprehensive analysis of presplit drilling and blasting, including traditional, modern, and advanced techniques, and explores the potential of Artificial Intelligence (AI) optimization as a future tool to improve this technique.

## Mechanism of Presplit Drilling and Blasting

The success of a blasting program depends on proper drilling, as a poor pattern can result in the failure of the entire program. Geology can influence blast parameters, but a poor understanding of blasting concepts can also lead to poor blast design changes. Improper presplitting due to these factors

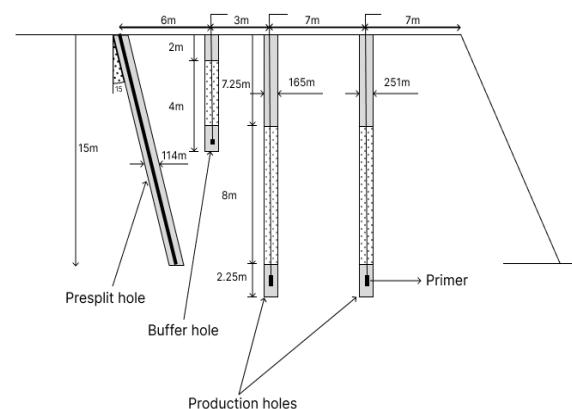
can result in overbreak and unsafe slopes for workers. The root cause of poor presplitting can be due to both geology and the type of drilling used, so a specific drilling pattern must be specified to address the problem before addressing other causes [6]. However, with the advent of precision presplitting, the mechanism behind a presplit is of importance, as changes to dimensions such as the spacing of boreholes and explosive load in a hole are designed to meet the structural geology and rock properties.

### Drilling suitable for presplit blasting

Presplit blasting is a useful method for many impacts in the drilling and blasting spaces. With this method, a curtain of fracture is created by firing the lightly charged holes before the main or primary production blast holes. Along the perimeter of the last excavation, holes are drilled consecutively [7]. Between the holes, the sparingly fired blast creates a zone of fracture, which eventually yields a curtain of fracture. The main primary blast that follows is disrupted by this curtain. The curtain limits the passage of the shock waves generated across it and serves as a pressure release vent for the explosion gases of the charges fired behind the presplit row [8].

### Types of holes for presplit

Three different types of blasting holes—production, buffer, and presplit holes—must be drilled for this kind of blasting. The presplit holes are a single row of boreholes that were drilled with low-density charges along a desired final wall or excavation line [9]. The buffer row, which is the row of holes in front of the presplit line or the back row of the main production holes, needs to be carefully planned in terms of standoff distance from the presplit row as shown in Figure 1.



**Figure 1** Schematic diagram of drilling profile (modified after [10])

The design of the blast considers the depth, diameter, and spacing of the holes, along with the rock properties and explosive load [11]. The goal of presplitting is to create a fracture with a light charge and proper borehole spacing without causing overbreak [11].

### Depth

Short or too deep holes, high floors or capping, and damage to the underlying rock are all undesirable outcomes in drilling for a blast. The accuracy of the drill holes determines the maximum depth for a single pre-split, typically between 15 and 25 metres, and subpar results can occur if the deviation from the desired plane exceeds 150 mm [12]. Pre-split holes can be stemmed to reduce noise, but stemming can create problems if the stemming plug locks into the borehole, causing craters and breaking existing cracks, joints, or bedding planes. Konya and Konya [6] recommend using 30 inches of stemming to simplify the design and make rock type the only consideration for explosive loads.

### Diameter

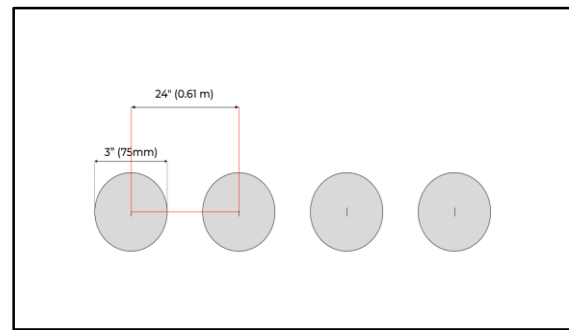
The blast borehole's diameter may differ from the diameter used in the blast design due to various factors such as bit wear in hard rock, soft rock, partially damaged rock, and drill steel slap. Smaller borehole diameters than expected can result in overcharging and explosive energy starvation, while larger diameters increase the risk of underfilling and excessive rock damage [12]. Konya [3] suggests using a 3-inch (75 mm) diameter blast hole to minimise the impact of these variations.

### Spacing of the holes

Presplit spacing is one of the most crucial elements, and it is largely determined by the characteristics of the rock, including the size of the operation and the height of the bench in a particular open pit mine [13]. Adjusting the initial design in response to the results of the blast is necessary to create an efficient presplit design, which can differ by rock type and competence even within a single blast [10]. To get the most out of a particular mine rock type, it is crucial to figure out the right hole spacing and charge [14]. Presplit blasting can suffer from a number of issues, including hole misalignment, insufficient hole spacing, excessive or insufficient hole burden, and an unfavourable decoupling ratio. Presplit blasting results cannot be evaluated until the bench excavation is separated from the presplit line. Singh et al. [14] and Uysal and Cavus [15] also highlighted that the drill pattern is a critical part of blast design and is related to borehole diameter, explosive energy, bench geometry, and rock properties. Drilling straight holes is the most important factor to obtain the desired result in presplit blasting. The holes should be perpendicular to the surface of the rock mass, as highlighted by [14] and [15].

The drilling that does not adhere to the design has negative consequences for the blast result. As a result, a "typical" method of presplitting must use a spacing of 24" (0.61 m) as illustrated in Figure 2. When the spacing is too wide, the hoop stresses would not be enough to create the right kind of fracture, leading to a rough face. In the event that the spacing is too small, the hoop stresses will be so high that multiple radial

cracks will connect between blastholes [3], causing additional fracturing to occur that extends outward from the radial cracks.



**Figure 2** Holes spacing suitable for presplit blasting and drilling

### Explosive load

In the past, precision presplitting was often performed using a spacing of 18" to 24" between holes. Test blasts were used to determine the explosive load, and the back wall was made visible after these blasts to assess the results. The "optimal" explosive load was then determined by an experienced engineer or blaster based on their experience with previous presplitting operations. This old method of precision presplitting had a number of drawbacks, including:

- The use of test blasts was time-consuming and expensive.
- The method was dependent on the experience of the engineer or blaster to determine the optimal explosive load.
- The method could be inaccurate, as the back wall may not have been representative of the entire rock mass.

In recent years, Konya and Konya [16] have derived methods to calculate the optimal explosive load for a precision presplit with a spacing of 24" (0.61 m) center to center based on Young's modulus of the rock [17]. The "typical" method of precision presplitting utilises 24" (0.61 m) of spacing with a 3" (75 mm) diameter blasthole. This simplifies the design by having the rock type to be the only consideration for the explosive load. This was then expanded upon to include equations to determine the explosive load required to cause a fracture to form based on the rock's Young modulus, the Konya presplit factor, and the spacing between boreholes. The calculation of the Konya Presplit Factor is shown in Equation 1:

$$K = 652.56 \times \left(\frac{d^2 \varepsilon}{F}\right)^{\frac{5}{8}} \quad (1)$$

where  $K$  is the Konya Presplit Constant,  $d$  is the diameter of the borehole,  $F$  is the explosive load, and  $\varepsilon$  is the strain.

### Types of presplit blasting

There are various techniques used for presplit blasting, which can be broadly classified into three

categories: traditional presplit blasting, modern presplit blasting, and advanced presplit blasting.

### Traditional presplit blasting

Traditional presplit blasting is the simplest form of presplit blasting, and it involves drilling a row of parallel holes along the intended presplit line. The holes are then loaded with explosives, and the load in the borehole is, at minimum, 0.30 pounds per foot, and the rock is fragmented by the blast [18]. This technique is the most widely used method for presplit blasting due to its simplicity, ease of implementation, and low cost [19].

### Modern presplit blasting

Presplit blasting in the modern era employs more sophisticated methods and technologies than presplit blasting did in the past. Precision presplit blasting is another name for this process; extremely light loads of detonating cord are utilised to prevent all breakage around the borehole while forming the presplit fracture [20]. This design utilised closely spaced boreholes of 24 inches or less to minimise the impacts of rock structure on the presplit [21,22,23]. Modern presplit blasting uses specialized drilling equipment, cutting-edge blasting techniques, and exact timing and sequencing of blasts. This approach achieves better blast control and reduces the blast's negative effects on nearby structures and the environment [24].

### Advanced presplit blasting

Advanced presplit blasting involves the use of the latest technologies and techniques, such as computer-controlled blasting, precision blasting, and the use of special additives to improve the efficiency of the blast [25]. The goal of advanced presplit blasting is to achieve maximum control over the blast and minimise its impact on the surrounding environment and structures.

The choice of presplit blasting technique depends on various factors, including the specific requirements of the project, the type of rock to be excavated, and the available resources and budget. It is crucial to choose the appropriate presplit blasting technique that will meet the specific requirements of the project while ensuring the safety and stability of the surrounding environment and structures.

### Mechanism of presplitting blasting

Rock mechanics is a branch of mechanics that deals with the behaviour of rocks under different loads and conditions. It is an important aspect of presplit drilling and blasting because it helps to determine the strength and stability of the rock mass, which is essential for effective blasting. Understanding the mechanisms of production rock blasting is essential because presplit blasting is also subject to the same forces as rock blasting. The methods by which an explosive exerts pressure and

fractures a rock remain unchanged [3]. The perfect formation of presplitting was once held by the pillars of shockwave theory [26, 27] until an innovative research project was carried out that concentrated on propellant charges that produced no shockwave but had perfect results when fired with detonating explosives as a presplit blast, making presplit mechanisms on a full-scale blast independent of any shockwave generated by detonating explosives.

This led to the development of a precision presplit blasting method. With the increased usage of this design methodology, new empirical research has been conducted to determine explosive loading based on rock properties [17, 28, 29]. The precision presplitting technique takes into account impedance mismatches [30], non-ideal detonation [31], and attenuation of the shockwave in the rock mass [32], resulting in zero shock energy for fracture formation. The high hoop stresses generated between the boreholes are believed to cause presplit formation without any fracture advancement due to gas penetration [33].

### The presplit hoop stress model

The breakage process for a precision presplit breaking under the mechanisms of a hoop stress field has been modified and simplified to include blasting-specific terminology and the equivalent explosive load in grains per foot in Equation 2.

$$\sigma_c = \frac{(0.00684EL_e^2 + 85.5EL_e)}{A^2(S^2 - d_h^2)} \times (A^2 + 1) \quad (2)$$

where  $\sigma_c$  is the magnitude of the hoop stress field in psi,  $EL_e$  is the equivalent explosive load in grains per foot,  $A$  is the distance constant,  $S$  is the spacing in inches, and  $d_h$  is the borehole diameter in inches. In this case, the spacing is 24 inches, and the borehole diameter is three inches. Furthermore, the maximum split distance is assumed to be halfway between the boreholes. This implies that each borehole will require enough explosive load to cause the presplit formation to reach halfway between boreholes. This would set the distance constant ( $A$ ) to a value of 0.5. These assumptions for Equation 2 result in Equation 3, which is a simplified equation for the determination of the hoop stress from the explosive load in a precision presplit.

$$\sigma_c = EL_e(0.00006EL_e + 0.76) \quad (3)$$

$EL_e$  is the equivalent explosive load expressed in grains per foot, and  $\sigma_c$  is the circumferential hoop stress in pounds per square inch. The presplit must form when the equivalent explosive load exerts enough stress to overcome the rock mass's tensile strength. It is significant to note that the presplit fracture will develop at the borehole wall and move away from the borehole toward the second borehole. The fracture must reach halfway between the boreholes or more for the presplit to fully form.

### The presplit shock wave and stress wave model

In comparison to the dynamic compressive strength of the rock mass, which is also the fundamental requirement for the cavity area surrounding the explosives, the shock wave produced by the explosion of explosives in the rock mass puts much more pressure on the rock mass [34]. This area is a broken area that is small but absorbs most of the energy generated by the explosion of explosives, and the attenuation rate of the stress wave is the highest. After the formation of the fracture zone, the unexhausted energy continues to propagate in the rock mass in the form of a stress wave. When the tensile stress of the rock mass is greater than the dynamic tensile strength of the rock, the tensile stress is the main cause of rock failure [35]. After the formation of the radial crack in the rock, the elastic deformation energy stored in the rock mass due to the impact is released. At this time, the direction of the tensile stress is opposite the direction of the radial pressure, and the centripetal tensile stress is generated. The circumferential crack and the radial crack are interconnected and staggered. The rock blasting mechanism is shown in Figure 3.

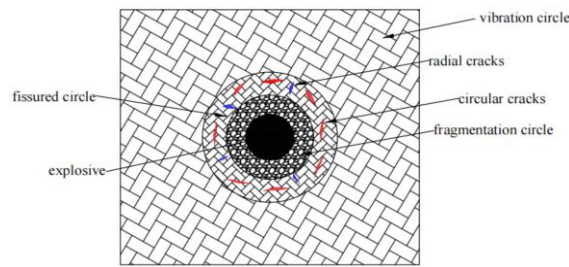


Figure 3 Rock mechanism schematic [35].

When the stress wave propagates in the rock mass, its magnitude decreases with the increase in propagation distance, and the nature and shape of the wave also change accordingly. After the explosion acts on the rock mass, the explosion stress wave propagates outward from the explosion source. The distance relationship between the peak stress and the explosion source can be expressed as Equation 4.

$$\sigma_{rmax} = \frac{p_1}{r^{-\alpha}} \quad (4)$$

In the formula,  $p_1$  is the radial peak stress of the rock element, and  $\alpha$  is the attenuation coefficient of the stress wave. For radial peak stress, the uncoupled charge is used, and  $p_1$  is expressed as Equation 5:

$$p_1 = \frac{1}{8} \rho_a D_a^2 \left(\frac{r_a}{r_b}\right)^6 m \quad (5)$$

In the formula,  $\rho_a$  is the density of explosives,  $D_a$  is the explosive detonation velocity,  $r_a$ , and  $r_b$  are the charge radius and hole radius, and  $m$  is the pressure increase coefficient; generally,  $m = 8-11$ .

$$\sigma_{\theta max} = \omega \sigma_{rmax} \quad (6)$$

The value of  $\omega$  is related to the distance between the stress wave front and the explosion source and the Poisson's ratio  $\mu$  of the rock. When the stress wave front is close to the explosion source,  $\omega=1$ , and when the stress wave front is far from the explosion source, the coefficient approaches

$$\omega = \frac{\mu}{(1-\mu)} \quad (7)$$

According to  $\alpha = 2-\omega$  and simultaneously with Equations 4 and 5, we can obtain:

$$\sigma_{rmax} = \frac{p_a D_a^2 \left(\frac{r_a}{r_b}\right)^6 m}{8 r^{-(2-\omega)}} \quad (8)$$

According to isentropic correlation theory, isentropic exponential initial stress is introduced:

$$p_0 = \frac{1}{2(K+1)} \rho_a D_a^2 \quad (9)$$

Combining Equations (7) and (8), the expressions of radial compressive stress and tangential tensile stress, considering the initial stress of the isentropic index, can be obtained:

$$\sigma_{rmax} = \frac{(K+1)p_0 \left(\frac{r_a}{r_b}\right)^6 m}{4 r^{-(2-\omega)}} \quad (10)$$

$$\sigma_{\theta max} = \omega \frac{(K+1)p_0 \left(\frac{r_a}{r_b}\right)^6 m}{4 r^{-(2-\omega)}} \quad (11)$$

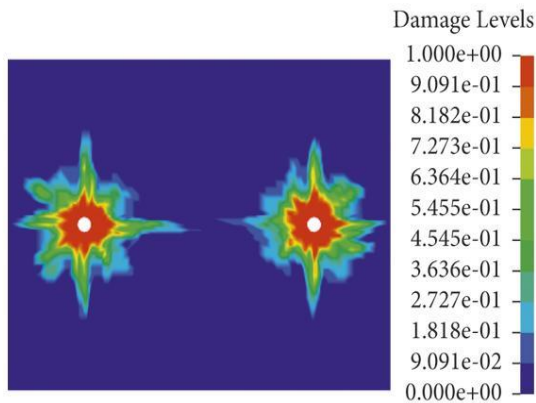
### Concept of Presplit from a Numerical Simulation Point of View

An important aspect of the analysis of blasting mechanics is the numerical simulation of the blasting process. One of the most effective methods, LS-DYNA3D, is used to analyse the nonlinear dynamic questions, such as stress propagation and crack evolution characteristics, in order to study the deep-hole presplit cracking mechanism with an empty hole [36]. Numerical model takes the model test as the prototype, which consists of three components: air, explosives, and concrete. Referring to the literature [37], keywords are used to define concrete and explosives, and the JWL equation of state is used to describe the relevant parameters of the explosives, as shown in the Equation 12:

$$P = A e^{R_1 v} \left(1 - \frac{\omega}{R_1 V}\right) + B e^{R_2 v} \left(1 - \frac{\omega}{R_2 V}\right) + \frac{\omega E_0}{V} \quad (12)$$

where  $V$  is the relative specific volume of the detonation product of dimensionless;  $E_0$  is the initial internal energy of the explosive per unit volume (Pa);  $\rho$  is the explosive density ( $\text{g}/\text{cm}^3$ );  $D$  is the detonation velocity (m/s);  $P$  is the explosion pressure (kPa); and  $A$ ,  $B$ ,  $R_1$ ,  $R_2$ , and  $\omega$  are all parameters related to explosive materials. The final results are illustrated in Figure 4.

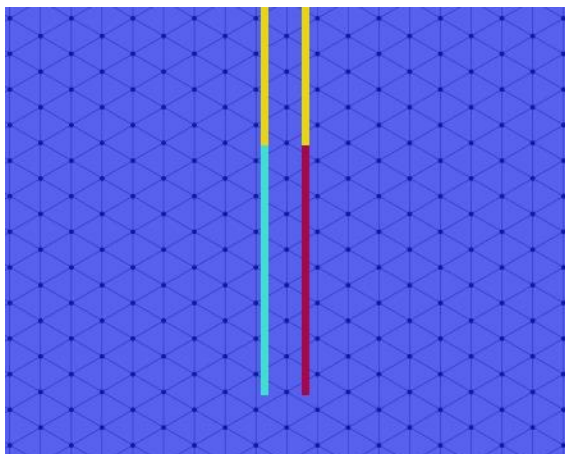




**Figure 4** Near-zone damage nephogram of a blasting model with different delay times [36].

### Modelling and grid specification

Following simulations by Chen et al. [4], this modelling and grid meshing were devised based on Cartesian theory. A 50 mm-diameter explosive cylinder and 0.1 m x 0.1 m rock rectangles were used in the model's centre to refine the grid. "Mapped" homogenised the grids of the explosive and the rock. The explosive material was 3.2 mm in diameter on average. The rock elements ranged in size from 3.3 mm to 8.3 mm, with a 1.17 spacing ratio between adjacent elements. The grid meshing of rock was fine enough to accurately simulate the engineering problem of blasting presplitting, and the grid near the blasting hole is shown in Figure 5. This combination with the comparison between grid size and fracture opening of rock mass on site is shown in Figure 5.



**Figure 5** Schematic for grid division.

### Parameters for blasting

Due to the synergistic effects of various driving forces and the fracture features zone shown in Equation 13, the hole spacing  $L$  could be divided into four components,  $R_c$ ,  $R_p$ ,  $l_{t(max)}$ , and  $l_{k(max)}$ :

$$L = 2(R_c + R_p + l_{k(max)} + l_{t(max)}) \quad (13)$$

The division of rock mass and explosive in the modelling can be meshed with Euler, and the multi-material ALE algorithm is used, which will allow a grid to include rock mass and explosive detonation products for analysing element deformation and explosive detonation product diffusion. This method addresses the issue of calculation interruption and simulation accuracy caused by the serious distortion of Lagrange element meshing during the blasting process. The gravitational pull of the rock mass is not taken into account during the simulation process. Non-reflective boundary constraints are used to reduce the impact of stress reflection and stress concentration on the border [4].

### Impact of Presplit Drilling and Blasting

Presplit drilling is a commonly used technique in the mining and construction industries to improve safety, increase efficiency, and reduce costs during blasting operations. In addition to these benefits, presplit drilling can also have a positive impact on reducing ore dilution and vibration levels in the rock mass.

### Safety of personnel, equipment and cost

The impact of presplit drilling on the safety of personnel and equipment is significant. By creating a buffer zone, the likelihood of flyrock, or rock fragments thrown outside of the blast area, is greatly reduced [38]. This can help to prevent injuries to personnel working in the area, as well as reduce the potential for damage to equipment, buildings, and other structures. Additionally, presplitting helps to reduce the amount of overbreak, or rock that is damaged or broken beyond the intended blast area, which can also improve safety and reduce costs associated with repairing the damage [39].

Presplit drilling can also have a positive impact on cost. By reducing the amount of overbreak and flyrock, less material needs to be excavated and disposed of, which can result in cost savings. Additionally, presplitting can help to optimize fragmentation, which can improve the efficiency of subsequent excavation and hauling operations, further reducing costs (Afum and Temeng, 2015).

Several studies have demonstrated the benefits of presplit drilling. For example, a study conducted by the South African Institute of Mining and Metallurgy found that presplitting can reduce the likelihood of flyrock by up to 90% and reduce overbreak by up to 50%. Another study conducted by the International Society of Explosives Engineers found that presplitting can improve fragmentation and reduce total costs by up to 30% [39].

Presplit drilling is a highly effective technique for improving safety, reducing costs, and optimising blasting operations in the mining and construction industries. Its impact on safety of personnel,

equipment, and cost has been demonstrated through numerous studies and applications in the field [40].

When the actual volume of rock debris is greater than the theoretical volume, especially in underground exploitations, the maintenance and worker safety costs of tunnel installation rise significantly.

### High wall stability

Failure of the mine walls could result in fatalities, traffic snarl-ups, and damage to the equipment used in mining, as well as halt production at the face temporarily or permanently and in the worst-case scenario, force the closure of the mine. Presplit blasting is the most practical and efficient method for resolving this issue in open pit metal mines, though there are other techniques for improving wall stability in open pit mines. This is because resources have hard formations by their very nature.

Several studies have demonstrated the benefits of presplit drilling for high wall stability. For example, a study conducted by the US Bureau of Mines found that presplitting can reduce overbreak and minimise the risk of high wall instability in open-pit mines [41]. Another study conducted by the Society of Mining Engineers found that presplit drilling can help control the direction of blasting and minimise the potential for high wall instability [42].

Precise control over the blast and the use of modern presplit blasting techniques can minimise the impact of the blast on surrounding structures and the environment, thereby reducing the risk of damage and ensuring a safer working environment [19]. Additionally, the use of presplit drilling and blasting can also reduce the risk of rock falls, which is a common cause of accidents in rock excavation [24].

### Reduction in ore dilution and reduced vibration level in rock mass

The use of presplit drilling and blasting also has an impact on the environment. The use of presplit drilling and blasting can have a significant impact on the environment. Traditional presplit blasting techniques can result in excessive noise and vibration levels, which can cause damage to nearby structures and wildlife habitats [25]. Modern presplitting techniques can help to minimize the environmental impact of blasting operations by reducing noise and vibration levels. However, further research is needed to develop and evaluate the effectiveness of modern presplitting techniques in reducing the environmental impact of blasting operations [19].

Ore dilution is a significant concern in mining operations, as it reduces the quality and quantity of the ore that can be extracted from a given area. Presplit drilling can help reduce ore dilution compared to other drilling methods by creating a clean, stable

surface for subsequent drilling and blasting operations. This can minimize the amount of waste rock that is included in the ore. Some researches that support the assertion that presplit drilling can reduce ore dilution: A study by Singh et al. [15] found that presplit blasting reduced ore dilution by up to 50% compared to conventional blasting. Also, a study by Uysal and Cavus [16] found that presplit blasting reduced ore dilution by up to 25% compared to smooth wall blasting. Konya and Konya [3] study found that presplit blasting reduced ore dilution by up to 15% compared to other drilling and blasting methods. These studies suggest that presplit drilling can be an effective way to reduce ore dilution in mining operations.

Presplit drilling can also help reduce vibration levels in the rock mass during blasting operations. Excessive vibration can cause damage to equipment, buildings, and other structures, as well as create safety hazards for personnel. By reducing vibration levels, presplit drilling can improve safety, reduce equipment damage, and minimise the need for costly repairs and maintenance.

Several studies have demonstrated the benefits of presplit drilling for reducing ore dilution and vibration levels in the rock mass. For example, a study conducted found that presplit drilling can help control the direction of blasting and minimise the potential for ore dilution and vibration [44], with the results shown in Figure 6. Another study conducted by the US Bureau of Mines found that presplitting can reduce overbreak and minimise the amount of waste rock included in the ore [41].



Figure 6 BMM explorer calculation of ore loss, dilution, and misclassification [44].

### Artificial Intelligence application in drilling and blasting

Temeng et al. [45] develop a model with brain inspired emotional neural network (BI-ENN) to predict air overpressure (AOp) as an end product of blasting. Despite obtaining good predicted results with this Artificial intelligence model (Figure 7), it was not tested on presplit drilling and blasting activities. Also, Al-Bakri and Sazid [46] reviewed work highlighted the

prediction models for blast-induced fragmentation with the introduction of artificial intelligence model to practically achieve optimized blasting operation with reduced undesirable effects. Besides the importance of artificial intelligence prediction models to mining operations, the literature lacks research articles on presplit drilling and blasting activities as shown in Figure 8. Ground vibration (Peak particle velocity (PPV)) as a result of blasting in a surface lead-zinc mine was predicted using machine learning ensemble techniques with good prediction results as shown in Figures 9 and 10 [47]. Again, the focus of their work was on blasting effects but not in relation to presplit blasting technique. Lastly, it can be observed from the above literature reviewed that more attention needs to be geared towards this technique using AI tools [48-50].

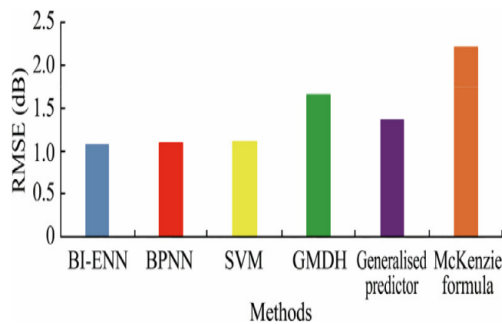


Figure 7 RMSE performance of the various models for predicting AOp [45].



Figure 8 The trend of annual articles published recently under ANN applications for blast-induced impacts prediction [46].

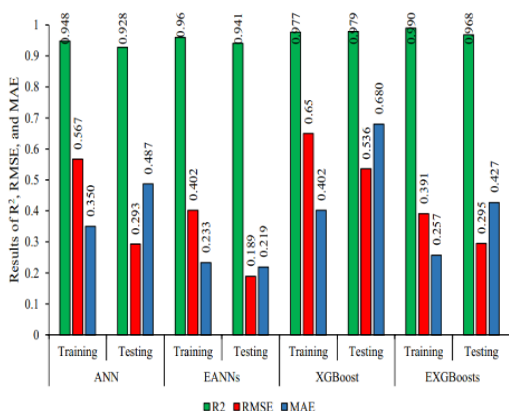


Figure 9 The value of R<sup>2</sup>, RMSE, and MAE for selecting the best model in the predicting PPV values [47].

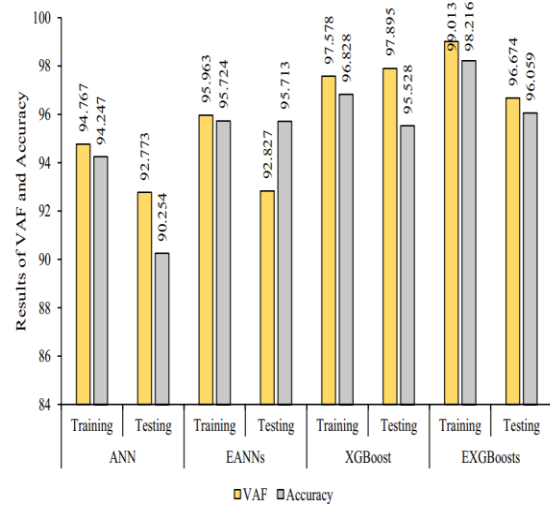


Figure 10 The value of VAF and accuracy for selecting the best model in the predicting PPV values [47].

### Discussion

Presplit drilling and blasting are critical processes used in rock excavation and mining operations. The technique involves drilling and blasting a line of holes prior to main blasting, resulting in improved rock fragmentation, reduced blast damage, and increased excavation efficiency. A comprehensive review of presplit drilling and blasting, covering its history, types, mechanisms, impact, and major issues, has been provided.

The mechanisms that support presplit drilling and blasting have been thoroughly explored in numerous literatures. In this review, it ranges from the conventional approaches to the numerical modelling approaches and their significant importance in the overall economy of entire mining and construction operations. However, the examined papers show a scarcity of articles devoted to presplitting rock fragmentation prediction using artificial intelligence, though for the time being it appears the mining industry is very satisfied. More room is required for artificial intelligence to weave the mechanism of presplit drilling and blasting in order for the rock excavation industry to get the most out of the technique.

This will surprise the industry with the outcomes involving artificial intelligence and even the choice of the explosive type, explosive load, diameter of holes drilled, geometry that must be assumed when the holes are drilled, and even the delay of the firing sequence of the explosive as suggested by some literature by Eades and Perry [4]. This can be referred to as the presplit drilling and blasting technique's future because the more complex iteration of this method is having trouble coping with some complexities. Furthermore, some literature and



industry attribute this to the geological structure of the implementation location even when the approved, tried, and tested procedures outlined to achieve the desired results are adhered to correctly.

For any successful presplit blasting, the requirement for drilling accuracy is very paramount. Hole deviation as a result of presplit drilling can have significant effect on the vertical fracture plane as shown in Figure 11. However, if the presplit is not successful as a result of inaccurate drilling, it creates an additional cost for redrills and blasting as shown in Figure 12. A successful presplit drilling and blasting as shown in Figure 13 has the ability to achieve catch berms for safety of personnel and equipment, highwall stability, minimises crest damages and reduces ground vibration [43]. Some practical methods to ensure a successful presplit drilling and blasting (Figure 13) are presplit design audits, angle adjustment in unstable formations, use of manual inclinometers, data capturing and tracking with driller details, and post blast presplit assessments after battering.



Figure 11 Common presplit drilling errors.



Figure 12 Borehole deviation and redrills.



Figure 13 Improved presplit drilling and blasting.

Another advancement in terms of presplit blasting is the timing sequences of the drilled presplit holes. Usually, the presplit holes are usually detonated either before the production shot or on the first delay of the production shot. Figure 14 shows the fracture plane with different timing patterns [51]. It can be observed that the presplit holes fired simultaneously performed optimally well than with firing individual and short delays in improving high wall stability. Now, more future research (investigate AI optimal delay timing sequences for presplit blasting operations) is needed to address problems in terms of its applicability and performance related to using AI optimal delay timings between presplit holes due to the advent of electronic detonators. Additionally, timing sequences in presplit blasting will provide mining and construction operations with an alternative tool that will produce more stable excavated boundaries at a lower cost.



Figure 14 Effects of using delays on presplit holes [51].

## Conclusions

In conclusion, the extensive review of presplit drilling and blasting techniques reveals that:

- Presplit drilling and blasting are widely applicable in various rock excavation industries, offering advantages like enhanced high wall stability, reduced ore dilution, lower vibrations, and improved safety.
- While these presplit techniques have evolved, a significant opportunity exists to enhance them through the integration of AI. Also, this review emphasizes the need for further

research in AI-based presplitting systems to fully harness the potential of AI in this field.

- AI can predict blast performance, optimize blast patterns, enable real-time monitoring, and prevent failures, with potential applications such as predicting and minimizing overbreak in presplit blasts.
- The mining and construction industries move towards automation highlights the importance of advanced algorithms and machine learning in enabling remote and autonomous management while reducing the need for human intervention in operational areas.

## Funding Sources

“This research was funded by ‘Ghana Chamber of Mines’”

## Conflicts of Interest

The authors declare that they have no conflict of interests.

## Acknowledgements

We appreciate Ghana Chamber of Mines for their tremendous financial support in carrying out this research work. Also, we thank University of Mines and Technology, Tarkwa, Ghana, GNPC School of Petroleum Studies, Petroleum and Natural Gas Engineering Department for their immense support.

## References

- [1] Sharafisafa, M., & Mortazavi, A. (2011, June). A numerical analysis of the presplitting controlled blasting method. In ARMA US Rock Mechanics/Geomechanics Symposium (pp. ARMA-11). ARMA.
- [2] Pomasoncco-Najarro, A., Trujillo-Valerio, C., Arauzo-Gallardo, L., Raymundo, C., Quispe, G., & Dominguez, F. (2022). Pre-split blasting design to reduce costs and improve safety in underground mining. *Energy Reports*, 8, 1208–1225.
- [3] Konya, A. J. (2019). The mechanics of precision presplitting. *Missouri University of Science and Technology*.
- [4] Eades, R. Q., & Perry, K. (2019). Understanding the connection between blasting and highwall stability. *International Journal of Mining Science and Technology*, 29(1), 99–103.
- [5] Rossmannith, H. P., & Uenishi, K. (2008, October). The Cuña Problem—Reconsidered. In *Proceedings of the 12th International Conference of International Association for Computer Methods and Advances in Geomechanics (IACMAG)* (pp. 1-6). Goa: October
- [6] Konya, A., & Konya, C. (2017b). Precision presplitting - Explosive variations with spacing. In *Proceedings of the 43rd International Conference on Explosive and Blasting Technique*.
- [7] Brian, F. (2011). *Blasthole Drilling in Open Pit Mining*. Garland Texas USA: Atlas Copco Drilling Solutions LLC, 274.
- [8] AC06411500, A. (Ed.). (2006). *Surface drilling in open pit mining*. Atlas Copco Rock Drills AB.
- [9] Rajmeny, P. K., Joshi, A., & Bhandari, J. (2006). *Blast designing: Theory & practical*. Himanshu Publications.
- [10] Oraee, K., Mozafari, A., Goodarzi, A., & Oraee-Mirzamani, N. (2013). Final wall stability in metal open pit mines using presplit blasting. In *23rd World Mining Congress-Mapping the Future: Advances in Mining Engineering*. X-CD Technologies Inc.
- [11] Mazzella, B. M. (2023). Blast protection and control for drilling and mining. T.M.I. Mazzella Blasting Mats. Retrieved January 17, 2023, from <https://www.tmi2001.com/blog/blasting-mats-drilling-mining/>
- [12] Lindi, O. (2020). The effectiveness of pre-splitting as a method of wall control and minimize over-break in North Mara Gold Mine. *MUST Journal of Research and Development*, 1(1), 15.
- [13] Sjöberg, J. (1996). Large scale slope stability in open pit mining. Division of Rock Mechanics, Luleå University of Technology.
- [14] Singh, P. K., Roy, M. P., & Paswan, R. K. (2014). Controlled blasting for long term stability of pit-walls. *International Journal of Rock Mechanics and Mining Sciences*, 70, 388–399.
- [15] Uysal, Ö., & Cavus, M. (2013). Effect of a pre-split plane on the frequencies of blast induced ground vibrations. *Acta Montanistica Slovaca*, 18(2).
- [16] Konya, A., & Konya, C. J. (2016). Precision presplitting optimization. In *Proceedings of the Forty-Second Annual Conference on Explosives and Blasting Technique* (pp. 65–74).
- [17] Rodgers, A., Tkalcic, H., McCallen, D., Larsen, S., & Snelson, C. (2006). Site response in Las Vegas Valley, Nevada from NTS explosions and earthquake data. *pure and applied geophysics*, 163, 55-80.
- [18] Calvin, K. J., & Walter, E. J. (1990). *Surface Blast Design*.
- [19] Chen, Z. W., Liu, Q. Q., Zhang, X., & Wu, Q. M. (2020). Dynamic monitoring and numerical simulation of a bench blast in a presplit excavation. *Journal of Rock Mechanics and Geotechnical Engineering*, 12(5), 863–871.
- [20] Konya, C. (1982). Seminar on blasting to the Ohio Laborers Union. Mont Vernon, Ohio.
- [21] Worsley, P. (1984). The effect of discontinuity orientation on the success of pre-split blasting. In *10th Annual Society of Explosive Engineers Conference on Explosives*.
- [22] Worsley, P., & Qu, S. (1987). Effect of joint separation and filling on pre-split blasting. In *13th Society of Explosive Engineers Conference on Explosives and Blasting Technique*.
- [23] Tariq, S., & Worsley, P. (1996). An investigation into the effects of some aspects of jointing and single decoupled blast holes on pre-splitting and boulder blasting. In *Rock Fragmentation by Blasting - Fragblast 5* (p. 438).
- [24] Choy, J. L., Lee, W. T., Tan, K. W., & Loh, W. Y. (2019). Modelling of rock fragmentation in presplit blasting using coupled discrete element method and fracture mechanics. *Engineering Geology*, 265, 94–104.
- [25] Javed, M. J., Sheikh, M. A., & Khan, M. R. (2019). Investigation of rock fragmentation using presplit blasting in marble quarries. *Journal of Rock Mechanics and Geotechnical Engineering*, 11(5), 699–705.
- [26] Sudweeks, W. B., & Collins, T. K. (1979). Alternative oxidizers for strip coal mine blasting agents.[Including study of possible substitutes; 53 references] (No.

- DOE/ET/13347-1). IRECO Chemicals, Salt Lake City, UT (USA).
- [27] Bauer, A. (1982, May). Wall control blasting in open pits. In *Proceedings of the 14th Canadian Rock Mechanics Symposium*, Vancouver, British Columbia, Canada (pp. 3-10).
- [28] Brantson, E. T., Appiah, T. F., Alhassan, I., Dzomeku, G. M., Boateng, E. O., Takyi, B., ... & Kobi, A. K. (2024). A comprehensive review of traditional, modern and advanced presplit drilling and blasting in the mining and construction industries. *Journal of Petroleum and Mining Engineering*, 25(2), 87-97.
- [29] Konya, A., & Konya, C. (2017). Precision Presplitting-Explosive Variations with Spacing. In *Proceedings of the 43rd International Conference on Explosive and Blasting Technique*.
- [30] Cooper, P. W., & Kurowski, S. R. (1997). *Introduction to the Technology of Explosives*. John Wiley & Sons.
- [31] Cook, M. A. (1974). *The science of industrial explosives*. Ireco Chemicals.
- [32] Spathis, A. T., & Wheatley, M. G. (2016). Dynamic pressure measured in a water-filled hole adjacent to a short explosive charge detonated in rock. *Blasting and Fragmentation Journal*, 10(1), 33-42.
- [33] Lv, Y., Yuan, C., Fu, Y., Zhu, X., Gan, Q., Li, H., & Chen, Q. (2022). Empty-hole effect on fracture propagation under blasting load. *Arabian Journal of Geosciences*, 15(8), 765.
- [34] Han, Y., & Liu, H. (2015). Finite element simulation of medium-range blast loading using LS-DYNA. *Shock and Vibration*, 2015(1), 631493.
- [35] Wang, B., Li, H., Shao, Z., Chen, S., & Li, X. (2021). Investigating the mechanism of rock fracturing induced by high-pressure gas blasting with a hybrid continuum-discontinuum method. *Computers and Geotechnics*, 140, 104445.
- [36] Ma, J., Li, X., Wang, J., Li, Q., Zuo, T., Wu, X., & Hou, M. (2021). Numerical simulation on selection of optimal delay time for precise delay blasting. *Shock and Vibration*, 2021(1), 4593221.
- [37] Yao, S., Ma, Y., Zhao, N., Wang, Z., Zhang, D., & Lu, F. (2022). Equivalent scaling method on the dynamic response of box-shaped structures under internal blast. *International Journal of Impact Engineering*, 160, 104074
- [38] Langefors, U., & Kihlström, B. (1963). *The modern technique of rock blasting*. John Wiley & Sons.
- [39] Murlidhar, B. R. (2020). *Rock mass classification for predicting environmental impact of blasting on tropically weathered rock*(Doctoral dissertation, Universiti Teknologi Malaysia
- [40] Bobet, A., & Fairhurst, C. (2005). Measurements of overbreak damage and block movement in bench blasting. *International Journal of Rock Mechanics and Mining Sciences*, 42(2), 233-243.
- [41] Jennings, J. E., Siskind, D. E., & Kopp, R. C. (1988). *Reducing overbreak in bench blasting by presplitting*. US Bureau of Mines Information Circular 9137.
- [42] Brady, B. H., & Brown, E. T. (2006). *Rock mechanics: for underground mining*. Springer science & business media.
- [43] Hettinger, M. R. (2015). *The effects of short delay times on rock fragmentation in bench blasts*. Missouri University of Science and Technology.
- [44] Eshun, P. A., & Dzibordi, K. A. (2016). Control of ore loss and dilution at AngloGold Ashanti, Iduapriem mine using blast movement monitoring system. *Ghana Mining Journal*, 16(1), 49-59.
- [45] Temeng, V. A., Ziggah, Y. Y., & Arthur, C. K. (2020). A novel artificial intelligent model for predicting air overpressure using brain inspired emotional neural network. *International Journal of Mining Science and Technology*, 30(5), 683-689.
- [46] Al-Bakri, A. Y., & Sazid, M. (2021). Application of artificial neural network (ANN) for prediction and optimization of blast-induced impacts. *Mining*, 1(3), 315-334.
- [47] Hosseini, S., Pourmirzaee, R., Armaghani, D. J., & Sabri Sabri, M. M. (2023). Prediction of ground vibration due to mine blasting in a surface lead-zinc mine using machine learning ensemble techniques. *Scientific Reports*, 13(1), 6591.
- [48] Brantson, E. T., Ju, B., Appau, P. O., Akwensi, P. H., Peprah, G. A., Liu, N., ... & Borsah, A. A. (2020). Development of hybrid low salinity water polymer flooding numerical reservoir simulator and smart proxy model for chemical enhanced oil recovery (CEOR). *Journal of Petroleum Science and Engineering*, 187, 106751.
- [49] Brantson, E. T., Ju, B., Omisore, B. O., Wu, D., Selase, A. E., & Liu, N. (2018). Development of machine learning predictive models for history matching tight gas carbonate reservoir production profiles. *Journal of Geophysics and Engineering*, 15(5), 2235-2251.
- [50] Brantson, E. T., Ju, B., Ziggah, Y. Y., Akwensi, P. H., Sun, Y., Wu, D., & Addo, B. J. (2019). Forecasting of horizontal gas well production decline in unconventional reservoirs using productivity, soft computing and swarm intelligence models. *Natural Resources Research*, 28, 717-756.
- [51] Plewman, R. P., & Starfield, A. M. (1965). The effects of finite velocities of detonation and propagation on the strain pulses induced in rock by linear charges. *JS Afr Inst Min Metall*, 66, 77-96.