

(Review)

Factors Influencing Swelling Potential of Expansive Soils

Ibrahim, F. El-Demary¹

¹Lecturer at Egyptian Russian University, Faculty of Engineering, Construction Engineering Department.

*Corresponding author(s): Ibrahim, F. El-Demary, E-mail: ibrahim-eldemary@eru.edu.eg

Received 10th January 2024, Revised 7th July 2024, Accepted 30th October 2024.

DOI:10.21608/erurj.2024.261891.1109

ABSTRACT

Some clays have the ability to increase in volume when absorbing water, inducing swelling pressure and swelling strain. This type of clay is an unsaturated soil named expansive soil. Expansive soils are located in new desert cities in Egypt. The development of such arid areas for urban expansion driven by the increase in population and economic progress faces a challenge due to significant damage to buildings and infrastructures such as highways pipelines found over such problematic soil that causes economic losses. Numerous factors contribute to the problem, such as soil type, soil properties, foundation type, and nature of the project. The physical and chemical properties of such clays affect quantitatively its swelling potential. The most important properties are initial moisture content, initial dry density, clay fabric, compaction method, compaction energy, clay mineralogy, stress path, surcharge pressure, degree of saturation and sample thickness. This paper aims to deeply understand the mechanism of swelling and factors influencing its potential to help the geotechnical engineer select a suitable treatment measurement to alter its detrimental effects by modifying the influencing factors, consequently making aired areas more feasible for construction purposes.

Keywords: Expansive Soil, Swelling Pressure, Swelling Strain.

1.Introduction

Volumetric changes occurring to expansive soils cause severe damage to buildings and infrastructures due to the induced swelling pressure and swelling strain, resulting in economic

losses and representing a challenge. The extent of damage depends on the severity of these volume changes, which is a function of numerous properties.

Initial moisture content has a remarkable effect on the swelling pressure and strain. An experimental study conducted by Rao et al. (2004) showed that the swelling pressure and strain decreased as the initial moisture content increased due to the decrease in the soil's ability to absorb water as its saturation approached 100%.

The initial dry density of soil greatly influences its swelling potential. An exponential increase in the swelling pressure was observed as the dry density increased (Fredlund and Rahardjo (1993)).

Cui et al. (2012) conducted a study on sand–bentonite mixtures; this study showed a linear relationship between the swell strain and the initial dry density, while an exponential increase was detected between the maximum vertical swelling pressure and the increase in initial dry density.

Clay fabric is considered a factor that impacts the soil's swelling potential, where the clay particles' orientation remarkably affects the expansive soils' swelling potential. Baser (2009) reported that clays with a flocculated structure are more expansive than clays with a dispersed structure.

The compaction method had proved its perceived effect on the expansiveness of the soil. This is attributed to its influence on the orientation of clay particles, which changes the clay fabric. In addition, the variation in the achieved soil density results from the distinct energy efficiency between each compaction method.

Attom et al. (2001) stated that static compaction causes a decrease of 30 % in the swelling potential for different clay soils. The kneading and impact compaction can change the soil fabric from flocculated or random at low moisture content to parallel (Seed and Chan (1959)). Static compaction produces higher density because it is more energy-efficient than dynamic compaction (Boonsinsuk et al. (1991)).

The compaction energy was witnessed as directly affecting the swelling potential of expansive soil. Linear relationship was observed between the swelling pressure and the compaction energy (Sridharan and Gurtug (2004)).

The clay particle mineralogy impacts the degree of clay expansiveness. Chen (1988) reported that illite, kaolinite, and montmorillonites induce different swell potentials and are the main vital clay minerals.

The stress path was observed to affect the swelling pressure and swelling strain; the swell overburden test method induced the lowest pressure and strain, while the free swell test method induced the highest values. Intermediate values were obtained using the constant volume test method (Al – Mhaidib (1999)).

The increase in surcharge pressure has a pronounced reducing effect on the swelling pressure and volume increase for expansive soils (Estabragha et al. (2013)).

The increase of saturation reduces the swell potential of soils. An experimental study by Borgesson (1985) showed that the swelling pressure is directly proportional to the degree of saturation.

The sample thickness does not affect the expansiveness of the soil. An experimental study executed by Chen (1988) proved that the swelling pressure and the percentage of volume increase were constant for all the samples regardless of the thickness variety.

2. Mechanism of swelling

The clay particle is composed of clay mineral crystals, while each crystal is formed of sheets of molecules created from the bonds between atoms. The surface of the clay sheet is negatively charged.

Water molecules are considered dipoles; meanwhile, the positive and negative charge centres in the molecule do not coincide; this leads to the attraction of the positive charges of the water molecules to the negatively charged clay sheet surface.

The continuous flow of water to neutralize the negative charge of the clay sheet increases the distance between the sheets, causing the soil to swell. The thickness of the attracted water molecules depends on the intensity of the attractive forces; these attractive forces fade away from the sheet surface where the sheet can no longer attract any cations of the water molecules.

The layer of the attracted water molecules is known as the diffused double layer. The diffused double layer's thickness is affected by the nature of exchangeable cations in the water, electrolyte concentration in the water, base exchange capacity and the temperature.

Chen (1988) reported that the type and amount of clay minerals, their exchangeable ions, and the internal structure and electrolyte percent in the aqueous phase determine the degree of clay expansiveness. He also noted that montmorillonites mineral carries a large negative charge compared to illite and kaolinite, enabling it to absorb cations ten times more than kaolinites, consequently having greater swelling potential.

3. Stages of swelling

Dafalla and Al – Shamrani (2011) identified three main swelling zones: the primary swelling stage, secondary swelling stage and the tertiary swelling stage.

The primary swelling stage is the time needed for water to fill all open spaces and reach stress equalization. They stated that the period of this stage is dependent on stress conditions, soil texture and clay mineralogy. The swelling amount during this period cannot be expected, and the swelling rate changes from negative to positive.

According to ASTM (D 4546) (2003), the primary swell is defined as an arbitrary short-term swell usually characterized as being completed at the intersection of the tangent of reverse curvature to the curve of a dimensional change-logarithm of time plot with the tangent to the straight line portion representing long-term or secondary swell as presented in Figure (1).

Sivapullaiah et al. (1996), stated that the primary swell starts after the voids of the nonswelling soil particles are filled with the swelling clay, and it follows a hyperbolic relationship with time. They stated that the primary swell time is determined by the intersection of the curve's primary and secondary segments.

Domitrović and Kovačević (2013), performed swelling tests on bentonite using a standard oedometer cell having a diameter of 74 mm. The bentonite was placed without any loading with an initial water content of 12 %. Three vertical stresses were applied, namely 50, 100 and 200 kPa. Results indicated that the primary swelling stage period was the same for all vertical stresses, which took 31 days to end.

Dafalla and Al – Shamrani (2011) stated that the secondary swelling stage has a stable or slightly changing slope for a prolonged period. According to ASTM (D 4546) (2003), the secondary swell is defined as an arbitrary long-term swell usually characterized as the linear portion of a dimensional change-logarithm of time plot following the completion of short-term or primary swell as shown in Figure (1). Sivapullaiah et al. (1996) noted that the secondary swell is the swelling occurring for a long time after the primary swell's completion.

The tertiary swelling stage starts after the secondary swelling stage by a sudden decrease of swelling rate and extends for a long period with the swelling rate approaching zero.

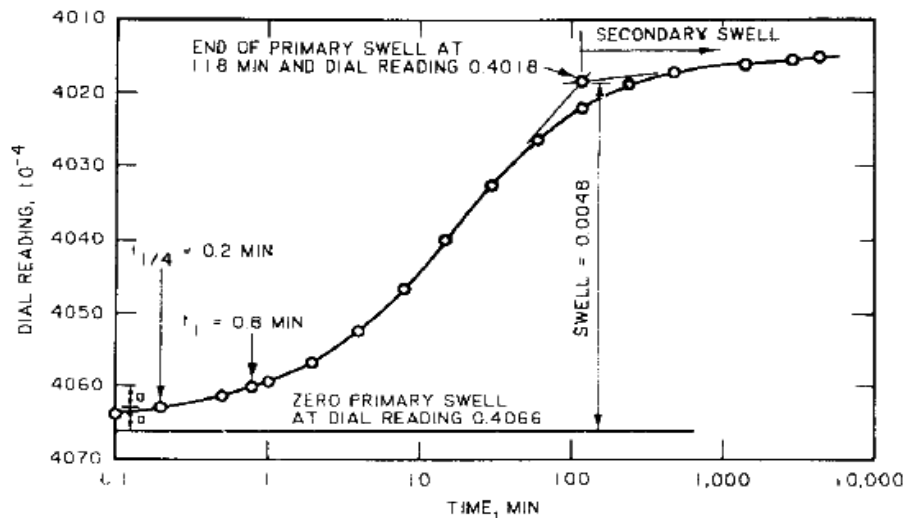

Figure 1. Dial reading versus time (ASTM D4546 (2003))

4. Factors Influencing Swelling Potential

Among the most critical factors that influence the swelling potential of expansive soils are the initial moisture content, initial dry density, clay fabric, method of compaction, compaction energy, clay mineralogy, stress path, surcharge pressure, degree of saturation and sample thickness. These factors are reviewed in the following sections.

4.1. Initial moisture content

Basma et al. (1995) performed a study to evaluate the effect of initial moisture content on the swelling pressure. Ten different soils were obtained from northern and central Jordan. Results showed that the swelling pressure decreased as the initial moisture content increased.

Du et al. (1999) noted that the formation of moisture film around the soil particles leads to an increase in the soil volume; this effect is more pronounced in samples exhibiting low moisture content where the moisture film development around the particles becomes effortless in addition to the fast buildup of the moisture film thickness reaching its maximum value in a small period.

Lamb (1958a) attributed the decrease in swelling as the initial moisture content increased to the continuous increase of the water film thickness, which leads to the reduction in the repulsive force between the soil particles, resulting in the decrease of the swelling, another factor is the formation of more dispersed structure as the moisture content increases which lessens the induced swelling. Komine and Oegata (1994), investigated the effect of initial moisture content on the swelling pressure and strain. They also explored the relationship between swelling strain and time.

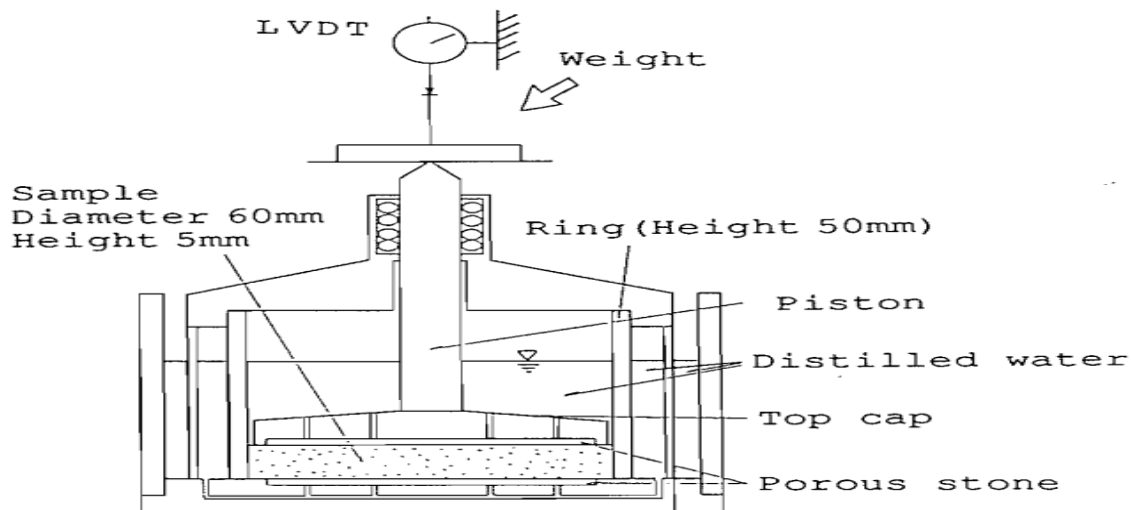

Figure 2. Swelling – deformation apparatus with improved parts (Komine and Oegata (1994)).

Compacted bentonite samples of 60 mm in diameter and 5 mm in height were tested on oedometer apparatus with some improved parts (figure 2). For various initial moisture contents at the same initial dry density it was found that the swelling strain - time relationship was almost independent of the initial moisture content at low initial dry density (1.38 Mg/m^3), while the relationship was found to be dependent on the initial moisture content at high initial dry density ($1.83 - 1.84 \text{ Mg/m}^3$). At low initial moisture content, the initial swelling - deformation rate was observed to be lower than that at high initial moisture content for samples prepared at high dry density under a vertical pressure of 5.88 kPa.

Komine and Oegata (1994), concluded that the maximum swelling strain and maximum swelling pressure were almost independent of the initial moisture content.

Villar and Lloret (2008) performed a constant volume test using oedometer apparatus on bentonite samples statically compacted in the oedometer ring to a dry density of 1.5, 1.6 and 1.7 Mg/m^3 at initial moisture contents of 17, 20 and 22%.

The tests were conducted under different vertical pressures of 0.1, 0.5, 1.0 and 3.0 MPa. The specimen dimensions were 12 mm in height and 36 mm – 38 mm in diameter.

Results showed that the initial moisture content did not affect the swelling pressure, while the swelling strain decreased as the initial moisture content increased. At a particular vertical pressure, the effect of the initial moisture content on the swelling strain is more pronounced at the highest initial dry density reached in the study (1.7 Mg/m^3).

It was also noticed that as the applied vertical pressure on the sample increases, the reducing effect of the initial moisture content on the swelling strain becomes less marked. For each initial dry density, there was a certain vertical pressure value; by exceeding it, the effect of the initial moisture content on the swelling strain was eliminated.

Rao et al. (2004), conducted swell – consolidation test method on remolded samples of black cotton expansive soils collected from 10 districts in India.

The soils were passed through a 4.75 mm sieve and oven-dried. Ten soil samples were statically compacted in four layers, each layer of 5 mm in thickness in the oedometer ring with various initial moisture contents (0, 5, 10, 15 and 20%) and several initial dry unit weights (10,

12, 14, 16 and 18 Mg/m³). The specimen dimensions were 20 mm in height and 60 mm in diameter. The tests were conducted under different initial surcharges (5, 50, 100, 150 and 200 kPa). A total of 1250 swell–consolidation tests were conducted.

Results showed that the swelling strain decreases as the initial moisture content increases due to the decrease of the soil's ability to absorb water as its saturation approaches 100%. The swelling pressure decreased as the initial moisture content increased for the ten tested soils with several dry unit weights.

Muntohar's (2003) a study was conducted by mixing variable bentonite percent with different non-swelling soils as fine sand and kaolin to obtain mixtures of bentonite-kaolin and bentonite-fine sand. The oedometer apparatus was used in testing.

The soil mixture was statically compacted in the oedometer ring with an internal diameter of 5cm and a height of 2cm at the optimum moisture content and maximum dry density.

The sample was loaded with a 3.89 kPa seating load and then inundated; after reaching stabilization values of swelling, consolidation was applied to the sample.

Mixtures of bentonite-fine sand induced higher swelling pressure than bentonite–kaolin mixtures due to the low mixing water content and high sample density of bentonite–fine sand mixture compared to bentonite–kaolin mixtures. Results showed that as the bentonite percent and the swelling potential increase, the compressibility increases this is related to the strength reduction due to water suction.

A hyperbolic relationship defines the swell manners, which can be used to estimate the maximum swelling value. The following equation may determine the rate of swelling

$$C_s = 1/t_{50}$$

Where t_{50} is the time required to reach 50% of the primary swell.

Belchior et al. (2017) conducted a study to investigate the reducing effect of lime additive on the swelling potential of Eagle Ford clay found in Texas, United States. The new geotechnical centrifuge test was utilized in the study that allows testing several specimens simultaneously quickly.

The samples were prepared at different densities and with different water content. The compaction density varied between relative compaction of 94% (RC 94%) and 100% (RC 100%) of the maximum dry density. The compaction moisture content varied between dry of optimum (DOP), optimum (OPT) and wet of optimum (WOP) moisture content.

A parameter named Swelling Potential Reduction Ratio (SPR) was presented in the study which measures the reduction of the swelling potential made by hydrated lime additive (HL) regarding to swelling potential in natural soil, while n% HL stands for percent of hydrated lime used. SPR will be zero for untreated Eagle Ford clay and will be one when the reduction in swelling potential is 100%. Equation (1) defines the SPR.

Therefore, the higher SPR is, the lime treatment can be considered more efficient.

$$SPR = 1 - \frac{Sp(n\%HL)}{Sp(0\%HL)} \quad (1)$$

Results showed the strong influence of compaction moisture content on swelling potential, where only 2% of lime was needed to seize the swelling potential for samples compacted with wet of optimum (WOP) moisture content, while 4% of lime was required to prevent swelling of

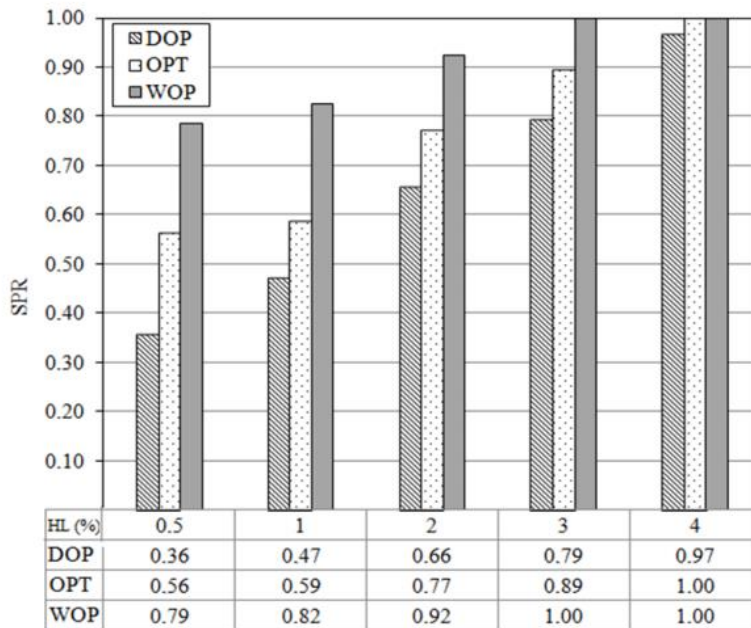

Figure 3. Swelling potential reduction ratio (SPR) at different moisture contents, (Belchior et al., (2017))

samples compacted at dry of optimum (DOP) moisture content. Figure (3) presents a histogram for the outcomes.

4.2. Initial dry density

The increase in the dry density leads to an exponential growth in the swelling pressure (Chen (1988); Fredlund and Rahardjo (1993)).

Cui et al. (2012), conducted a study on sand–bentonite mixtures where the sand contents were 0, 10, 20, 30, 40 and 50%. Dynamic and static compaction was used with mixing water content of 28% and 13% for dynamic compaction.

Results showed a difference in the nature of the time–swelling pressure relationship on testing samples having the same sand content ratio but at various initial dry densities, as the swelling rate is very slow at low-density range and increases by increasing the initial dry density.

It was observed that the swelling strain versus log time was slow at the beginning, after which it increased sharply, finally reaching an asymptotic value. The initial dry density and the sand content ratio affect the time required to reach the asymptotic value.

An exponential increase is determined between the increase in initial dry density and the maximum vertical swelling pressure, while a linear relationship is found between the swell strain and the initial dry density. Samples prepared with different sand content ratios having approximately the same initial dry density showed a continuous and significant reduction in swelling pressure as the sand content ratio increased.

An exponential decrease was observed for the maximum swelling pressure as the sand content ratio increased, while a quadratic decrease describes the relation between the sand content ratio and maximum swell strain.

The initial dry density and sand content ratio greatly affect the maximum swelling pressure and maximum swelling strain. It is concluded that the rectangular, hyperbolic relationship fits the time–swell curves.

As the dry density of compacted bentonite increased the swelling pressure increased (Pusch (1980a and b), Dixon and Gray (1985); Yong et al. (1985); Gens and Alonso (1992); and Cui et al. (2002).

Lee et al. (2012), conducted a study on samples of compacted ca – bentonite, which showed that as the dry density increased, the swelling pressure increased; this increase is more pronounced at higher densities. The increase in swelling pressure was slow till reaching a dry density of approximately 15.70 kN/m^3 , as exceeding this density, the swelling pressure increased sharply. This sharp increase after exceeding a dry density of approximately 15.70 kN/m^3 can be attributed to the anisotropic nature of the compacted bentonite samples.

Gray et al. (1985), Komine and Ogata (2004) reported the same trend for a dry density between 15.70 kN/m^3 and 16.68 kN/m^3 .

Pusch (1999), observed randomly arranged aggregates of bentonite particles (micropeds) at lower density, while above 15.70 kN/m^3 , interparticle voids generally vanish, leading to the fusion of micropeds forming a uniform sample. Lee et al. (2012) supported his explanation by pointing out the big difference between the axial and radial swelling pressure at higher dry densities compared to lower dry densities with lower difference between the axial and radial swelling pressure, as shown in Figure (4) which is due to the anisotropic nature of the compacted bentonite sample microstructure.

Basma et al. (1995) reported that the swelling pressure increased as the dry unit weight increased. Villar and Lloret (2008) said that the swelling pressure and strain increase as the initial dry density increases.

Belchior et al., (2017) performed an experimental study to evaluate the reducing effect of lime additive on the swelling potential of Eagle Ford clay found in Texas, United States. The new geotechnical centrifuge test was used in the study. The samples were prepared at different densities and with different water content. The compaction density was varied between relative compaction of 94% (RC 94%) and relative compaction of 100% (RC 100%) of the maximum dry density. Results demonstrated that higher swelling potential was observed in specimens prepared with densities near to the maximum than the specimens with lower density.

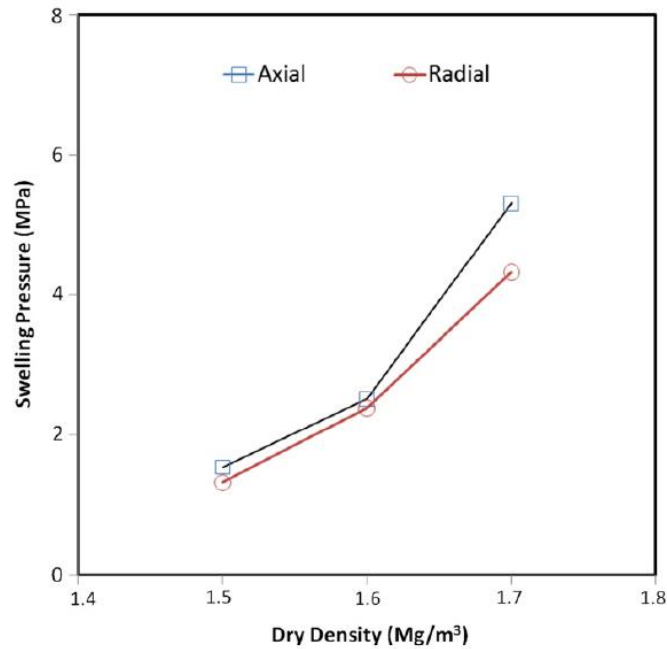

Figure 4. Axial and radial swelling pressures versus dry density (Lee et al. (2012)).

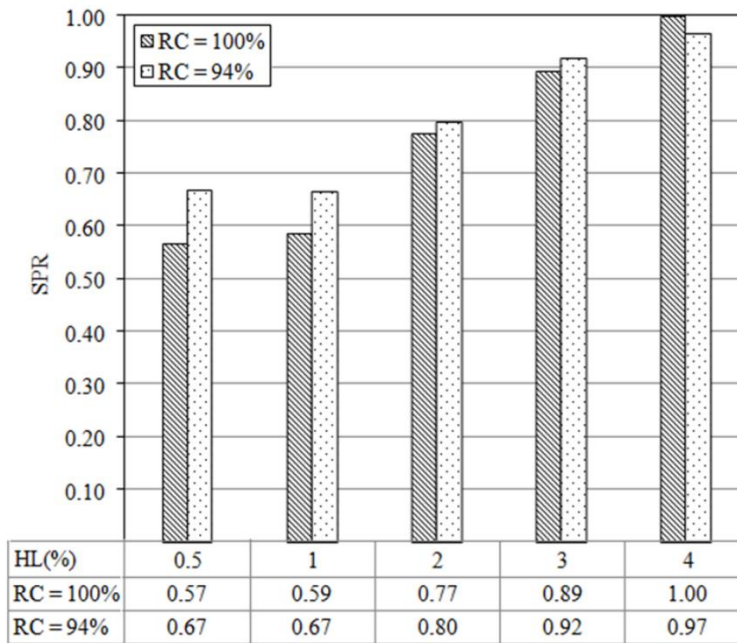

Figure 5. Effect of relative compaction on swelling potential reduction ratio (SPR) for different lime contents, (Belchior et al., (2017))

The efficiency of lime additives to reduce the swelling potential increased as the dry density decreased except for the 4% of hydrated lime. Figure (5) shows a histogram of the findings.

4.3. Clay fabric

The clay particle's orientation in the soil matrix directly affects the swelling potential of the expansive soils. Terzaghi (1931) noted the microfabric effect on soil engineering behaviour, as when testing two samples of the same clay with the same void ratio and moisture content, different swelling pressures may be induced due to the variation in the particle arrangements.

Baser (2009) reported that clays with a flocculated structure are more expansive than clays with a dispersed structure.

The orientation of the clay particles is influenced by the moulding water content and method of compaction.

Lambe (1958a); Seed et al. (1959), and Chen (1988), reported that clays compacted on the dry side of optimum had lower bulk density due to the formation of flocculated or card house fabric, while compaction on the wet side of optimum gives a more oriented arrangement of particles namely dispersed microstructure due to the fully development double layer water films.

Armstrong (2014) concluded that soils with a dispersed structure swell more and induces greater secondary swell than soils with a flocculated structure with the same moisture content.

Mokhtari and Dehghani (2012) reported that clays with flocculated structures are more expansive than clays with dispersed structures. They stated that at lower moisture content, kneading compaction creates dispersed structures, which induce low swell potential compared to static compaction.

Du et al. (1999) noted that the change in soil fabric and the breakdown of the cementing bonds due to compaction are considered the most important factors affecting the swelling pressure of compacted expansive soil. The compacted soil had their pores distributed consistently, creating channels which facilitate the water entrance to the soil particles; on the

contrary the undisturbed soil has heterogeneous pore distribution, making it more difficult for the water entrance.

Sloane and Kell (1966) studied the clay fabric orientation of the kaolinite clay at different moisture contents. The clay samples were compacted above and below the optimum moisture content by 3%. They observed a high degree of randomness at 3% dry of optimum while at 3% wet of optimum, the fabric was highly oriented.

Diamond (1971) observed a small difference in fabric arrangement by comparing samples compacted dry of optimum and wet of optimum as they had a little degree of orientation normal to the compaction axis.

Yoshinaka and Kazama (1973) concluded that the orientation of soil particles increased as the moulding moisture content increased, they said that parallel arrangements were found at optimum moisture content, while curved and folded arrangements of particles were found at dry optimum and wet optimum moisture content.

Cetin et al. (2007) conducted a study to investigate the soil fabric orientation at various moisture contents dry and wet of optimum moisture content, the samples compacted according to the standard compaction method. Three zones of the sample were inspected: top, middle and bottom.

They concluded that at the very dry stage, the pattern is random, and by increasing the moisture content, the pattern orientation increases till reaching the optimum moisture content. As the optimum moisture content is exceeded, the orientation decreases. The degree of orientation was observed to be larger at the bottom third zone at the various moisture contents compared to the other zones.

At dry of optimum moisture content particle pattern is edge to edge; near the OMC, the particle orientation is edge – face and face – face. Long strings of curved trajectories having face–face contact domains as the OMC was exceeded. The higher the moisture content, the higher the number of face–face contacts as the thicker double-layer water films developed.

Azam (2003) studied statically compacted calcium sulphate forms, field clay samples, and their synthetic mixtures using the oedometer apparatus under a vertical stress of 7 kPa. The expansive clay was brought from Al-Qatif, while the gypsum, bassanite and anhydrite were brought from Dhahran in the Kingdom of Saudi Arabia.

A scanning electronic microscope (SEM) was performed on the samples before and after inundation to investigate the influence of the fabric on the volume change. A decrease of 38% of the swelling potential is observed when gypsum replaces the clay, and a decrease of 56% occurs when anhydrite replaces the clay; this is due to the formation of the loose soil fabric for a statically compressed mixture, compared to the undisturbed clay microstructure, which is formed under natural conditions for a long period. The clay has a flocculated structure, which leads to an increase in the void ratio due to water suction, causing a high compression index in the clay.

4.4. Method of Compaction

Sloane and Kell (1966), investigated the effect of compaction methods and moulding water content on the clay fabric where kaolin cylindrical specimens were compacted by kneading, impact and static compaction methods at optimum moisture content and at 3% dry and wet optimum. Horizontal and vertical sections were prepared for electron micrographs.

For the kneading compaction method, random fabric was observed at 3% dry of optimum in the horizontal and vertical sections, while at optimum moisture content, more oriented fabric was seen in the horizontal and vertical sections.

The high degree of orientation perpendicular to the specimen axis was denoted at 3% wet of optimum for the horizontal section, while the fabrics are oriented more horizontally compared to their orientation at optimum moisture content.

For the impact compaction method, it was indicated that there was a high degree of randomness at moulding moisture content of 3% dry of optimum, compared to the corresponding kneading micrographs, the fabrics seem to be oriented more perpendicular to the cylindrical specimen axis. At 3% wet the optimum high degree of orientation was denoted.

The static compaction method showed a significant degree of fabric randomness, where fabrics were more oriented perpendicular to the cylindrical specimen axis for the horizontal section as compared to corresponding micrographs of the kneading and impact compaction method, while there was a very considerable degree of orientation in the horizontal and vertical sections at 3% wet of optimum.

Static compaction causes a decrease of 30% in the swelling potential for different clay soils (Attom et al. (2001)).

The compaction by kneading and impact can change the soil fabric from flocculated or random at low moisture content to parallel (Seed and Chan (1959)).

Dynamic compaction and static compaction produce samples with different microstructures. On comparing the static compaction and dynamic compaction, the static compaction produced higher density than the dynamic compaction because it was energy efficient (Boonsinsuk et al. (1991)).

4.5. Compaction energy

Sridharan and Gurtug (2004), conducted a study on different types of swelling soils and different compaction energies to evaluate the effect of compaction energy on the swelling pressure.

To achieve the study, three soils were taken from north Cyprus (Tuzla, Degirmenlik and Akdeniz) and two swelling clay kaolinite and montmorillonitic clay.

Three different compaction energies were used: 1) standard proctor, 2) reduced modified proctor 3) modified proctor. Samples were prepared at the maximum dry density and the optimum moisture content. Samples were extracted from the proctor mold using an oedometer ring.

The Conventional odometer apparatus was used in the study. The tests were performed by applying a pressure of 7 kPa and inundating the samples. Time versus swelling measurements were recorded for 7 to 16 days to ensure near-equilibrium is reached.

The percent swell is the amount of swell divided by the initial sample thickness, which is expressed as percentage.

All results showed that the increase in percent swell was very rapid at the initial stage and gradually reached the equilibrium level. It was observed that even after 10 days, there was a slow increase in percent swell.

The percent swell increases as the compaction energy increases. Linear relationship was obtained between the percent swell and the compaction energy. Increasing the compaction energy 4.5 times leads to the increase of percent swell 2.5 times in montmorillonite clay.

Sridharan and Gurtug (2004) concluded that there was a linear relationship between the compaction energy and the swelling pressure.

Attom (1997) conducted an experimental study on cohesive soil to investigate the effect of the compaction energy on its properties. He noticed that the swelling pressure increased as the compaction energy increased at the dry side of the optimum.

Sabat and Mohrana (2015) studied the influence of compaction energy on locally available expansive soil. Results indicated that as the compaction energy increased from 592 KJ/m³ to 2700 KJ/m³, MDD increased from 19.26 KN/m³ to 22.46 KN/m³, and OMC decreased to 13.66% from 16.43%. Based on these results, they concluded that increasing compaction energy results in an increase in the swell potential of soil.

Khan (2017) performed an experimental study on bentonite clay to investigate the influence of compaction energy on the soil properties. Table (1) presents the soil properties. Eight different compaction energies were utilized in the study that varied from 237 KJ/m³ to 1197 KJ/m³.

The swelling pressure for the tested soil samples was determined by the free swell pressure test as the samples were prepared at the OMC and the corresponding MDD.

Results showed that by increasing the compaction energy, the MDD increased from 1.61 g/cm³ to 1.75 g/cm³. This is because denser material is obtained with closer packing of soil particles. On the other hand, the OMC was reduced from 31.55% to 21.63%, which is due to the

decrease in void spaces available in soil mass. As the soil particles are packed more closely, the voids available for water accumulation are less.

The study pointed out the significant increase in the swell percent with the increase in the compaction energy. Figure (6) introduces the swell percentage values corresponding to the increase in the compaction energy. It is observed that when the compaction energy increased from 237 KJ/m³ to 1197 KJ/m³, the swell percentage increased from 0.3% to 6%. This can be related to the fact that compacting soils at the dry side of optimum decreases the permeability of soil, which increases the swell potential.

Table (1) Soil properties (Khan, 2017).

Soil Property	Value (%)
Percent of Silt	41
Percent of Clay	57
Liquid limit	126.2
Plastic limit	83.5

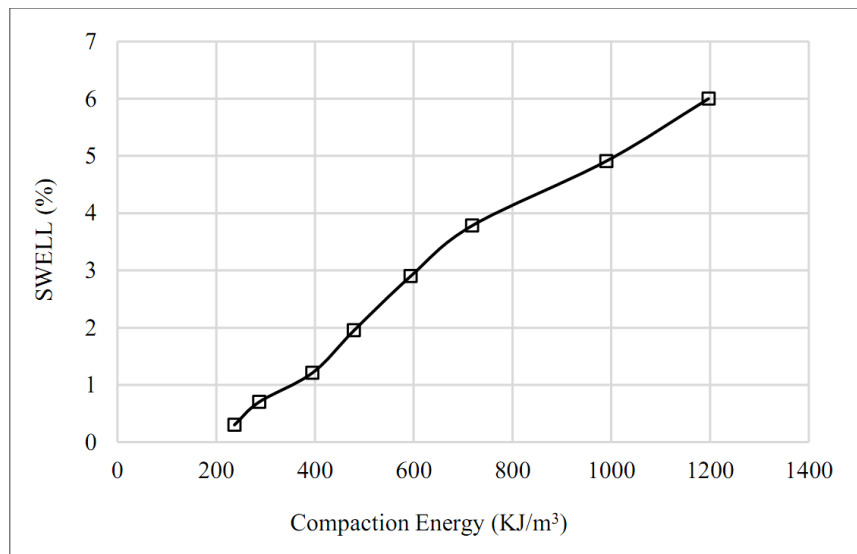

Figure 6. Swell percent versus the compaction energy (Khan (2017))

4.6. Clay mineralogy

The clay particle mineralogy determines the degree of clay expansiveness; illite, kaolinite and montmorillonites are the mainly important clay minerals (Chen (1988)).

Azam (2003), investigated the effect of soil mineralogy on swelling and consolidation by laboratory testing on calcium sulphate forms, field clay samples, and their synthetic mixtures using the oedometer apparatus under a vertical stress of 7 kPa. The samples were compacted statically.

Results showed that material type affects the amount of expansion and compression. Anhydrite induced the highest swelling potential between the calcium sulphate forms, followed by bassanite and gypsum.

Sridharan and Gurtug (2004) performed an experimental study using three soils from north Cyprus (Tuzla, Degirmenlik and Akdeniz) in addition to kaolinite and montmorillonitic clay. Several compaction energies were used to conduct standard, reduced modified, and modified proctor tests.

The samples were prepared at the maximum dry density and the optimum moisture content. The oedometer ring was used to extract the samples from the proctor mould to be tested in the oedometer apparatus under vertical pressure of 7 kPa. Time–reading were recorded till near-equilibrium is reached.

Results showed that kaolinite reached equilibrium in less than 24 hours, while montmorillonitic clay took 7 days. It was observed that more time is required to reach equilibrium as the plasticity index increases.

The percent swell increased from kaolinite to montmorillonitic clay, demonstrating the clay mineralogy effect. As the dry density increases the percent swell increases, but in the study the effect of clay mineral is more pronounced as the montmorillonitic induced the highest percent swell while having a lesser initial dry density. The kaolinite clay gave less percent swell despite having a higher density. The three Cyprus soils showed variation concerning the percent swell.

It is well known that the clay mineralogy has a predominant effect on the soil atterberg limits. Soils having higher liquid limit and plasticity index induces larger percent swell. Results indicated that as the plasticity of the soil increases the slope of the curve relating percent swell with log – time in the initial, primary and secondary swell increases.

The rate of secondary swelling can be defined as the relationship between the percent swell and the log t in the plot relating them as introduced in equation (1)

$$C_{\alpha s} = \frac{\Delta(\delta H_s/H)}{\Delta \log_{10} t} \quad (1)$$

Where ΔH_s is the ratio of secondary swelling, H is the sample height from t1 to t2.

The rate of secondary swelling increased from 0.0123 on using standard proctor compaction to 0.0179 using modified proctor compaction for testing montmorillonitic clay with a plasticity index of 58, while for Degirmenlik clay with a plasticity index of 12.1, the rate of secondary swelling was 0.00124 for standard proctor compaction and 0.00495 for modified proctor compaction.

Bowels (1988) investigated the relationship between the plasticity index and the swelling potential. The swelling potential is defined as the percentage of a swell of soil tested in an oedometer apparatus, which is soaked under a surcharge load of 7 kPa (1 lb/in²) after being compacted to maximum dry density at optimum moisture content according to AASHTO compaction test.

He reported that as the plasticity index increased the swelling potential increased. This finding was summarized in table (2).

Table (2) Relationship between Plasticity index and swelling potential (Bowels, 1988).

Plasticity Index, (%)	Swelling Potential, (%)
0 – 15	Low
10 – 35	Medium
20 – 55	High
35 and above	Very High

Pitts (1984) and Kalantari (1991) reported a direct relationship between the atterberg limits and the soil swelling potential. Table (3) introduces these outcomes.

Table (3) Relationship between atterberg limits and swelling potential (Pitts, 1984; Kalantari, 1991).

Liquid Limit, (%)	Plasticity Index, (%)	Swelling Potential, (%)
<50	<25	Low
50 – 60	25 – 35	Marginal
>60	>35	High

Seed et al. (1962) suggested a linear relationship between swell percent, S under a surcharge of 6.9 kPa and plasticity index, PI as shown in equation (1):

$$S = 2.6 \times 10^{-3} (PI)^{2.44} \quad (1)$$

Seed et al. (1962) provided an additional expression for swell percent, S in terms of activity, A and clay content, C as introduced in equation (2):

$$S = 3.6 \times 10^{-5} (A)^{2.44} (C)^{3.44} \quad (2)$$

Nayak and Christensen (1974) found that the swell potential of expansive soils is best related to the plasticity index, clay content, and water content. They gave a statistical relationship for the swelling potential as presented in equation (3).

$$S = 2.9 \times 10^{-2} (PI)^{1.45} \times (C/w_i) + 6.39 \quad (3)$$

Where; C , stands for the clay content, and w_i , stands for the initial water content.

Cui et al. (2012) reported that on preparing and testing sand–bentonite mixtures, the change in sand content ratio greatly affects the maximum swell pressure than the maximum swell strain as it alters the bentonite percent.

4.7. Testing Methods Stress Path

Al – Mhaidib (1999) performed laboratory testing on expansive soil samples collected from a test pit at a depth of about 3 m excavated at Al – Ghatt town in the Kingdom of Saudi Arabia, where more than 400 one-story residential buildings constructed of rigid reinforced concrete frames suffered from cracks.

Three odometer testing methods were performed: free swell, constant volume swell and swell overburden, also, the stress path triaxial apparatus was used in the swell tests. Five vertical pressures were used in the swell overburden test method.

The dried crushed samples passing sieve No. 40 were mixed with 22% moisture content and compacted to an initial dry unit weight of 18 kN/m^3 in the oedometer ring with a 70 mm diameter and a height of 19 mm.

The triaxial specimens were compacted statically at the same initial moisture content and dry unit weight with a diameter of 35.5 mm and 71 mm in length.

Five confining pressures had values the same as the vertical pressure values used in the overburden test method.

Results showed that the free swell method induced the highest pressure and strain while the swell overburden method induced the lowest pressure and strain. Intermediate values were obtained using the constant volume method.

The swell overburden method is advantageous as the expected field stress pass is followed, while the free swell method is considered time-consuming. The observed differences in the results between the testing methods on using the oedometer apparatus are attributed to the different stress passes followed for each testing method regarding the wetting and loading conditions.

The induced vertical swell strain from the oedometer tests was greater than that induced from the triaxial tests for all the applied stresses. This is attributed to the difference in the followed stress paths for the oedometer and triaxial tests (wetting and loading conditions) and the permitted direction for the sample to swell as it is laterally restrained in the oedometer tests.

Another factor was the difference in wetting for the two apparatuses. It was noticed that the ratio of the triaxial swell strain to the oedometer swell strain was one-third. This was related to the fact that the triaxial test resembles the field conditions as the swelling occurs in three dimensions compared to one dimension of the oedometer test.

Gizienski and Lee (1965); Dhowian (1990), and Erol (1992), reported that the field heave was overestimated on using the oedometer results by a factor of three. The swell overburden method represents actual in situ loading and wetting condition (El Sayed and Rabbaa (1986)).

Several experimental methods, namely constant – -volume method, zero–swell method, swell–consolidation method and pre–swell method, were conducted on statically compacted samples at a rate of 0.05 mm/min for bentonite and claystone powder mixture having bentonite content of 70% in dry mass. In the “pre-swell” method, the sample was first allowed to swell freely in the axial direction to a certain value; then the piston was fixed, permitting the generation of swelling pressure monitored by the load transducer.

Results revealed a logarithmic relationship between the swelling pressure and the final dry density, showing an increase in the swelling pressure as the final dry density increased. For the pre–swell test method, the swelling pressure decreased significantly as the pre–swell strain increased. It was also observed that various changes in the matrix microstructure occurred due to loading–wetting conditions as the stress path differed for the various testing methods, which directly affected the swelling pressure since the obtained swelling pressure from various testing methods at the same void ratio was a bit lower than required pressure to reach the same void ratio for the swell – consolidation method. (Wang et al. (2012)).

4.8. Surcharge pressure

The reducing effect of the surcharge pressure on the expansive soil volumetric increase is a well-known fact. Chen (1988), stated that when applying a pressure of 1000 psf and inundating the clay sample it induced a swelling pressure of 12000 psf and a volume increase of 5.9% while applying a surcharge pressure of 5000 psf induced a volume increase of 1.6%, but it gave the same swelling pressure.

Bensallam et al. (2013), experimentally investigated the effect of the surcharge pressure on the cyclic deformations of the expansive soil by testing ten samples with dimensions of 7 cm in diameter and 2 cm in height on the oedometer apparatus.

Five surcharge pressures (0, 70, 140, 280 and 350 kPa) were utilized in the study by testing two samples under each pressure. Three drying and wetting cycles were applied to the samples

by first recording the deformations under the applied pressures at dry conditions till stabilization; then the samples were inundated with measurements taken with time till reaching equilibrium, after which the oedometer cell was emptied from water and the drying stage was started at 25 °C associated with deformation – time recordings, drying and wetting cycles were repeated three times.

Results showed that the period of each cycle decreased gradually as the cycle number and the applied load increased. It was observed that as the applied load increases the axial deformations decrease gradually, and the curve shape have a propensity to flatten for the large applied load. The swell strain showed a step reduction as the applied pressure increased from 0 to 350 kPa, for the first and third cycles the reduction reached about 90% by applying the 350 kPa pressure, while for the second cycle, the reduction was 86%.

It was noted that the applied pressure significantly affects the stabilization of soil deformation. This is related to the less water adsorption rate as the pressure increases, as the range of change in moisture content increases compared to the initial moisture content the swelling deformation increases.

Estabragha et al. (2013), performed an experimental study by mixing bentonite with kaolinite and testing them in a modified oedometer apparatus.

The mixture was prepared at 13.5% moisture content, which was dry at optimum and compacted statically to a dry unit weight of 15.70 kN/m³.

Results showed that after inundation and equilibrium, specimens loaded with a surcharge pressure of 10 kPa induced a volumetric strain of 29.90% while specimens loaded with a surcharge pressure of 20 kPa induced a volumetric strain of 18.50%, indicating that the surcharge pressure controls the swell potential.

Lee et al. (1983), reported that as the foundation pressure increases, the swell of the active supporting soil decreases.

Rao et al. (2024) conducted an experimental investigation on 10 remolded expansive soil samples collected from 10 districts of Andhra Pradesh, India. All the soils were black cotton soils.

Results showed that as the initial surcharge increased, the swell potential decreased. This is related to decreasing the void ratio and reduced ability of the soil to absorb water. Nevertheless, the swelling pressure was not influenced by the initial surcharge. This observation agrees with the observations of Chen (1988). Figure (7) presents the relationship between the swelling pressure and the surcharge.

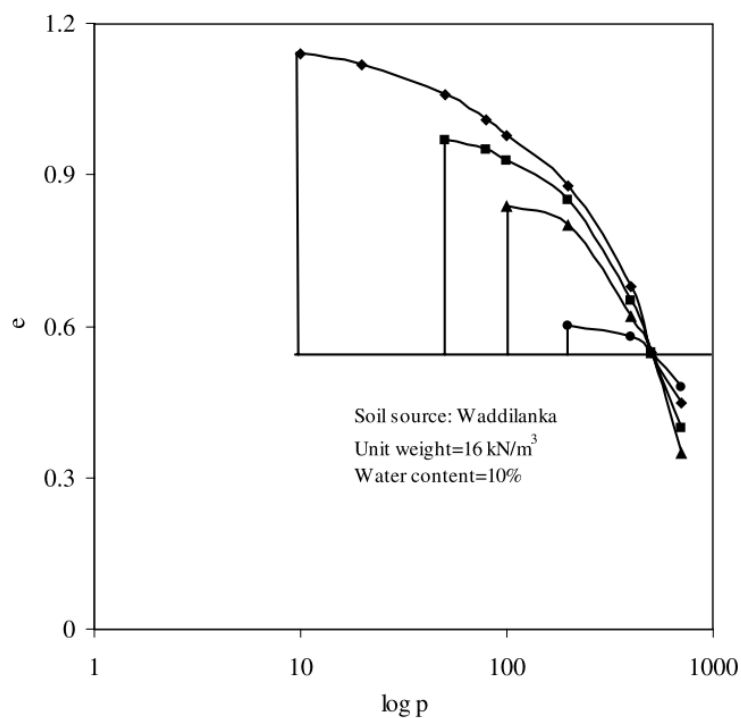

Figure 7. Swelling pressure versus the surcharge (Rao et al. (2024))

4.9. Degree of saturation

Chen (1988), reported that by varying the degree of saturation of several compacted specimens having the same initial moisture content and density tested in the oedometer the vertical swelling pressure was not affected, but a direct proportion was observed between the volume change and the degree of saturation.

Chen (1988), noted that the same heavy damage can occur to lightly loaded structures for short and long wetting durations because the swelling pressure stays constant irrespective of the degree of saturation.

Borgesson (1985), conducted an experimental study using the LuH swelling pressure oedometers to investigate the effect of the degree of saturation on the swelling pressure. Sodium bentonite samples with different dry densities and degrees of saturation were studied. The sample height was 2 cm, and it was totally dry at the beginning of the test. Results showed that the swelling pressure is directly proportional to the degree of saturation. Figures (8 and 9) show the swelling pressure versus the degree of saturation for Na bentonite samples with dry densities of 1.76 and 1.57 t/m³ respectively.

It was observed that the swelling pressure did not increase linearly with time during water absorption, which is demonstrated in Figure (9) which relates the swelling pressure and time for Na bentonite sample having a dry density of 1.47 t / m³ and a degree of saturation of 45%.

Ito (2010), conducted an experimental study on glacio-lacustrine clay in Regina City using the standard oedometer. Free swelling and swell–shrink tests were performed in accordance to ASTM (D 4546) (2003), Method A and ASTM (D 4943) (2003) to determine the swelling and shrinkage properties of the undisturbed expansive soil.

Results obtained from the free swell test performed under a seating pressure of 1.5 kPa showed a swell potential of 1.5%. Ito (2010), attributed this low value to the high initial saturation, which reduced the ability of the soil to absorb water. The Swell – Shrinkage test was performed by wetting the samples so as to reach a fully saturated sample (S = 100 %), and then several suction values were applied to desaturate the samples.

From the Swell – Shrinkage test, a graph relating the void ratio and the water content is constructed as shown in Figure (10). Saturation values of 100, 82, 80, 60 and 0% corresponding to wet, field, plastic limit, shrinkage limit and desiccated conditions were calculated from the void ratio– water content relation presented in Figure (11). The swelling pressure corresponding to each soil condition was determined by plotting the void ratios relevant to the calculated saturation values in Figure (12), constructing horizontal lines till intersecting the compression curve, and then extending a vertical line to obtain the swelling pressure. The swelling potential corresponding to each saturation value was determined by getting the difference between the

plotted void ratio considered the initial void ratio for the considered soil condition and the final void ratio reached from the free swell test and dividing it by $(1 + e_0)$.

As the initial saturation decreased, the swelling pressure and swelling potential increased. Table (4) summarizes the swelling pressure and potential values corresponding to the initial saturation. Ito (2010) pointed out that the swelling pressure increased from 27 to 2500 kPa on decreasing the saturation from 80 (at plastic limit) to 60% (at shrinkage limit while the swelling potential increased 12 times.

Table 4. Induced swelling pressures and potential corresponding to initial saturation (Ito (2010))

Soil condition	Initial saturation (%)	Swelling pressure (kPa)	Swelling potential (%)
Wet	100	0	0
Field	82	3.5	1.5
Plastic limit	80	27	2.0
Shrinkage limit	60	2500	24
Desiccated	0	12000	35

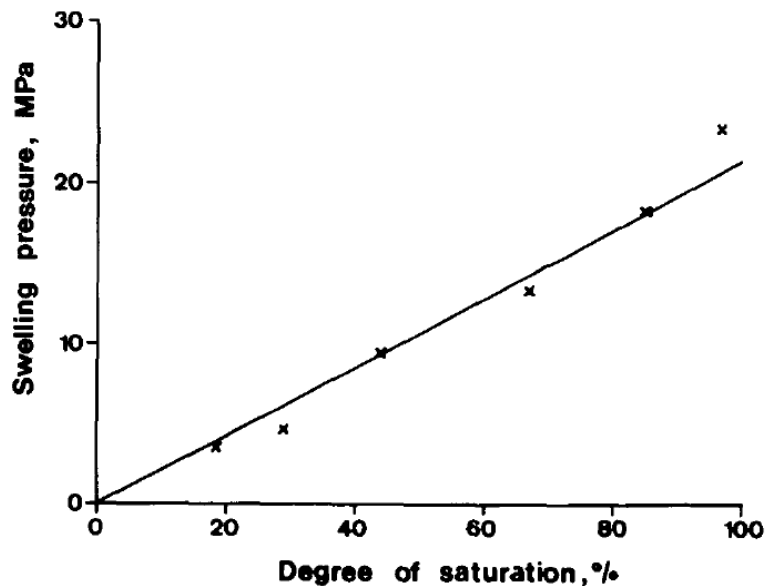

Figure 8. Swelling pressure versus degree of saturation for Na bentonite sample with a dry density of 1.76 t / m^3 (Borgesson (1985))

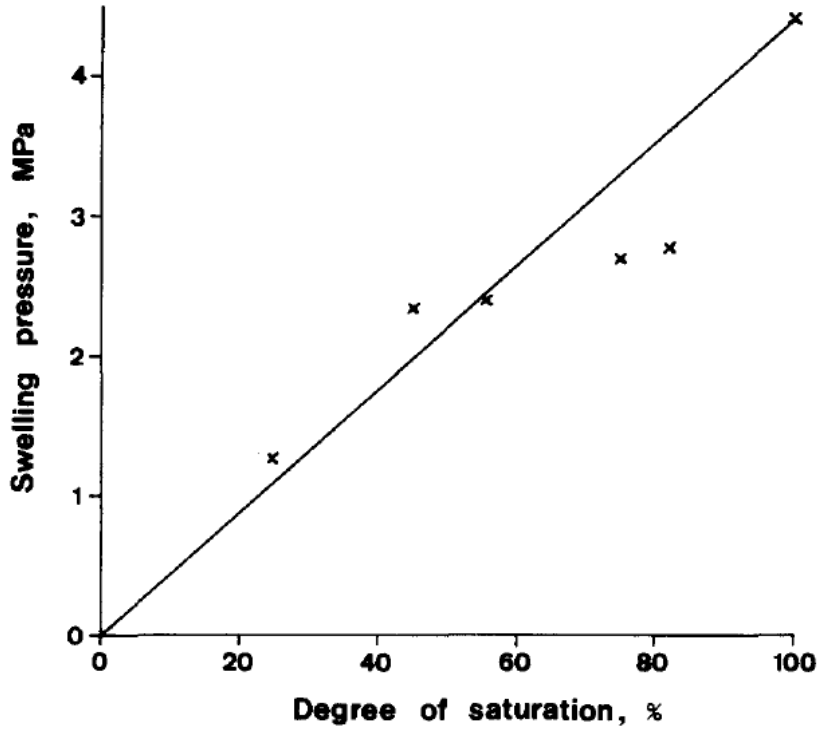

Figure 9. Swelling pressure versus degree of saturation for Na bentonite sample with dry density of 1.57 t / m^3 (Borgesson (1985))

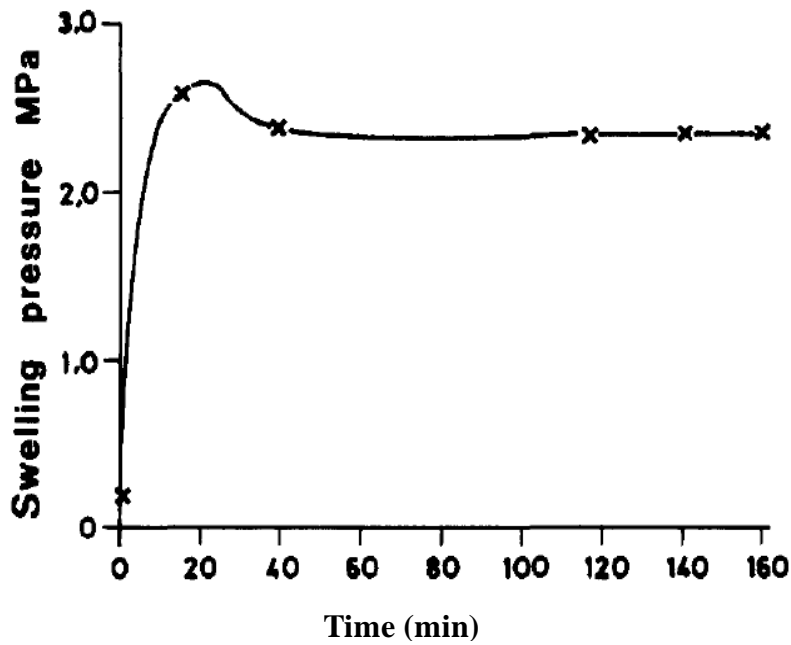

Figure 10. Swelling pressure versus time for Na bentonite sample with dry density of 1.47 t / m^3 and a degree of saturation of 45 % (Borgesson (1985))

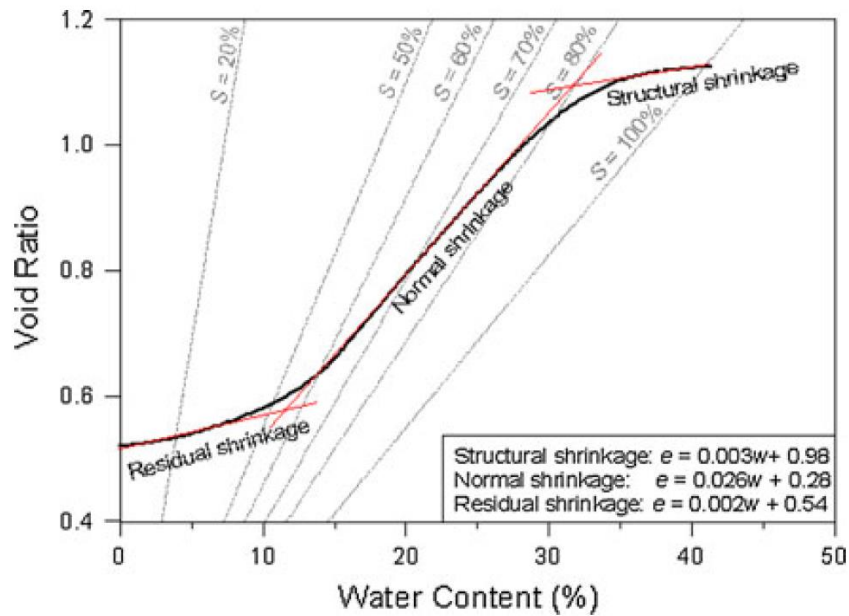

Figure 11. Void ratio – water content relationship (Ito (2010))

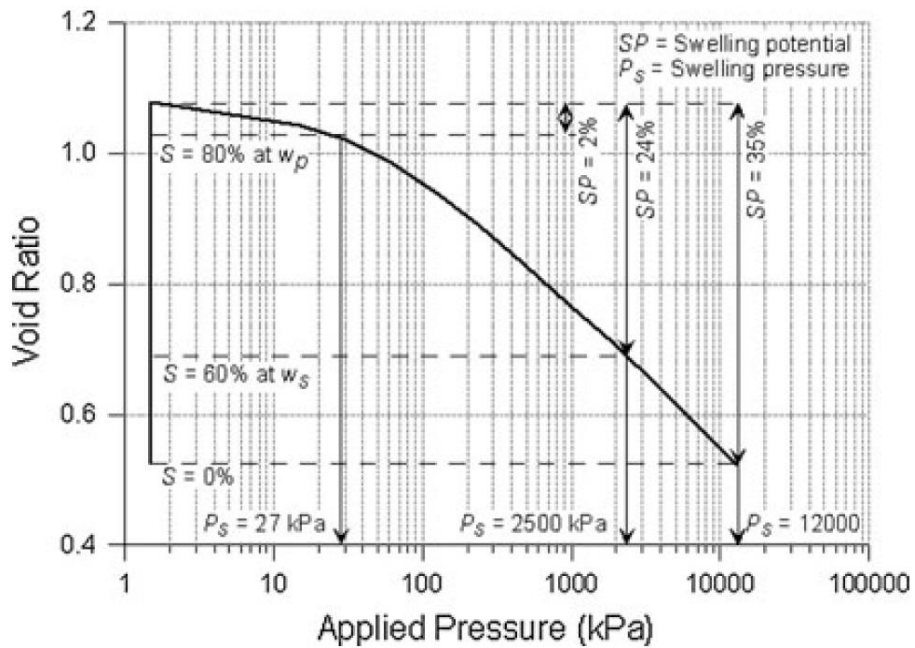

Figure 12. Free swell curve, the swelling pressures and potentials corresponding to different saturation values (Ito (2010))

5. Conclusion

- 1) Expansive soils swell vertically and laterally as the moisture content increases, inducing swelling pressures and strains, damaging structures and causing distress to roadways.
- 2) The increase in initial moisture content considerably decreases the soil swelling potential due to the decrease of the soil's ability to absorb water as its saturation approaches 100%.
- 3) The increase in the initial dry density significantly increases the swelling pressure and swelling strain.
- 4) The orientation of clay particles in the soil matrix directly affects the swelling potential of the expansive soils.
- 5) Clays with a flocculated structure are more expansive than clays with a dispersed structure.
- 6) Compaction method influences the soil swelling potential as it affects the particle orientation in the soil mass.
- 7) A linear relationship exists between the compaction energy and the swelling potential.
- 8) The clay mineralogy has a predominant effect on the swelling potential.
- 9) As the surcharge increases, the swelling potential decreases due to the lower water adsorption.

6. Discussion

Deep understanding of the swelling mechanism and factors influencing its potential is the success key for the geotechnical engineer to select a suitable treatment measurement to alter its detrimental effects by modifying its influencing factors, consequently making aired areas more feasible for construction purposes.

The compaction moisture content has a great impact on the soil swelling potential. This can be beneficial when utilizing a mixing treatment technique to the soil. Thus a treatment measurement by mixing and compacting the soil with an additive at wet of optimum moisture content instead of dry of optimum moisture content will lead to the required treatment result with

the lowest percent of additive compared to the usage of dry of optimum moisture content which needs more additive percent to reach the same result, therefore reducing the remedial cost.

Previous works demonstrated the inverse relationship between the dry density and the swelling potential. This can be beneficial in increasing the efficiency of the mixing additive when using the mixing treatment technique by lowering the dry density of the treated soil and reaching better results.

The clay fabric has a pronounced effect on the swelling potential, where clays with a flocculated structure are more expansive than clays with a dispersed structure. Knowing that the orientation of the clay particles is influenced by the moulding water content and method of compaction, a flocculated structure can be reached by modifying the moulding water content and selecting a suitable compaction method, which will result in lowering the soil swelling potential that will enhance the treatment additive efficiency.

In addition to that, clays with a flocculated structure have a lower bulk density, which lowers the soil swelling potential.

The compaction method and moulding water content have a pronounced effect on the clay fabric, directly affecting the soil swelling potential. In order to reach the lowest swelling potential that can be later eliminated using a suitable treatment measure, the geotechnical engineer should select the compaction method and moulding water content that makes the clay particles flocculate.

It was noticed that there was a linear relationship between the compaction energy and the swelling pressure. Thus, heavily compacted expansive soils are not considered a good practice.

It was noted that the applied pressure significantly affects the soil swelling potential. This is related to the less water adsorption rate as the pressure increases, as the range of change in moisture content increases compared to the initial moisture content, the swelling deformation increases.

Accordingly, the geotechnical engineer must consider the oncoming stresses on the swelling soil, whereas as the foundation pressure increases the swell of the active supporting soil

decreases. Thus, correlating the foundation pressure with the soil swelling pressure and strain is vital when selecting treatment measurements and recommending the foundation pressure.

The initial moisture content has a pronounced effect on the swelling potential as the initial moisture content increases, the swelling potential decreases. This is attributed to the decrease of the soil's ability to absorb water as its saturation approaches 100%. This should be considered when selecting the treatment technique, where more effective treatment techniques are to be utilized for soils with low saturation.

The thickness and location of the expansive soil strata dictate the treatment technique to be followed, whether it is soil replacement, mixing or reinforcement inclusion treatment technique.

7. References

- [1] A.S. Rao, B.R. Phanikumar & R.S. Sharma, 2024, "Prediction of swelling characteristics of remoulded and compacted expansive soils using free swell index", *Engineering Geology and Hydrogeology*, Vol. 37, pp. 217–226.
- [2] Al – Mhaidib, A., 1999, "Swelling Behavior of Expansive Shales from The Middle Region of Saudi Arabia", *Geotechnical and Geological Engineering*, Vol. 16, pp. 291 – 307.
- [3] Armstrong, Zornberg, J. and Gilbert, R., 2014, "Effect of Fabric on The Vertical swelling of Highly Plastic Clays", Master of Science, University of Texas, Austin.
- [4] ASTM D4546-03, 2003, "Standard Test Methods for One-Dimensional Swell or Settlement Potential of Cohesive Soils"
- [5] ASTM D4943-03, 2003, "Standard Test Methods for One-Dimensional Swell or Settlement Potential of Cohesive Soils"
- [6] Attom, M. F. The effect of compactive energy level on some soil properties. *Applied Clay Science*, 1997, 12(1-2), 61-72.

- [7] Attom, M.F., Abu – Zreig, M.M. and Obaidat, M.T., 2001, "Changes in Clay Swelling and Shear Strength Properties with Different Sample Preparation Techniques", *Geotechnical Testing Journal*, Vol. 24, pp. 157 – 163.
- [8] Azam, S., 2003, "Influence of Mineralogy on Swelling and Consolidation of Soils in Eastern Saudi Arabia", National Research Council, Canada.
- [9] Baser, O., 2009, "Stabilization of Expansive Soils Using Waste Marble", a Thesis Submitted to the Graduate School of Natural and Applied Sciences of Middle East Technical University.
- [10] Basma, A. A., Al – Homoud, A. S. and Malkawi, A. H., 1995 " Laboratory Assessment of Swelling Pressure of Expansive Soils", *Applied Clay Science*, Vol.9, pp.355-368.
- [11] Belchior, Casagrande and Zornberg, 2017, "Lime treatment of an expansive soil for swelling potential reduction", *Proceedings of the 19th International Conference on Soil Mechanics and Geotechnical Engineering*, Seoul, 2017.
- [12] Bensallam, S., Bahi, L., Alaoui, M., Ejjaouani, H., and Shakhirev, V., 2013, " The effect of surcharge pressure on the cyclic vertical deformations for expansive clayey soils in Morocco", *Geosciences Journal*.
- [13] Boonsinsuk, P., Pulles, B. C., Kjartanson, B. H., Dixon, D. A., 1991, "Prediction of Compactive Effort for a Bentonite - Sand Mixture", 44th Canadian Geotechnical Conference, Vol. 2, Canadian Geotechnical Society, Montreal, Canada, pp. 64.1 – 64.12.
- [14] Boonsinsuk, P., Pulles, B. C., Kjartanson, B. H., Dixon, D. A., 1991, "Prediction of Compactive Effort for a Bentonite - Sand Mixture", 44th Canadian Geotechnical Conference, Vol. 2, Canadian Geotechnical Society, Montreal, Canada, pp. 64.1 – 64.12.
- [15] Borgesson, L., 1985, "Water Flow and Swelling Pressure in Non-Saturated Bentonite - Based Clay Barriers", *Engineering Geology*, Vol. 21, pp. 229 – 237.
- [16] Bowels, J.E., 1988, "Foundation Design and Analysis", McGraw Hill Inc., New York, U.S.A.
- [17] Cetin, H., Fener, M., Soylemez, M. and Gunaydin, O., 2007, "Soil Structure Changes During Compaction of a Cohesive Soil", *Engineering Geology*, Vol. 92, pp. 38-48.

- [18] Chen, F.H., 1988, "Foundations on Expansive Soils", 2nd edition, Elsevier, Amsterdam.
- [19] Cui, S.L., Zhang, H.Y., Zhang, M., 2012, "Swelling Characteristics of Compacted GMZ Bentonite - Sand Mixtures as a Buffer / Backfill Material in China", *Engineering Geology*, Vol. 141-142, pp. 65-73.
- [20] Cui, Y.J., Yahia-Aissa, M., Delage, P., 2002, "A model for the volume change behavior of heavily compacted swelling clays", *Engineering Geology*, Vol. 64, pp. 233–250.
- [21] Dafalla, M. A. and Al – Shamrani, M. A., 2011 "Swell Rate and Aging Effects on a Bentonite Sand Mixture", Kasetsart University, Thailand.
- [22] Dhowian, A.W., 1990, "Field Performance of Expansive Shale Formation", *Journal of King Abdulaziz University (Engineering Sciences)*, Vol. 2, pp. 165 -182.
- [23] Diamond, S., 1971, "Microstructure and Pore Structure of Impact-Compacted Clays", *Clays and Clay Minerals*, Vol. 19, pp. 239-249.
- [24] Dixon, D.A. and Gray, M.N., 1985, "The engineering properties of buffer material — research at Whiteshell Nuclear Research Establishment", AECL TR-350, pp. 513–529.
- [25] Domitrović D., Kovačević Z. B., 2013, "The relationship between swelling and shear strength properties of bentonites", *Proceedings of the 18th International Conference on Soil Mechanics and Geotechnical Engineering*, Paris.
- [26] Du, Y., Li, S. and Hayashi, S., 1999, "Swelling – Shrinkage Properties and Soil Improvement of Compacted Expansive Soil, Ning – Liang Highway, China", *Engineering Geology*, Vol. 53, pp.351 - 358.
- [27] El Sayed, S.T. and Rabbaa, S.A., 1986, "Factors Affecting Behavior of Expansive Soils in The Laboratory and Field – A Review", *Geotechnical Engineering*, Vol. 17, pp. 89 – 107.
- [28] Erol, A.O., 1992, "In – situ and Laboratory Measured Suction Parameters for Prediction of Swell" in *Proceedings of the Seventh International Conference on Expansive Soils*, Dallas, TX, pp. 30-32.

- [29] Estabragha, A., Moghadasa, M., and Javadib, A., 2013, "Effect of different types of wetting fluids on the behaviour of expansive soil during wetting and drying", *Soils and Foundations*, Vol. 53, No., 5, pp. 617 – 627.
- [30] Fredlund, D.G. and Rahardjo, H., 1993, "Soil Mechanics For Unsaturated Soils", Wiley Publications, New York.
- [31] Gens, A. and Alonso, E., 1992, "A framework for the behavior of unsaturated clay", *Canadian Geotechnical Journal*, Vol. 29, pp. 1013–1032.
- [32] Gizienski, S.F. and Lee, L.J., 1965, "Comparison of Laboratory Swell Tests to Small Scale Field Tests", *Proceedings of the International Research, Engineering Conference on Expansive Clay Soils*, Texas, pp. 108 – 119.
- [33] Gray, M.N.S., Cheung, C.H., Dixon, D.A., 1985, "Swelling pressures of compacted bentonite/sand mixtures", *AECL TR-350*, pp. 776–785. Canada.
- [34] Ito, M. and Azam, S., 2010, "Determination of Swelling and Shrinkage Properties of Undisturbed Expansive Soils", *Geotechnical and Geological Engineering*, Vol. 28, pp. 413 – 422.
- [35] Kalantari, B., 1991, "Construction of foundations on expansive soils", M.Sc. of Thesis, Civil Engineering University of Missouri Columbia, Missouri, U.S.A.
- [36] Komine, H. and Ogata, N., 1994, "Experimental study on swelling characteristics of compacted bentonite", *Canadian Geotechnical Journal*, Vol. 31, pp. 478 – 490.
- [37] Komine, H., Ogata, N., 2004. "Predicting swelling characteristics of bentonites", *Geotechnical and Geoenvironmental Engineering*, Vol. 130, No. 8, pp. 818–829.
- [38] Lambe, T. W., 1958a "The Structure of Compacted Clay", *Journal of the Soil Mechanics and Foundations Division. Proceedings of the ASCE*, Paper 1654, Vol. 84, No. SM 2, pp. 1-34.
- [39] Lee I., Ingles O., and White W., 1983, *Geotechnical engineering*. Massachusetts: Pitman Publishing Incorporation, 1983.
- [40] Lee, J. O., Lim, J. G., Kang, I. M., Kwon, S., 2012, "vertical swelling Pressures of Compacted Ca – Bentonite ", *Engineering Geology*, Vol. 129 – 130, pp. 20-26.

- [41] Mokhtari, M. and Dehghani, M., 2012, "Swell – Shrink Behavior of Expansive Soils, Damage and Control", *Electronic Journal of Geotechnical Engineering*, Vol. 17
- [42] Muntohar, A. S., "Swelling and Compressibility Characteristics of Soil – Bentonite Mixtures", *Dimensi Teknik Sipil*, Vol. 5, No. 2 Sept., 2003, pp. 93 -98.
- [43] Nayak, N.V. and Christensen, R.W. 1974, "Swelling Characteristics of Compacted Expansive Soils", *Clays and Clay Minerals*, Vol. 19, No. 4, pp. 251–261.
- [44] Pitts, J., 1984, "A Manual of Geology for Civil Engineering", Halsted Press Book, Singapore.
- [45] Pusch, R., 1980a., "Water uptake migration, and swelling characteristics of unsaturated and saturated highly compacted bentonite ". SKBF/KBS, Teknisk Rapport 80-11.
- [46] Pusch, R., 1980b., "Swelling pressure of highly compacted bentonite ". SKB TR-80-13, Sweden.
- [47] Pusch, R., 1999, "Microstructural evolution of buffers", *Engineering Geology*, Vol. 5, pp.33–41.
- [48] Rao, A.S., Phanikumar, B.R. and Sharma, R.S., 2004, " Prediction of swelling characteristics of remoulded and compacted expansive soils using free swell index", *Quarterly Journal of Engineering Geology and Hydrogeology*, Vol. 37, pp. 217 – 226.
- [49] Sabat, A. K., & Moharana, R. K., (2015). "Effect of Compaction Energy on Engineering Properties of Fly Ash–Granite Dust Stabilized Expansive Soil". *Civil Engineering Journal*.
- [50] Sadam Khan, (2017), "Effect of Compaction Energy on Engineering Properties of Expansive Soil", *Civil Engineering Journal*.
- [51] Sánchez, M., Gens, A., Guimaraes, L.D., Olivella, S., 2005, "A double structure generalized plasticity model for expansive materials". *International Journal for Numerical and Analytical Methods in Geomechanics*, Vol. 29, No. 8, pp. 751–787.
- [52] Seed, H. B., Woodward, R.J., and Lundgren, R. 1962, "Prediction of swelling potential for compacted clays", *J. ASCE, Soil Mechanics and Foundation Division*, Vol. 88, No. SM-3, Part 1, pp. 53-87.

- [53] Seed, H. B., and Chan, C. K., 1959, "Structure and Strength Characteristics of Compacted Clays", *Journal of the Soil Mechanics and Foundations Division, Proceedings of the ASCE*, Vol. 85, No. SM 5, pp. 87-128.
- [54] Sivapullaiah, P. V., Sridharan, A., and Stalin, V. K., 1996, " Swelling Behaviour of Soil – Bentonite Mixtures", *Canadian Geotechnical Journal*, Vol. 33, pp. 808 – 814.
- [55] Sloane, R. L., Kell, T.R., 1966, "The Fabric of Mechanically Compacted Kaolin", *Clays and Clay Minerals, Proceedings of the Fourteenth National Clay Conference*, pp. 289-296.
- [56] Sridharan, A. and Gurtug, Y, 2004, "Swelling behaviour of compacted fine-grained soils", *Engineering Geology*, Vol. 72, No.1, pp. 9-18.
- [57] Terzaghi, K., 1931, "The Influence of Elasticity and Permeability on The Vertical swelling of Two – Phase Systems", *Colloidal Chemistry*, Vol. 3, pp. 65 – 88.
- [58] Villar, M. V., Lloret, A., 2008, "Influence of Dry Density and Water Content on The Swelling of a Compacted Bentonite", *Applied Clay Science*, Vol. 39, No. 1 – 2, pp. 38 – 49.
- [59] Wang, Q., Tang, A., Jun Cui, Y., Delage, P. and Gatmiri, B., 2012, "Experimental Study on the Swelling Behavior of Bentonite / Claystone Mixture", *Engineering Geology*, Vol. 124, pp. 59 - 66.
- [60] Yong, R.N., Boonsinsuk, P., Wong, G., 1985, "Development of backfill material for a nuclear fuel waste vault", *AECL TR-350*, pp. 561–594.
- [61] Yoshinaka, R., Kazama, H., 1973, "Microstructure of Compacted Kaolin Clay", *Soils and Foundations*, Vol. 13, pp. 19-34.