



Finding A fragment of Nebneteru's Offering Table from The Third Intermediate Period

Hussien Abdo Khalifa

Egyptology - Faculty of Archaeology -
South Valley University - Egypt.

abdo.hussien@gmail.com

hussien.abdo@arch.svu.edu.eg

ABSTRACT

This research studies and analyses an unpublished fragment of limestone offering table, which belonged to a donation by Zaki Mohareb and stored in the Abu-Elgood Museum's storage in Luxor, listed in a special register (Zaki Mohareb No. 2) under inventory no. (2571). No information is available regarding its archaeological context, origin, or owner in the museum's storage records.

The offering table belonged to "Nebneteru," a high-ranking individual who held the title of "Overseer of Craftsmen and Sculptors of the Lord of the Two Lands". The table is adorned with hieroglyphic inscriptions, including the *hṯp di nsw.t* formula addressed to the goddess Mut, to Amun-Ra and Mut, and possibly Amun-Ra, where only the first letter of Amon's name is preserved. The text is followed by the titles and name of the owner, likely dating to the Third Intermediate Period.

This paper aims to provide a complete publication of this fragmentary offering table, including a facsimile of the inscriptions, a translation, and an in-depth analysis of the textual content. The study attempts to reconstruct the original form of the fragment and classify it among the known categories of offering tables in ancient Egypt. The study explores the name Nebneteru's occurrences to determine a precise dating and original location of the offering table.

ARTICLE INFO

Article history

Received 6 February 2024

Received in revised form 14 August 2024

Accepted 1 January 2025

Available Online 1 February 2025

KEYWORDS

Nebneteru- Offering table- Overseer of the craftsmen and the Sculptors of the Lord of the Two Lands- Third Intermediate Period.

INTRODUCTION

Offerings to the dead have been performed since prehistoric times, and this tradition endured for millennia. In predynastic times, bread was placed on a mat in front of the grave as an offering (Boloshakov, 2001, p. 573). Throughout ancient Egyptian history, offering tables became essential components of funerary practices. They served as a connection between the living and the dead realm, providing nourishment to the deceased. These tables were commonly found in tombs, particularly near false doors or statues representing elite figures. Additionally, offering tables were often placed inside burial chambers (Hanafy, 2015, p. 1) where they gave life and force to the dead, or in temples and homes where they functioned as channels of communication between the divine realm and the deceased ancestors (Lundius E. , 2020, p. 83). Karnak Temple still preserves some of these offering tables, which are massive blocks of alabaster or granite weighing nearly eight thousand kilograms. These tables, originally used for ritualistic purposes, serve as a testament to the temple's historical and religious significance (Rady, December 2021, p. 154). It is possible that the offering table of Nebneteru was located within the Karnak Temple, as suggested by the inscriptions mentioning deities like Amun-Ra and Mut, both prominently worshipped in Karnak.

Offering tables may be dedicated to just a single person, as in the case of the present table dedicated by the individual "Nebneteru", or to two people, typically from the same family, or in certain cases, to multiple family members. Furthermore, in certain cases, a single person may possess multiple offering tables (Rady, December 2021, p. 154). Their size, shape, material, and placement reflected the social status of their owners (Lundius E. , 2020, p. 78).

The fragment of the offering table under study was part of a collection of artifacts that Zaki Mohareb donated to the Ministry of Antiquities after Law No. 117 of 1983 was passed. It was held in the Abu Elgood Museum's second storehouse in Luxor, where it was given the inventory number (2571), listed in a special register (Zaki Mohareb No. 2). Eventually, this fragment left its provenance and was likely bought or obtained in another way by Zaki Mohareb.

Unfortunately, no records exist that describe the events surrounding its discovery, because the offering table was not discovered during official excavations or archaeological surveys. Consequently, it is highly challenging to understand its origin and historical background in the absence of clear archaeological context.

The offering table of "Nebneteru" is regarded as a rare and exceptional artifact. Indeed Mariette noted that the use of offering tables gradually declined after the New Kingdom, becoming extremely rare during the Ptolemaic and Roman periods (Mariette A. , Notice Des Principaux Monuments Exposés Dans Les Galeries Provisoires Du Musée D'antiquités Égyptiennes De S. A. Le Vice-Roi A Boulaq, 1864, p. 30). Since this offering table dates to the Third Intermediate Period, it stands as significant archaeological artefact to historical knowledge regarding.

Offering table no. 2571 belonged to Nebneteru who was the Overseer of Craftsmen and Sculptors of the Lord of the Two Lands during the Third Intermediate Period. The available information about Nebneteru is extremely limited, and Kamal does not mention his name or his title in his book on offering tables (Kamal, 1909, pp. 175-192); (Kamal, 1909, pp. 193-196).

DESCRIPTION:

Unfortunately, the offering table under study is missing part of its shape, which has made its classification somewhat challenging. therefore, we present the typical styles of offering tables in ancient Egypt based on their shapes to identify the category to which this offering table belongs (Hölzl, 2002, p. 11):

Type	Description
Type φ	pedestals, tables and offering tables that do not have any main characteristics.
Type A	Offering tables with round elevations and/or depressions or isolated round offering tables.
Type B	Offering tables with basins or isolated cult basins.
Type C	Offering tables with bread loaves or the <i>htp</i> sign, or offering tables in the shape of the <i>htp</i> sign.
Type A+B	Offering tables with round elevations and/or depressions and basins.
Type A+C	Offering tables with round elevations and/or depressions and bread loaves or the <i>htp</i> sign.
Type B+C	Offering tables with basins and bread loaves or the <i>htp</i> sign.
Type A+B+C	Offering tables with round elevations and/or depressions, basins, and bread loaves or the <i>htp</i> sign.

Since the offering table is incomplete and its left side is missing, we attempt to reconstruct its original complete shape based on the typical shapes of offering tables in ancient Egypt. It is likely that the lower part of the offering table was inscribed with the shape of the *htp* sign, which is in the form of a bundle of mat, with a large portion visible (Figs. 1-2). On the right side above the *htp* sign, two basins can be clearly seen, making it likely that the missing left

side bore the same (Figs. 3-5). The left side may also have been depicted with various offerings (Figs. 4-6). Regarding the upper part of the table, it may have been raised to resemble the shape of the *htp* sign (Figs. 3-4).



Fig.1: Offering table No. 2571(taken by M. Samah)

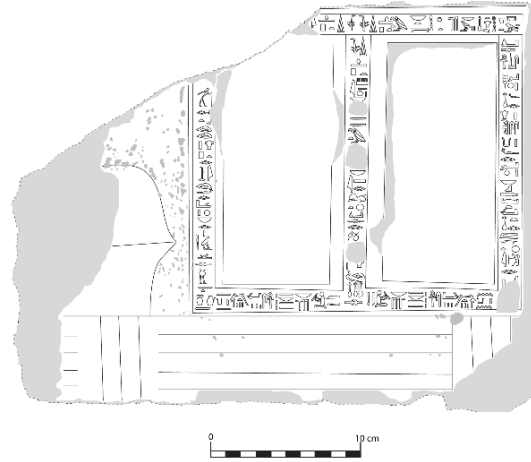

Fig. 2: Facsimile of Offering table No. 2571(Line Drawing by Author)

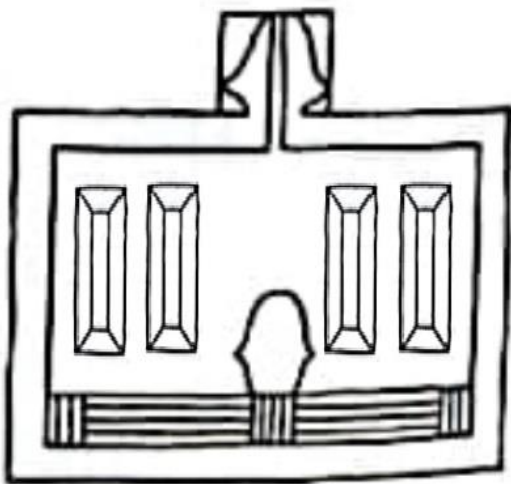

Fig.3 Reconstitution a of the Shape, (Design by Author)

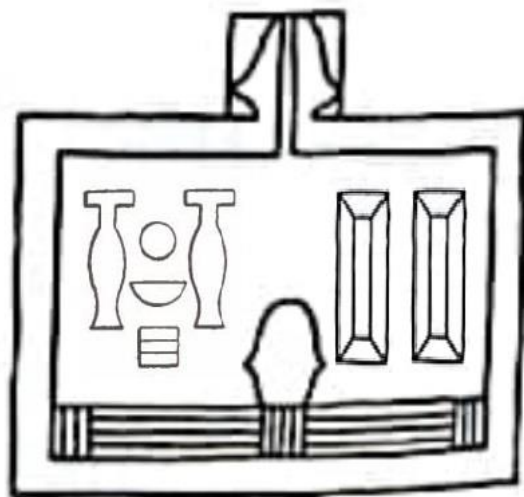

Fig.4 Reconstitution a of the Shape, (Design by Author)

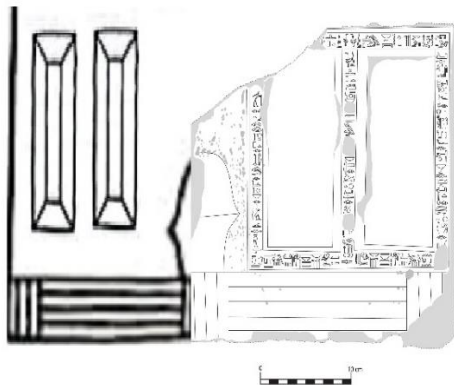

Fig. 5 Potential reconstruction a of the offering table

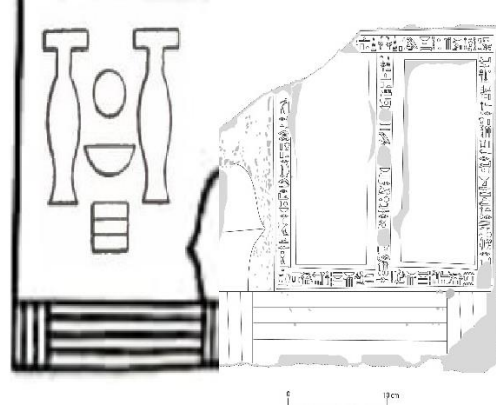





Fig. 6 Potential reconstruction a of the offering table

Therefore, this offering table could be classified, as belonging to type B+C. 'Opfertafeln mit Becken oder isolierte Kultbecken' (Hözl, 2002, pp. 11, 15, 24), (Lundius E. , 2020, p. 87). This type of offering tables is notable for its distinctive characteristics; In addition to the sign *htp*  it has one to six embedded basins; the most common is the offering table with two basins, which are arranged to the right and left of the sign *htp*  (Hözl, 2002, p. 15). Generally, these basins are made on the offering tables to provide the deceased's soul with water. They are an important source of water supply, which is essential to the deceased's life in eternal life (Abdelrahman, 2022, pp. 99-100).

The Fragment of Nebneteru's Offering Table:

This fragment of the offering table No.2571 is rectangular and divided into two sections. The preserved portion is the right part of the offering table, which is made of limestone. It measures 31 cm in length, 24 cm in width, and 10 cm in thickness. The inscriptions are carved in sunken relief. The left corner of the right part is missing, and some hieroglyphic signs show traces of wear, making them challenging to read. The fragment is in a medium state of preservation. At the Centre of this square fragment, two rectangular basins intended for offerings are present. The fragment of the offering table lacks decorations or colours, except for three lines of hieroglyphic signs. Two lines run along the edges of the basins; the signs reversed their orientation around at a certain point without changing their reading order, while a vertical column is positioned in the middle. At the base, a partially visible portion of the sign *htp* () can be observed. This sign imitates the offering practice of Predynastic times, when bread was placed on a mat spread in front of the grave. The hieroglyph *htp* () , which means 'offering,' derives from the root 'to be satiated' or 'to be peaceful, reflecting its historical and symbolic significance (Boloshakov, 2001, p. 573).

TEXTS:

The text on this fragment of the offering table consists of a hieroglyphic inscription framed by two thin sunken lines that define its boundaries. The hieroglyphic signs themselves are roughly etched, and their interpretation can be challenging in certain areas due to stone deterioration. The framing lines consist of one on the right and another on the left of the hieroglyphic text, encompassing two basins and a single column of hieroglyphs located between the basins.

The framing lines start horizontally at the top, then descend vertically along each side of the table, and finally run horizontally again at the bottom, meeting on either side of the middle column. The orientation of the hieroglyphs shifts at the corners of the table, adapting to its layout.

The text starts on both the lines and the middle column with the offering formula *htp di nsw.t* (Lapp, 1984, pp. 430-434), (Barta W. , Aufbau und Bedeutung der altägyptischen offerformel, 1968, pp. 263-295), (Gardiner A. H., 1915, pp. 79-93), (Satzinger, 1977, pp. 177-188), (Franke D. , 2003, pp. 39-57). This formula is addressed to Mut on the right line, to Amun-Ra and Mut on the middle column, and possibly Amun-Ra on the left line, where only the first sign of Amun's name is preserved.

The owner's name and title are inscribed at the end of the left and right lines using the hieroglyphic signs.

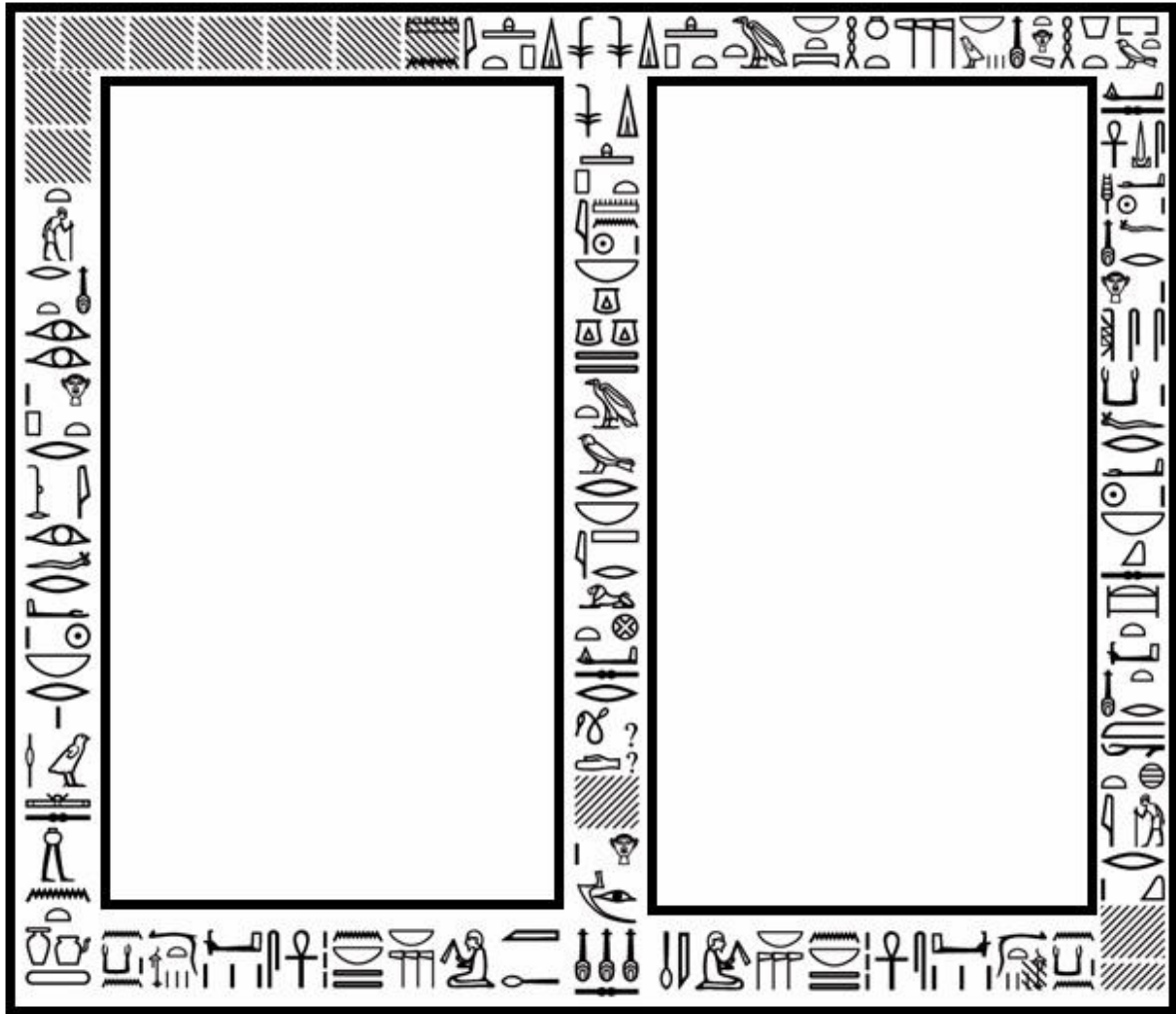

Right line



ḥtp-di-nsw.t (n) Mwt nb.t pt ḥnw.t nṯr.w nb.w nfr.t ḥr ḥnw.t pr-wr.

An offering which the king gives (to) Mut mistress of heaven, lady of the whole gods, whose face is perfect, lady of the *per-wer* (be satisfied).



di =s ḥnh wd3 snb ḥw nfr ḥr šms[s] k3=f (sic) rḥ nb krs.t nfr.t m-ḥt i3w r [... ...].

(So That) she grants life, prosperity, health, a good lifetime following his (sic) *ka* every day, a good burial after an old age [... ...]





n k3 n(y) imy-r(3) ḥmw.w sḥnh.w n(y) nb t3.wy nb-nṯr.w m3ḥ-hrw.

For the *ka* of the Overseer of the Craftsmen and the Sculptors of the Lord of the Two-Lands, Nebneteru true of voice.



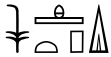









Comment

- The offering formula *ḥtp di nsw.t* was written in different forms during the Middle and New Kingdoms. Two common variations of this formula have been identified: the first

form  was attested from the 12th to the 13th Dynasty, while the second form

 appeared at the beginning of the 14th Dynasty and continued thereafter (Smither, 1939, p. 34); (Franke D. , 2003, pp. 39-57); (Leprohon, 1990, pp. 163-164). The offering formula *htp di nsw.t*, traditionally translated as “an offering which the king gives to” an individual', reflects a significant aspect of the Egyptian offering system. This interpretation aligns with the concept of the “reversion of offerings” a unique practice in which offerings were initially presented by the donor to the gods and subsequently returned by the gods to the donor or the deceased (Rady, December 2021, p. 155); (Mauss, 1923-1924, pp. 30-186.).

- In the offering formula *htp-di-nsw.t* addressed to the goddess Mut, the dative preposition (*n*) before the deity's name is attested from as early as the 9th Dynasty and can be observed in inscriptions up to the Graeco-Roman Period. However, variations in the use of this preposition are noted depending on regional and temporal factors, as well as the stylistic preferences of scribe (Barta W. , Aufbau und Bedeutung der altägyptischen offerformel, 1968, p. 265f).
- The offering formula *htp-di-nsw.t (n) Mwt* depicts the goddess Mut (Leitz C. , Lexikon der Ägyptischen Götter und Götterbezeichnungen, Vol III, 2002, p. 251) as the sole giver of the boon in this context. Mut, as the companion of the god Amun, held a prominent position in the Egyptian religion, especially from the time of Queen Hatshepsut (Velde, 1982, p. 246). She was revered as the “Mistress of Heaven” the “Lady of All Gods” whose face embodies perfection, and the “Lady of the *Per-Wer*”.
- The goddess Mut, whose name means 'Mother,' was a prominent deity in the New Kingdom and served as the primary feminine counterpart of Amun-Ra, the king of gods. She was venerated as the great 'world-mother,' embodying maternal and protective aspects (Budge, 1904, p. 28).
- The title (*Mwt nb.t pt*), translated as “Mistress of Heaven” is attested since the Middle Kingdom as an epithet for many goddesses and deified queens (ERMAN, 1926-1950, pp. Vol I, 491). Who was depicted as a goddess with a human head, unlike many other Egyptian deities (Leitz C. , Lexikon der Ägyptischen Götter und Götterbezeichnungen, Vol IV, 2002, p. 49).
- The title (*nfr.t hr*), translated as “the one with a perfect face” is attested since the New Kingdom as an epithet of the goddess Mut and other goddesses (Leitz C. , Lexikon der Ägyptischen Götter und Götterbezeichnungen, Vol IV, 2002, p. 230).
- The title (*hnw.t pr-wr*), translated as “Lady of the *Per-Wer*” is one of the titles of the goddess Mut. The term '*Per-Wer*' refers to the palace of the Upper Egyptian located in El Kab, as well as to a room in temples that housed the Holy of Holies (ERMAN, 1926-1950, pp. Vol I, 517).
- *di =s ᵑnh wḏ3 snb* In this offering, the deceased requests life, prosperity, and health from the goddess Mut (Edel, 1977, pp. 59-62)
- The beautiful burial  (ERMAN, 1926-1950, pp. V, 65) is the desired outcome for every deceased person (Ibrahim Abd El-Sattar, 2021, p. 50).

- The scribe showed some confusion in writing some words, possibly due to the poor craftsmanship or a lack of experience; In the word  the scribe wrote the letter (p)  before the letter (t) .
- The scribe also made a mistake when writing the word ; he should have used the stroke | instead of the determinative  sign (N21).
- The scribe made a mistake when writing ; he should have used the suffix pronoun (s)  instead of the suffix pronoun (f) .
- When writing the word , he should have written the letter (r)  before the letter (t) .
- The scribe was confused when writing the word ; he should have written the stroke | after the sign (k3) .

Left line



h̄tp-di-nsw.t (n) T[mn]

An offering which the king gives (to) A[mun] (be satisfied).

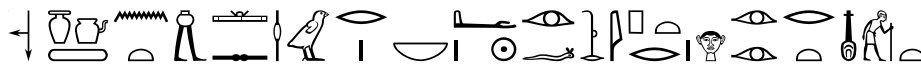

[di=f] i3w nfr ir.ty (=i) hr ptri=f r^c-nb r(3) wḏ sin=t(w) kbh (?)





[(So That) he grants] a perfect old age, (my) eyes seeing him every day, and saying command to be brought libation (?)



n k3 n(y) imy-r(3) h̄mw.w s^c-nh.w n(y) nb t3.wy nb-ntr.w m3^c-hrw.

For the *ka* of the Overseer of the Craftsmen and the Sculptors of the Lord of the Two-Lands, Nebneteru true of voice.

Comment

- The inscriptions referring to the name and titles of the god Amun-Ra are missing, and only the first letter of the name of the god Amun (*T*)  appears. However, since the god's name and titles are typically inscribed in the central column, it is most likely that the name refers to Amun-Ra.
- The offering formula *h̄tp di nsw.t (n)* Amun-Ra depicts Amun-Ra as the giver of the boon in this formula.
- The scribe was confused when writing the verb (*ptri*) ; he should have written the letter (p)  before the letter (t) .

area, west of Thebes. This inscription dates to the reign of Osorkon III, during the Third Intermediate Period (Moss P. a., *Topographical Bibliography of Ancient Egyptian Hieroglyphic Texts, Reliefs, and Paintings*, Vol.I, 1964, p. 682); (Jansen-Winkel K. , *Ägyptische Biographien der Dritten Zwischenzeit*, 1996, pp. 168, Taf. 41-43).

By retracing this name through ancient Egyptian texts, its first appearance was on an ostracona discovered in the tomb of Senenmut (TT 71), dated to the reign of King Thutmose III of the 18th Dynasty (Hayes W. C., 1942 (reprint 1973), pp. 24, pl. 18; O 88). while its last occurrence was documented during the reign of Osorkon III of the 23rd Dynasty during the Third Intermediate Period (Moss P. a., *Topographical Bibliography of Ancient Egyptian Hieroglyphic Texts, Reliefs, and Paintings*, Vol.I, 1964, p. 682); (Jansen-Winkel K. , *Ägyptische Biographien der Dritten Zwischenzeit*, 1996, pp. 168, Taf. 41-43).

The Nebneteru family, which existed during the 22nd and 23rd Dynasties, is considered one of the most prominent families in Thebes at the time, with numerous cross-connections to the other major Theban families. They are best known for their numerous statues, mostly from the " Cachette of Karnak ". The central figures of this family are *Hr IX*, who held the position of royal secretary, and his son and successor, *nb-ntrw IV* (Jansen-Winkel K. , *Zwei Kanopensäetze aus der Nebneteru-Familie mit ungewöhnlichen Texten*, 2019, p. 113).

The Titles of Nebneteru:

Nebneteru held two titles, both inscribed before his name:

1- *imy-r hmw.w*: this title is translated as “Overseer of craftsmen” (Jones D. , 2000, pp. 179, No. 680), (Ward W. A., 1982, pp. 38, No. 282.), (ERMAN, 1926-1950, pp. III, 85.), “The head of the craftsmen” (ERMAN, 1926-1950, pp. Vol III, 85, 11-13), “Master of craftsmen” (Al-Ayedi, 2006, pp. 91, No.295). It has also been attested in Murray (Murray M. A., 1908, p. XXII). This title first appeared in the Old Kingdom (*Altägyptisches Wörterbuch*, 2023); (Leipzig, 2023), attested in the Middle Kingdom (Couyat, 1912, pp. 46, No. 40), and the New Kingdom , and later periods.

2- *imy-r s^cnh.w*: this title is translated as “Overseer of sculptors” (Al-Ayedi, 2006, pp. 112, No. 368). It is a title that is less frequently, attested only once in the tomb of Huyu, at el-Amarna (Davies N. d., *The Rock Tombs of El Amarna*, Vol III, 1905, pp. 3-4); (Moss B. P., 1934, pp. 211-212). The title "*s^cnh n nb t3wy*", (*Thesaurus Linguae Aegyptiae*) ((BBAW), 2014), translates to “Sculptor of the Lord of the two Lands”. This title is an epithet of professional designation in ancient Egyptian society. The term “Lord of the Two Lands” refers to the king, who ruled over both Upper and Lower Egypt.

A “Sculptor of the Lord of the Two Lands” would have been an artist responsible for creating statues, reliefs, and other artistic works commissioned by or dedicated to the pharaoh.

This position held great significance, as art played a vital role in ancient Egyptian culture, serving religious, political, and ceremonial purposes. Holding such a title indicated exceptional skill and conferred a prestigious status within the artistic community of that time (Humanities B.-B. A., 2024).

During the Third Intermediate period, titles such as “Overseer of Craftsmen” (*imy-r(3) hmw.w*) and “Overseer of Sculptors” (*imy-r s^cnh.w*) were granted to individuals of high status who supervised the work of craftsmen and sculptors within the kingdom.

These titles reflect Nebneteru’s high status and significant responsibilities within the Theban region during the Third Intermediate Period. They underscore the importance of craftsmen and sculptors in ancient Egyptian religious and administrative systems, particularly within the context of monumental construction and temple decoration. These titles are written

in an abbreviated format: *imy r(3) hmw.w s^cn^hw n(y) nb t3wy*, which translated to “Overseer of the craftsmen and the sculptors of the Lord of Two Lands”. There is another possibility that these two titles could actually be a single title, as there is no clear evidence of the omission of the word "*imy-r3*".

Significance of the Titles and its Functions:

1- Supervision of Artistic and Architectural Production:

Holders of such titles were responsible for organising and directing the work of craftsmen and sculptors, ensuring the quality and accuracy of artistic and architectural outputs

2- Coordination Between Craftsmen and Royal Administration:

These overseers acted as intermediaries between craftsmen and royal administration, ensuring that projects were executed in alignment with royal and religious requirements

3- Preservation of Artistic Standards:



They played a crucial role in maintaining artistic and technical standards, ensuring the continuity of craft traditions across generations (Jones D. , 2000, pp. 179, No. 680); (Ward W. A., 1982, pp. 38, No. 282); (Al-Ayedi, 2006, pp. 91, No. 295).





DATE AND PROVENANCE OF THE OFFERING TABLE NO. 2571:



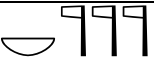

The special register of Zaki Mohareb No.2 at the Abu-Elgood Storeroom Museum at Luxor lacks information regarding the provenance and date of the offering table no. 2571. Indeed, it was part of a collection of artefacts donated to the ministry of Antiquities by Zaki Mohareb.

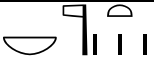
A definite date for this offering table cannot be specified due to the lack of information mention of the owner's family, furthermore; there is insufficient information in the titles contained in the inscriptions to establish a definitive connection between the offering table and any other monument.

However, all ancient Egyptian texts that mention the name "Nebneteru" have been analysed. Through the linguistic study of this name, it became clear that it was written in various forms in terms of its orthography:

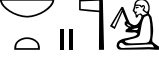
No.	Form of the Name	Transliteration	Period	Location Found	Additional Notes
1		<i>nb ntrw</i>	Rameses II (19 th Dynasty)	Thebes-West	This orthography is mentioned only once (Ostrakon in Deir el-Medineh) (Posener G. , 1951-1952, p. 18) ; (Barta W. , Das Schulbuch Kemit, 1978, pp. 6-14)during the reign of Rameses II (Moss P. a., Topographical Bibliography of Ancient Egyptian Hieroglyphic Texts, Reliefs, and Paintings, Vol.I, 1964, p. 219)
2		<i>nb ntrw</i>	Osorkon II (22 nd Dynasty)	Karnak Thebes-West	In total, this orthography is mentioned six times: twice at Karnak (Cachette of Karnak)

					(Legrain, 1914, pp. 58-62); (Otto, 1954, pp. 136-139) and four times in Western Thebes on (four canopic jars) (Jansen-Winkeln K. , Zwei Kanopensätze aus der Nebneteru-Familie mit ungewöhnlichen Texten, 2019, pp. 113-122) dating to the reign of Osorkon II
3		<i>nb ntrw</i>	Padibastet I (23 rd Dynasty)	Karnak	This orthography is mentioned only once (Cachette of Karnak) (Jansen-Winkeln K. , Ägyptische Biographien der Dritten Zwischenzeit, 1996, pp. 150-155); (Legrain, 1914, pp. 56-67)during the reign of Padibastet I
4		<i>nb ntrw</i>	Osorkon III (23 rd Dynasty)	Thebes-West	This orthography is mentioned twice (Tomb of Nebneteru in the Ramesseum necropolis (Moss P. a., Topographical Bibliography of Ancient Egyptian Hieroglyphic Texts, Reliefs, and Paintings, Vol.I, 1964, p. 682)) during the reign of Osorkon III
5		<i>nb ntrw</i>	Osorkon III (23 rd Dynasty)	Thebes-West	This orthography is mentioned only once (Tomb of Nebneteru in the Ramesseum necropolis (Moss P. a., Topographical Bibliography of Ancient Egyptian Hieroglyphic Texts, Reliefs, and Paintings, Vol.I, 1964, p. 682)) during the reign of Osorkon III; It is the same orthography as on the offering table under study
6		<i>nb ntrw</i>	Osorkon II (22 nd Dynasty)	Karnak	This orthography is mentioned only once (Cachette of Karnak) (Legrain, 1914, pp. 58-62); (Otto, 1954, pp. 136-139) during the reign of Osorkon II
7		<i>nb ntrw</i>	Padibastet I (23 rd Dynasty)	Karnak	This orthography is mentioned only once (Cachette of Karnak) (Legrain, 1914, pp. 62-65, Pl. 33); (Jansen-Winkeln K. , Ägyptische Biographien der Dritten Zwischenzeit, 1996, pp. 136-149)during the reign of Padibastet I

8		<i>nb ntrw</i>	Padibastet I (23 rd Dynasty)	Karnak	This orthography is mentioned only once (Cachette of Karnak) (Legrain, 1914, pp. 62-65, Pl. 33) during the reign of Padibastet I
9		<i>nb ntrw</i>	Padibastet I (23 rd Dynasty)	Karnak	This orthography is mentioned only once (Cachette of Karnak) (Legrain, 1914, pp. 62-65, Pl. 33) during the reign of Padibastet I
10		<i>nb ntrw</i>	Osorkon II (22 nd Dynasty)	Karnak	This orthography is mentioned only once (Cachette of Karnak) (Legrain, 1914, pp. 58-62) during the reign of Osorkon II
11		<i>nb ntrw</i>	Osorkon II (22 nd Dynasty)	Karnak	This orthography is mentioned four times (Cachette of Karnak) (Legrain, 1914, pp. 58-62) during the reign of Osorkon II

By analysing the orthography of the name “Nebneteru” it becomes evident that the spelling and hieroglyphic signs on the offering table under study “” correspond specifically to the one identified during the reigns of King Osorkon III (23rd Dynasty) during the Third Intermediate Period. Therefore, the inscription of the name “Nebneteru”, and thus the offering table no. 2571, can be confidently attributed to the same historical timeframe, the Third Intermediate Period, specifically the 23rd Dynasty.







































































The name “Nebneteru” appeared in all its orthographic variations a total of 21 times. Its first mentioned instance was on an ostrakon from the reign of Thutmose III, while its last occurrence was documented during the reign of Osorkon III. However, 19 out of these 21 instances were documented during the Third Intermediate Period, strongly indicating that the owner of the offering table lived during this era.















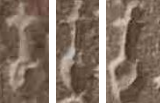











The owner of the offering table "Nebneteru", probably lived in the Theban region, as evidence supports this conclusion:

- 1- All inscriptions bearing the name Nebneteru were discovered in Luxor, either in the Karnak Cachette or in western Thebes.
- 2- The two deities invoked in the offering formula, Mut and Amun-Ra, were the principal gods worshipped in Thebes.
- 3- The title of the goddess Mut, "*nb.t išrw*" “Mistress of the Isheru-Lake”, refers to the sacred lake located within the Karnak Temple complex.
- 4- The name “Nebneteru” was frequently mentioned in association with the Temple of Amun in Karnak during the Third Intermediate Period.
- 5- A prominent family, to which several individuals named "Nebneteru" belonged, resided in Thebes during the 22nd and 23rd Dynasties.





PALAEOGRAPHIC COMMENT:















The inscriptions exhibit interesting graphic peculiarities, with the scribe using some hieroglyphs in various and unusual forms.

No.	sign	Left line	Middle column	Right line
1				
2				
3				
4		----		
5		 	 	    
6		 		----
7		  	 	   
8		    	  	       
9			 	
10			----	   
11			----	

				
12				
13			-----	
14				
15			-----	
16			-----	
17				
18				

Different forms of the signs on the offering table of Nebneteru

- The sign (M23)  was inscribed in various forms and unusual ways. The inscriptions are roughly etched, and at times, the scribe inscribed it obliquely, as seen in the right line.
- The sign (R4)  was inscribed in various forms, exhibiting interesting graphic peculiarities. The upper part of the sign appears in a round shape in the right line, in a triangular shape in the left line, and in its usual form in the middle.
- The sign (V30)  was sometimes inscribed crudely and obliquely due to the poor craftsmanship of the scribe.
- The sign (D4)  was sometimes inscribed crudely and obliquely due to the poor craftsmanship of the scribe.
- The sign (D21)  was sometimes inscribed crudely and obliquely due to the poor craftsmanship of the scribe.

- For (M17)  in the right line, the scribe used the sign (H6)  instead of (M17) . Additionally, it was inscribed in various forms through the text, exhibiting interesting graphic peculiarities.
- The sign (S29)  was inscribed crudely, and its orientation was changed at the bottom of the right line.
- The sign (D35)  was inscribed crudely and in various forms throughout the text, as is evident in the right line.
- The sign (F35)  was inscribed crudely and in various forms throughout the text, sometimes obliquely, due to the poor craftsmanship of the scribe. This is evident in the right line, whereas it was inscribed in cursive in the middle column .
- The signs (R8)  were inscribed crudely, in various forms throughout the text, in cursive, and with different orientations.
- The sign (O34)  was sometimes inscribed crudely and obliquely, due to the poor craftsmanship of the scribe .
- The sign (D40)  was inscribed in various forms, exhibiting interesting graphic peculiarities.
- The sign (I9)  was inscribed in various forms throughout the text due to a lack of space.
- The sign (N35)  was inscribed in a concise (straight line), with the water wave omitted in its hieratic form, which is characteristic of the Late Period (Abdelrahman, 2022, p. 94). However, the water wave appears slightly on the lower corner of the right line in the letter *n* .
- The signs (N16)  were sometimes inscribed crudely and obliquely, due to the poor craftsmanship of the scribe.

CONCLUSION

The offering table no. 2571 belonged to the individual Nebneteru, who held the titles of Overseer of craftsmen and sculptors of the Lord of the Two Lands. However, this artefact lacks a clear archaeological context as it was donated by Zaki Mohareb after Law No. 117 of 1983 was passed and stored in the Abu-Elgood Museum's storage in Luxor. Given that offering tables become rare after the New Kingdom, this example, which appeared to be dated to the Third Intermediate Period, deserves to be studied independently, especially as it was not included in

Kamal's Catalouge.

The research highlighted several significant findings. The analysis confirms that the offering table belonged to Nebneteru, a prominent figure during the Third Intermediate Period, as reflected by the important titles inscribed on it, which emphasise his high status and significant role. The study successfully dated the fragment to the Third Intermediate Period and attempted to reconstruct the original shape of the offering table, classifying it among known categories in ancient Egypt, specifically within type B+C. It also suggests a possible association between the offering table and the Karnak Temple, thanks to the mention of its deities, Amun-Ra and Mut. Furthermore, the study identifies the Theban region as the likely origin of the table. Through the translation, analysis, and interpretation of the inscriptions, the research provided new insights into the religious and social contexts of the time. Additionally, the palaeographic and linguistic analysis of the texts revealed several mistakes made by the scribe and showed various forms of certain signs.

Bibliography

- (BBAW), B.-B. A. (2014, October 31). *Thesaurus Linguae Aegyptiae*. Retrieved January 12, 2025, from <https://aaew.bbaw.de/tla/servlet/GetWcnDetails?u=guest&f=0&l=0&wn=854209&d>
- Abdelrahman, A. A. (2022). The Offering Table of Hor-khebit from Abu-Yasin (CG 23141 = GEM 11736) with extensive notes on its cartouche-shaped basin. *IWNW, Vol 1*, 87-107.
- Al-Ayedi, A. (2006). *Index of Egyptian Administrative, Religious and Military Titles of The New Kingdom*. Obelisk Publications.
- Altägyptisches Wörterbuch, w. c. (2023, Nov. 24). "*jm.j-r'-ḥmw.tjw*" (Lemma ID 550203) in: *Thesaurus Linguae Aegyptiae* . Retrieved Jan. 24, 2024, from <https://thesaurus-linguae-aegyptiae.de/lemma/550203>
- Bacs, T. A. (2015). Some Aspects of Tomb Reuse During The Twentieth Dynasty. *Joyful in Thebes Egyptological Studies in Honor of Betsy M. Bryan*, 1-9.
- Barta, W. (1968). *Aufbau und Bedeutung der altägyptischen Opferformel*. Glückstadt : J.J. Augustin.
- Barta, W. (1978). Das Schulbuch Kemit. *ZÄS 105*, 6-14.
- Boloshakov, A. O. (2001). Offering Tables. *OEA 2*, 572-576.
- Brugsch, H. (1879). *Dictionnaire Géographique de L' ancienne Égypte*. Leipzig.
- Brunner, H. (1955). Das Besänfligungslid im Sinuhe (B 269-179). *ZÄS 80*, 5-11.
- Budge, E. A. (1904). *The Gods of The Egyptians, Vol II*. London.
- Couyat, M. J. (1912). *Les Inscriptions Hiéroglyphiques et Hiératiques du Ouâdi Hammâmât*. Cairo.
- Davies, N. d. (1905). *The Rock Tombs of El Amarna, Vol III*. London: London.
- Edel, E. (1977). Die Keilschriftliche Wiedergabe von anx wDA snb in den Ramsesbriefen. *Gm 25*, 59-62.
- Erman, A., & Grapow, H. (1971). *Wörterbuch der Aegyptischen Sprache, IV*. Berlin: Akademie-Verlag.
- Franke, D. (2003). The Middle Kingdom Offering Formulas: A Challenge. *JEA 89*, 39-57.
- Gardiner, A. H. (1915). "*The meaning of the formula Htp di nsw*" in: *Davies N. de. G. & Gardiner, A. H., The Tomb of Amenemhat*. London.
- Green, L. (2001). *Coffins, Sarcophagi, and Cartonnages* (Vol. I). Oxford.
- Hanafy, D. (2015). CG 1305: an Offering Table in The Egyptian Museum With a Short Notation on Festivals. *SHEDET, Vol 2, Issue 2*, 1-11.
- Hayes, W. C. (1942 (reprint 1973)). *Ostraka and Name Stones from the Tomb of Sen-mut (No. 71) at Thebes, The Metropolitan Museum of Art, The Egyptian Expedition. Supplement to BMMA (Nr. 1410)* . New York: New York.
- Hözl, R. (2002). *Ägyptische Opfertafeln und Kultbecken: eine Form- und Funktionsanalyse für das Alte Mittlere und Neue Reich*. Hildesheim: Gerstenberg.
- Humanities, B.-B. A. (2024, November 5). *Thesaurus Linguae Aegyptiae*. Retrieved January 12, 2025, from https://thesaurus-linguae-aegyptiae.de/lemma/854209?lang=en&utm_source
- Humanities, t. U. (2023, Nov 18). *the Thesaurus Linguae Aegyptiae*. Retrieved Dec 21, 2023, from <https://thesaurus-linguae-aegyptiae.de/sentence/IBUBdyEUceZcMUrAgqvqXVHxx5c>
- Humanities, t. U. (2023, Nov 18). *Thesaurus Linguae Aegyptiae*. Retrieved Dec 21, 2023, from [https://thesaurus-linguae-aegyptiae.de/search/sentence?tokens\[0\].lemma.id=700003&page=1](https://thesaurus-linguae-aegyptiae.de/search/sentence?tokens[0].lemma.id=700003&page=1)
- Humanities, U. o. (2023, Nov 18). *Thesaurus Linguae Aegyptiae*. Retrieved Dec 21, 2023, from

- [https://thesaurus-linguae-aegyptiae.de/search/sentence?tokens\[0\].lemma.id=700003&page=2](https://thesaurus-linguae-aegyptiae.de/search/sentence?tokens[0].lemma.id=700003&page=2)
- Ibrahim Abd El-Sattar, S. S. (2021). Three Old Kingdom Fragmentary Reliefs and Their owners. *JGUA2, Vol 6,* 41-58.
- Jansen-Winkel, K. (1996). Zur Bedeutung von jmAx. *BSEG 20* , 29-36.
- Jansen-Winkel, K. (2019). Zwei Kanopensätze aus der Nebneteru-Familie mit ungewöhnlichen Texten. *GM 259*, 113-122.
- Jones, D. (2000). *An Index of Ancient Egyptian Titles, Epithets and Phrases of the old Kingdom, Vol I*. England: Publishers of British Archaeological Reports.
- Kamal, A. B. (1909). *Catalogue Général des Antiquités Égyptiennes du Musée du Caire Tables d' Offrandes*. Caire: L'Institut Français d'Archéologie Oriental.
- Lapp, G. (1984). Sarg. Särge des AR und MR. *LÄ V*, 430.
- Legrain, G. (1914). *Catalogue Général Statues et Statuettes III*. Le Caire: IFAO.
- Leipzig, T. S.-B.-W.-E. (2023, Nov 24). *Thesaurus Linguae Aegyptiae*. Retrieved Jan 24, 2024, from [https://thesaurus-linguae-aegyptiae.de/search/sentence?tokens\[0\].lemma.id=550203&page=1](https://thesaurus-linguae-aegyptiae.de/search/sentence?tokens[0].lemma.id=550203&page=1)
- Leitz, C. (2002). *Lexikon der Ägyptischen Götter und Götterbezeichnungen, Vol III*. Paris.
- Leitz, C. (2002). *Lexikon der Ägyptischen Götter und Götterbezeichnungen, Vol IV*. Paris.
- Leprohon, R. J. (1990). The Offering Formula in the First Intermediate Period. *JEA 76*, 163-164.
- Lundius, E. (2020). Offering Tables as Ritual Landscapes: An Anthropological Perspective of Ancient Egyptian Materia Magica. *Distant World Journal, Vol 4*, 78-106.
- Mariette, A. (1864). *Notice Des Principaux Monuments Exposés Dans Les Galeries Provisoires Du Musée D'antiquités Égyptiennes De S. A. Le Vice-Roi A Boulaq*. Alexandrie: Imprimerie Française Moures.
- Mauss, M. (1923-1924). Essai sur le don. Forme et raison de l'échange dans les sociétés archaïques. *L'Année sociologique* , I, 30-186.
- Moss, B. P. (1934). *Topographical Bibliography of Ancient Egyptian Hieroglyphic Texts, Reliefs, and Painting, Vol IV*. Oxford: The Clarendon Press.
- Moss, P. a. (1927- 1995). *Topographical Bibliography of Ancient Egyptian Hieroglyphic Texts, Reliefs, and Paintings, Vols I*. Oxford: The Clarendon Press.
- Moss, P. a. (1964). *Topographical Bibliography of Ancient Egyptian Hieroglyphic Texts, Reliefs, and Paintings, Vol.I*. Oxford: Griffith Institute, Ashmolean Museum.
- Mousa, A. &. (1977). *Das Grab des Nianchchnum und Chnumhotep, AV 21*. Mainz : Philipp von Zabern.
- Murray, M. A. (1908). *Index of Names and Titles of The Old Kingdom*. London.
- Otto, E. (1954). *Biographische Inschriften der Spätzeit*. Wiesbaden: Harrassowitz Verlag.
- Polz, D. (1990). Bemerkungen Zur Grabbenutzung in der Thebanischen Nekropole. *MDAIK 46*, 301-336.
- Posener, G. (1951-1952). *Catalogue des ostraca hiératiques littéraires de Deir el Médineh*. Le Caire: Institut français d'archéologie orientale.
- Rady, M. (December 2021). The Offering Table of rdi.n Ptah. *International Journal of Tourism and Hospitality Management, Vol. 4, Issue 2*, 153-178.
- Ranke, H. (1935). *Die Ägyptischen Personennamen, Band I*. Holstein.
- Satzinger, H. (1977). Beobachtung Zur Opferformel: Theorie und Praxis. *LingAeg*, 177-188.
- Smither, P. C. (1939). The Writing of Htp-di-nsw in The middle and New Kingdom. *JEA 25*, 34-37.
- Velde, H. t. (1982). Mut. *Lexikon der Ägyptologie, Vol IV*, 246-248.
- Ward, W. A. (1982). *Index of Egyptian Administrative and Religious Titles of the Middle Kingdom*. Beirut : American University of Beirut.

العثور على جزء من مائدة قرابين نب نثرو من عصر الانتقال الثالث

الملخص

يدرس هذا البحث ويحلل قطعة غير منشور من مائدة قرابين من الحجر الجيري، والتي كانت ضمن تبرع قدمه زكي محارب، ومحفوطة حالياً بالمخزن المتحف بأبي الجود في الأقصر، ومدرجة في سجل خاص (زكي محارب رقم ٢) تحت رقم الجرد (٢٥٧١). لا توجد معلومات بشأن سياقها الأثري أو مصدرها أو مالكاها في سجلات المخزن المتحفي.

تخص مائدة القرابين "نب نثرو"، وهو شخص ذو مكانة عالية حمل لقب "المشرف على الحرفيين والنحاتين لسيد الأرضين". المائدة مزخرفة بنقوش هيروغليفية تشمل صيغة القران موجهة إلى الإلهة موت، وإلى آمون-رع وموت، وربما إلى آمون-رع على السطر الأيسر، حيث لم يُحفظ سوى الحرف الأول من اسم آمون، يتبع النص الألقاب واسم المالك، ويُحتمل أن يعود إلى عصر الانتقال الثالث. تهدف هذه الورقة إلى تقديم نشر كامل لهذا الجزء من مائدة القرابين، بما في ذلك نسخ للنقوش وترجمة وتحليل دقيق للنصوص، ويسعى البحث إلى إعادة بناء الشكل الأصلي لهذا الجزء وتصنيفه ضمن الأشكال المعروفة لموائد القرابين في مصر القديمة. كما يتناول البحث جميع الإشارات إلى اسم نب نثرو، بهدف تحديد تاريخ دقيق ومكان المائدة الأصلي.

حسين عبده خليفة

قسم الآثار المصرية - كلية الآثار
جامعة جنوب الوادي

abdo.hussien@gmail.com

hussien.abdo@arch.svu.edu.eg

بيانات المقال

تاريخ المقال

تم الاستلام في ٦ فبراير ٢٠٢٤
تم استلام النسخة المنقحة في ١٤ أغسطس ٢٠٢٤

تم قبول البحث في ١ يناير ٢٠٢٥
متاح على الإنترنت في ١ فبراير ٢٠٢٥

الكلمات الدالة

نب نثرو، مائدة قرابين، المشرف على الحرفيين والنحاتين لسيد الأرضين، عصر الانتقال الثالث.