

Study of Heat Transfer in Energy Storage System Using Phase Change Material

دراسة انتقال الحرارة في نظام تخزين طاقه باستخدام ماده متغيره الطور

A. S. Soliman , Ahmed. A. Sultan *, M.G.Mousa and A. Ramzy .
Mansoura University, Mech Power Eng. Dept, Mansoura Egypt

ملخص البحث:

في هذا البحث تم عمل دراسته نظريه لخصائص انتقال الحرارة خلال مقطع على شكل حلقه اسطوانيه مملوءه بماده متغيره الطور (شمع البرافين) مسخنه بدرجة حراره ثابتة ($T= 350 \text{ K}$) من السطح الداخلي المزود بزعانف وقد تم دراسته تأثير كلا من انتقال الحرارة بالحمل على عمليه التخزين وكذلك تغيير عدد الزعانف ودرجه الحرارة التي يسخن السطح بها بواسطه برنامج الفلونت. وقد وجد ان تأثير انتقال الحرارة بالحمل لا يمكن اهماله على العموم ولكن لوحظ ان تأثيره يقل عندما تقل المسافه المحصوره بين الزعانف الحاويه للماده متغيره الطور وبزياده عدد الزعانف تقل المسافه بينهم فيقل تأثير انتقال الحرارة بالحمل وقد وجد انه بعد 12 ساعه كانت نسبه الزيادة في الطاقه المختزنه تصل الى (116.5% , 89.6% , 62.2%) وذلك مقابل عدد من الزعانف (3 , 8 , 13) زعنفه على الترتيب. وبزياده عدد الزعانف تزيد المساحه مما يزيد من انتقال الحرارة خلال الماده متغيره الطور وذلك يقلل من الزمن اللازم لتخزين كميه معينه من الحرارة. وبزياده درجه حراره سطح التسخين الى (400K , 375K) يقل زمن تخزين الطاقه الى ثلاث واربع ساعات على الترتيب مقارنة بسنه ساعات ونصف عندما يكون درجه حراره سطح التسخين (350 K) .

Abstract

The usage of phase change materials to store heat in the form of latent heat is increased, because large quantity of thermal energy is stored in smaller volumes. A cylindrical thermal storage device is composed of an inner aluminum pipe having inner/outer diameter of 20/30 mm and length of 1000 mm. The pipe passes through a cylindrical storage device have a radius of 300 mm, fill with paraffin wax. In the present work, a numerical study of the effects of convection, number of fins and heating surface temperature on the storage characteristics of annular latent heat energy storage system (LHESS) using the CFD software FLUENT6.3.26. The results show that the effect of convection cannot be neglected, but it decreases when the space between fins decreases which occurs when numbers of fins increase. The heat transfer increases as the number fins increases and found that after 12 hours the rate of energy stored increased to 116.5% and 89.6% and 89.6% for 3 fins, 8 fins and 13 fins respectively. The temperature of heating surface is not required only to be greater than the melting point of PCM (paraffin wax) When increased to ($T= 375\text{K}$, 400K) found that it reduces the storage time energy to three and four hours while it is six and a half hours in the case of heating surface temperature of ($T= 350 \text{ K}$) and increases the stored energy in the PCM to (114.4%)

Key words

CFD, phase change material, heat transfer ,LHESS

Nomenclature

C_p	Specific heat capacity ($\text{J kg}^{-1} \text{K}^{-1}$)	g	Acceleration of gravity
D	Diameter (m)	K	Thermal conductivity ($\text{W m}^{-1} \text{K}^{-1}$)
E	Total energy stored (J)	L	Latent heat of fusion (J kg^{-1})
h	Sensible enthalpy (J/kg)	\bar{s}	Source term
H	Total enthalpy (J)	T	Temperature (K)
		t	Time (s)
		\vec{V}	Velocity vector

Greek symbols

ρ	Density (kg . m-3)
λ	Liquid fraction
μ	Dynamic viscosity

Abbreviations

CFD	:Computational fluid dynamic
IC	:Internal combustion
LHESS	:Latent heat energy storage system
PCM	:Phase change material
SHSS	:Sensible heat energy storage system
TESS	:Thermal energy storage system

1. Introduction

Thermal energy storage (TES) system using phase change materials (PCM) as a storage medium offers advantages such as high heat storage capacity , small unit size and isothermal behavior during charging and discharging when compared to other sensible heat storage (SHS) systems. TES has various domestic, industrial and power generation applications and it is a useful way of decreasing costs and overall electricity demand. Better power generation and economic benefit can be achieved if some of peak load could be shifted to the off peak load period , which can be achieved by thermal storage of heat or coolness so the size of air handling unit in air conditioning systems would be smaller (Khudhair et al 2004). As a result, this technology is becoming more applicable to a wide range of heating, ventilation and air-conditioning systems (Halford et al 2007). TESS applications include passive storage in building, thermal protection of food and electronic devices, solar energy thermal storage and heating water (Sharma et al. 2009).According to (Ogoh 2010) it is obvious that any energy storage systems incorporating phase change materials comprises significantly smaller volumes when compared to other materials that store only sensible heat. In industry PCM are used in cooling of engines , thermal comfort in

vehicles, pre heating of engine (Schatz 1992; Vasiliev and Burak. 1999; Vasiliev, Burak et al. 2000; Gumus 2009). The preheating of evaporator and pressure regulator of gaseous sequential injection system was investigated by Gumus and Ugurlu (2011) In additions applications of PCM in internal combustion engines by (Boam 1986).

In these storage systems, the modes of heat transfer encountered in the melting and solidification of phase change materials (PCM) are conduction and convection. Close melting were investigated by (Bejan 1994). Melting of phase change materials in rectangular enclosures had received considerable attention. It was demonstrated numerically that free convection plays a role during the melting process in rectangular geometries (Wang et al. 1999). It was concluded that the heat transfer rate and the melting time increased and decreased respectively, as the volume fraction of nanoparticle increased, " (Lamberg et al. 2004) obtained physical validation of the numerical results produced using FEMLAB. Through a comparison of experimental data and numerical results. The studied numerical methods are enthalpy method and effective heat capacity method. Both numerical methods gave good estimations for the temperature distribution of the storage in both the melting and freezing processes. The melting process in spherical geometry of PCM was studied numerically by (Assis et al. 2007). Also , detailed parametric investigation of melting spherical shells of various diameters with a uniform temperature. Medrano et al. (2009) investigated experimentally the heat transfer process during melting (charging) and solidification (discharge) of five small heat exchangers working as latent heat thermal storage systems. The results showed that the double pipe heat exchanger with PCM embedded in a graphite matrix was the one with higher values of storage. During the

freezing process, the temperature clearly levelled out during the phase change, due to the increase in specific heat. But in the melting process, this levelling out of temperature over the phase change range could almost not be noted at all. Ogoh (2010) presented a numerical study of the effects of fins and thermal fluid velocities on the storage characteristics of a cylindrical latent heat energy storage system. The results showed that the heat transfer rate increases with the addition of fins and increases thermal fluid velocity.

The heat transfer coefficient was more important than increase of heat transfer area. (Johansson 2011) carried out an advanced heat transfer analysis for phase change thermal energy storage system by looking at the heat transfer mechanisms in a finned cylindrical PCM heat exchanger. The position of the heat exchanger affected the overall heat transfer effect, this was because the vertically placed fins inhibited the convections less as there was larger space for gravity assisted convection mechanism. Sebti et al (2011) have numerically studied heat transfer enhancement during melting in a cylindrical annulus with dispersion of Nano particle. Paraffin-based Nano fluid containing various volume fractions of Cu is applied. It is found that the suspended Nano particles give rise to thermal conductivity as compared to the pure fluid and consequently the heat transfer is enhanced.

(Reddy and Nallusamy. 2012) studied the heat transfer in PCM. The variables studied are PCM, mass flow rate, and inlet temperature of heat transfer fluid. The PCM were stored in the form of spherical capsules of 38 mm diameter made of high density poly ethylene. It was concluded that the charging time can be reduced with increasing mass flow rates of the heat transfer fluid. Stearic acid attains maximum temperature (equal to heat transfer fluid inlet temperature) faster compared to paraffin. Also, it is stated that, from economic point

of view, the stearic acid is recommended as PCM for TESS.

In this work, the heat transfer in PCM storage tank is numerically investigated using FLUENT6.3.26. The numerical results are validated through a comparison with results from literature studies. Then, the effect of convection, number of fins and heating surface temperature on the PCM in cylindrical tank is investigated.

2. Physical model

2.1 Geometry and Materials

A cylindrical thermal storage device is studied as shown in (Fig 1) it is composed of an inner aluminium pipe having inner/outer diameter of 20/30 mm and length of 1000 mm. The pipe passes through a cylindrical storage device with a radius of 300 mm, filled with paraffin wax which is used because of its high storage capacity and low melting temperature, In addition to its thermo physical properties of the used wax are presented in (Table 2.1). To increase the rate of heat transfer from the pipe surface to paraffin wax aluminium fins are added to the pipe with 5 mm thickness.

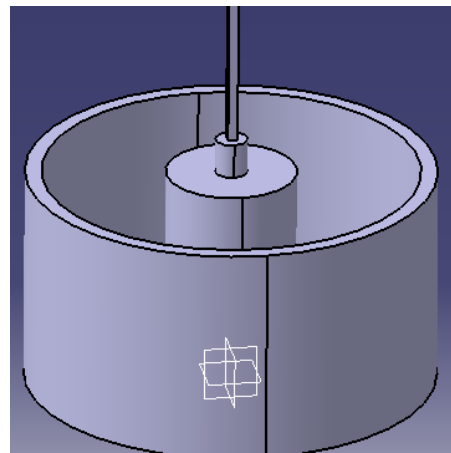

Fig (1) Geometry of thermal storage device

Table 2.1 : Thermo physical properties of Materials Groulx and Ogoh (2009).

Thermal conductivity	.21 W/m.k
Heat capacity	2.5 kJ/kg.k
Density	900 kg/m ³
Enthalpy of fusion	174 kJ/kg
Temperature range melting	313 K to 316 K

2.2 Governing Equations

In order to simulate phase change in a shell and tube heat exchanger, enthalpy method is used (Hosseini and Ranjbar. 2012). The continuity, momentum, and thermal energy equations can be expressed as follows:

Continuity:

$$\nabla \cdot \vec{V} = 0$$

Momentum:

$$\frac{\partial \vec{V}}{\partial t} + \vec{V} \cdot \nabla \vec{V} = \frac{1}{\rho} \left(-\nabla P + \mu \nabla^2 \vec{V} + \rho \beta \vec{g} (T - T_{ref}) \right) + \vec{S}$$

Thermal energy:

$$\frac{\partial h}{\partial t} + \frac{\partial H}{\partial t} + \nabla \cdot (\vec{V}h) = \nabla \cdot \left(\frac{k}{\rho C_p} \nabla h \right)$$

The enthalpy of the material is computed as the sum of the sensible enthalpy, h , and latent heat, ΔH :

$$H = h + \Delta H$$

The latent heat content can be written in terms of the latent heat of the material, L :

$$\Delta H = \lambda * L$$

Where ΔH may vary from zero (solid) to L (liquid), therefore, the liquid fraction, λ can be defined as:

$$\lambda = \begin{cases} \frac{\Delta H}{L} = 0 & \text{for } T < T_{solid} \\ \frac{\Delta H}{L} = 1 & \text{for } T > T_{liquid} \\ \frac{\Delta H}{L} = \frac{T - T_{solid}}{T_{liquid} - T_{solid}} & \text{for } T_{solid} < T < T_{liquid} \end{cases}$$

The source term \vec{S} is Darcy law damping terms (as source term) that are added to the momentum equation due to phase change effect on convection, it is defined as:

$$\vec{S} = \frac{(1 - \lambda)^2}{\lambda^3} A_{mush} \vec{V}$$

A_{mush} is a mushy zone constant; where this constant is large number, In present study is assumed constant and set to 106

2.3 Numerical solution

Numerical solution is carried out using the CFD software FLUENT6.3.26 to solve melting model and energy equation in three steps. Firstly, the geometry is created with GAMBIT software and consists of two parts. Fins and heated tube is treated as solid and spacing between fins is treated as fluid (PCM). Secondly, mesh is created by discretizing the computational domain into different mesh elements to maintain minimum skewness. The convergence criterion of 10⁻⁶ is used for the studied case. The boundary conditions are as follows the outer casing is insulated and the pipe is heated under constant wall temperature. Thirdly, the physical parameters for 2-Dimension axisymmetric model (PCM) used in this study , the specific heat capacity of paraffin wax has the following form (Salyer and Sircar .1986)

$$c_p = \begin{cases} 2.5 \frac{\text{kJ}}{\text{kg}} & \text{for } T < 313 \text{ K} \\ 60.5 \frac{\text{kJ}}{\text{kg}} & \text{for } 313 \text{ K} > T > 316 \text{ K} \\ 2.5 \frac{\text{kJ}}{\text{kg}} & \text{for } T > 316 \text{ K} \end{cases}$$

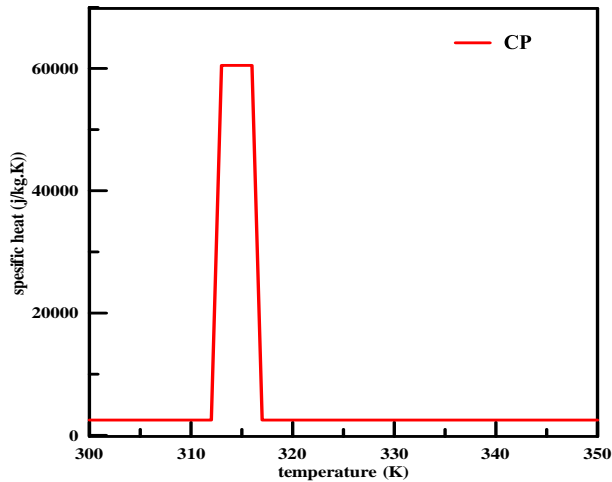

Fig (2) variation specific heat with temperature

The stored energy is in two forms sensible and latent heat. Sensible heat plays a major role in regions where the temperature of PCM is below 313 K or above 316 K and between these two temperatures the latent heat is dominated

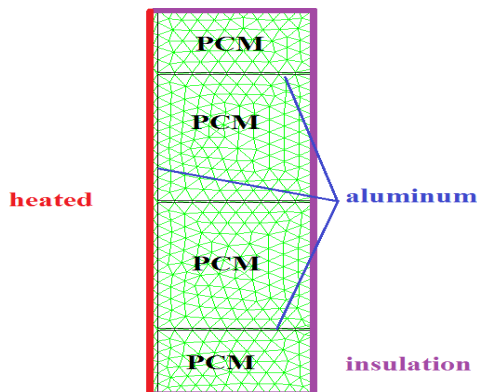

Fig (3) Numerical modeling and meshing of studied geometry (3 fins).

3. Model validation

A parametric study on mesh size was made in FLUENT6.3.26 to determine the optimum mesh size to use without losing much accuracy. The results shown in Fig (4) are for mesh sizes of (.01, .02, .03, .04, .05, .06 and .07m), it is seen from the figure that the element size below .03m did not change the PCM average temperature large.

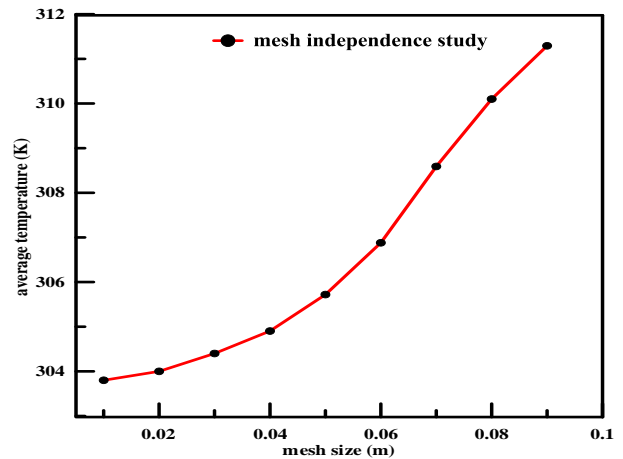

Fig (4) Parametric study on the mesh size

The PCM average temperature are compared with published results of (Groulx and Ogoh 2009). As shown in Fig (5) and Fig(6) for no fins and 3 fins respectively. It can be seen from the figures that the present result is close to the results of published one

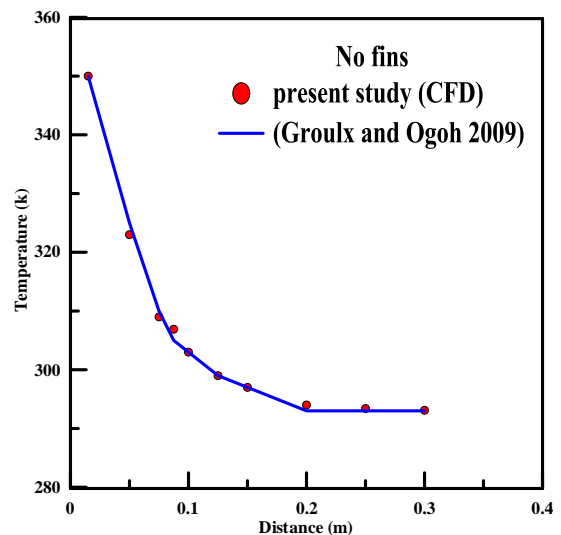

Fig (5) comparison between Groulx and case study for no fins

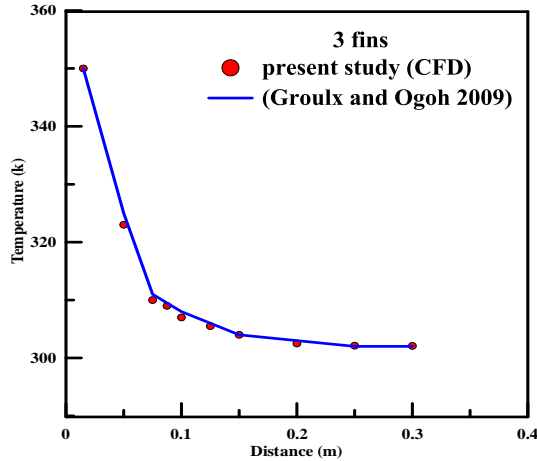

Fig (6) .comparison between Groulx and case study for (3) fins

4. Results and discussion

The present study is performed to investigate the energy storage process through a cylindrical shape PCM under constant temperature heat source. The cylindrical PCM has a height of 1m, an inside diameter of .03m and an outside diameter of .6 m. The PCM used is paraffin wax. Two models are used to solve the present problem. The first is the conduction model where the heat is assumed to transfer through the PCM by conduction only. The second is the conduction-convection model where the heat is assumed to transfer by conduction through the solid PCM and by conduction and/or convection through the melted PCM. In each model four cases are discussed including the condition of heating source with no fins. And the conditions of heating element provided with 3, 8 and 13 fins.

4.1 Conduction Model Results

Fig (7) presents the temperature contours inside the cylindrical PCM after 12 hours for conduction model with no fin and 3, 8 and 13 fins. As can be seen from this figure, the number of fins plays an important role on the overall charging and melting process. Fig (8) presents the relation between average temperature and time of charging. It is seen

from the figure that the average temperature of PCM increases with number of fins, because the fin increases the surface area and consequently increases the heat transfer to PCM.

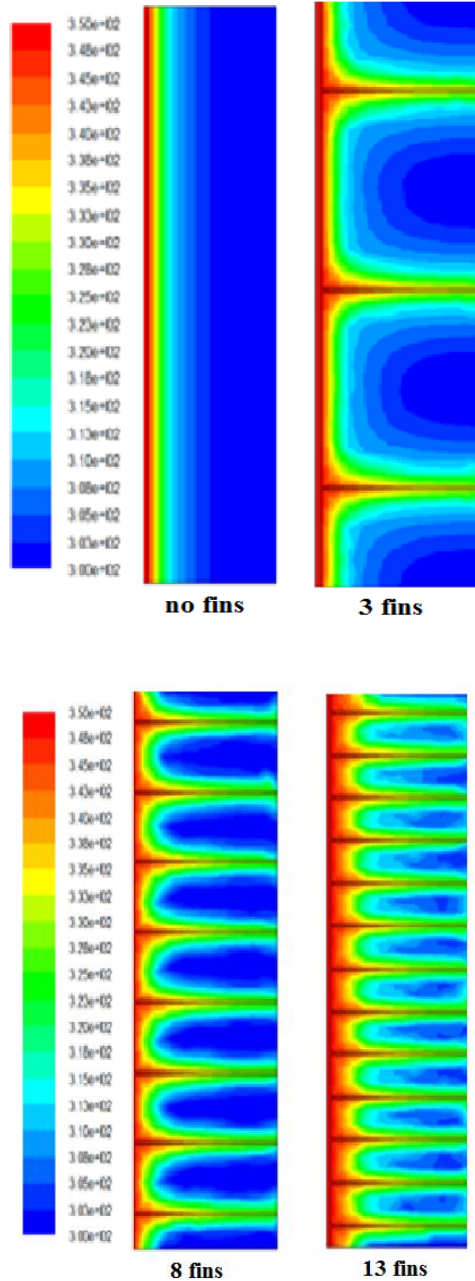

Fig (7) Temperature contours obtained after 12 hours of charging

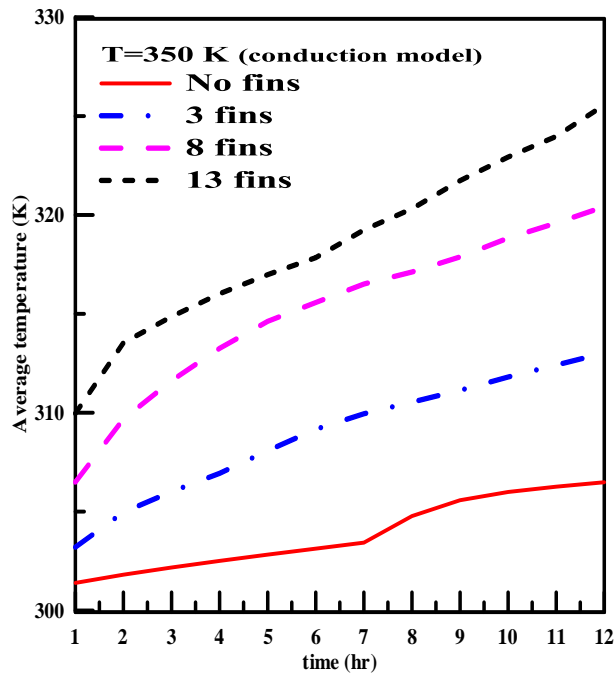

Fig (8) Average temperature for the PCM at various numbers of fins

To select the optimum case where is achieved the maximum energy stored in PCM. The liquid fraction in each case is to be calculated up to completely melting of PCM. Fig (9) Presents the liquid fraction contours inside the cylindrical PCM after 12 hours in case of no fins and (3,8,13) fins.

Fig (10) presents the relation between average liquid fraction and time. It is seen from the figure that the average liquid fraction of PCM increases with number of fins and reach a maximum value of (80%) for the case of using 13 fins..

Fig (11) presents the relation between total energy stored in PCM and time. It is seen from the figure that the total energy of PCM increases with number of fins until it reaches to a maximum value of (80%) at 13 fins.

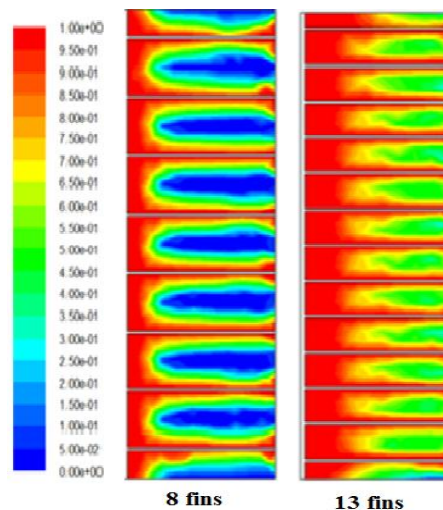
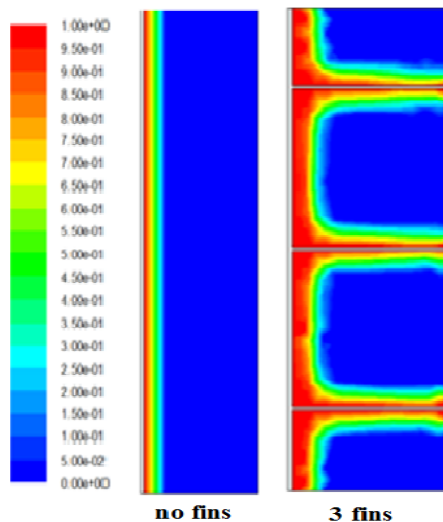

Fig (9) liquid fraction contours obtained after 12 hours of charging

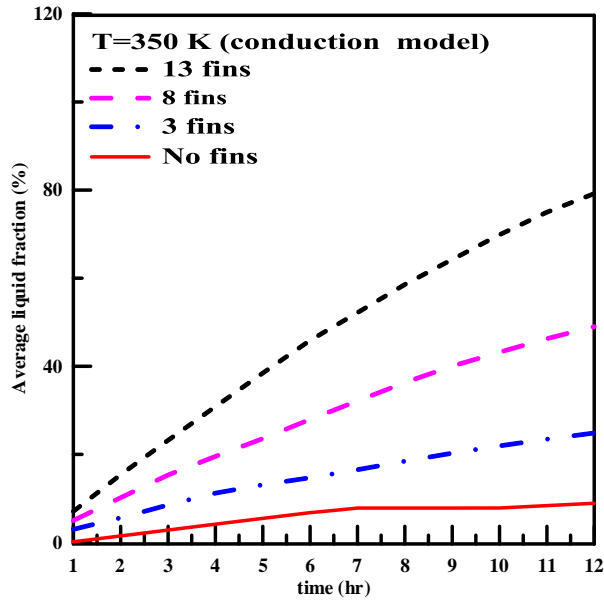

Fig (10) Transient variation of liquid fraction of PCM for various numbers of fins.

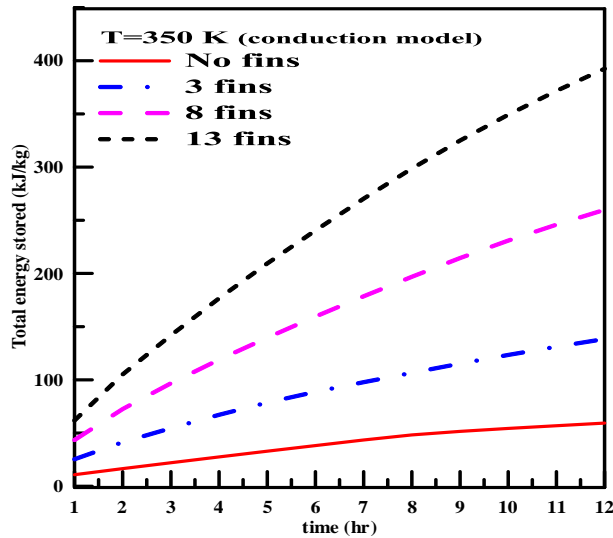

Fig. (11) Total energy stored in PCM versus time for various numbers of fins.

4.2 Conduction-Convection Model

Fig (12) presents the temperature contours inside the cylindrical PCM after 12 hours for no fins and 3, 8 and 13fins. It is shown from this figure that, the number of fins and the convection effect plays an important role in

increasing the overall melting process than conduction only.

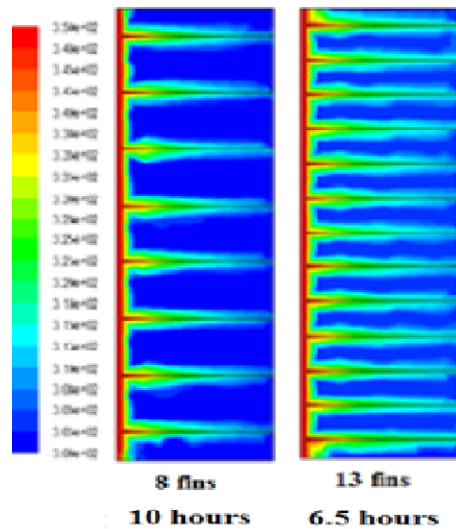
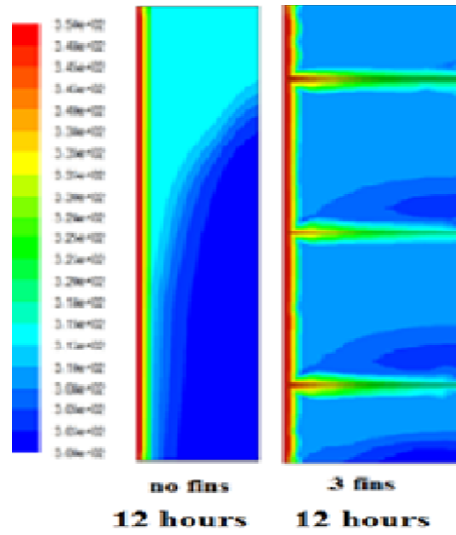

Fig. (12) Temperature contours obtained after 12 hours of charging

Fig (13) presents the relation between average temperature and time of charging. It is seen from the figure that the average temperature of PCM increases with number of fins and its values is less than that of conduction only. This is may be because most of energy is used to change the phase of PCM

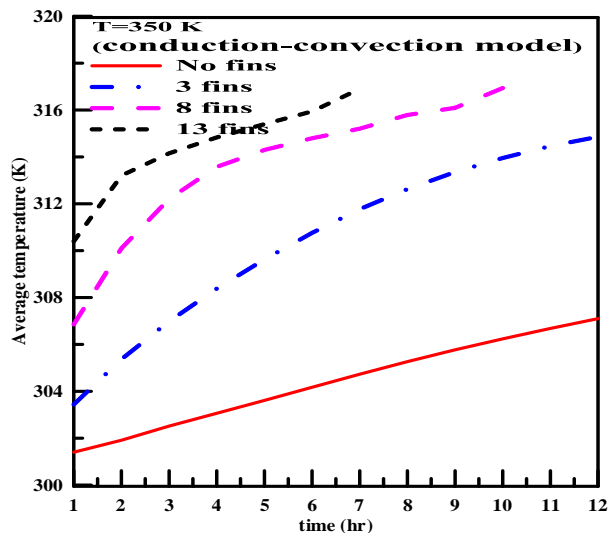

Fig (13) PCM average temperature versus time for various numbers of fins

Fig (14) presents the liquid fraction contours inside the cylindrical PCM after 12 hours for no fins and 3, 8 and 13fins

Fig (15) presents the relation between average liquid fraction and time. It is seen from the figure that the average liquid fraction of PCM increases with number of fins and reaches a maximum value of (99%) after 7 hours for the case of using 13 fins and (99.7%) after 10 hours for the 8 fins this is due to increase the heat transfer surface area.

Fig (16) presents the relation between total energy stored in PCM and time. It is seen from the figure that the total energy stored PCM increases with number of fins and reach a maximum value 415 kJ/kg after 7 hours for the 13 fins and 437 kJ/kg after 10 hours for the 8 fins case.

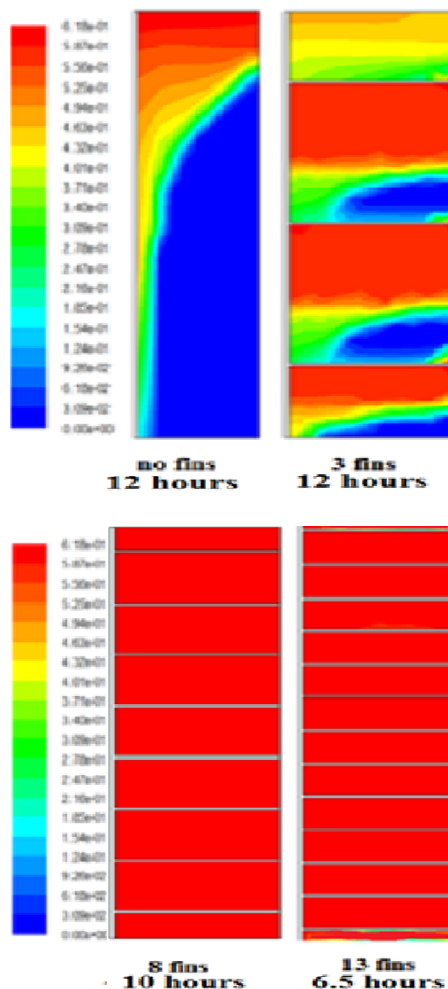

Fig (14) Liquid fraction obtained after 12 hours of charging.

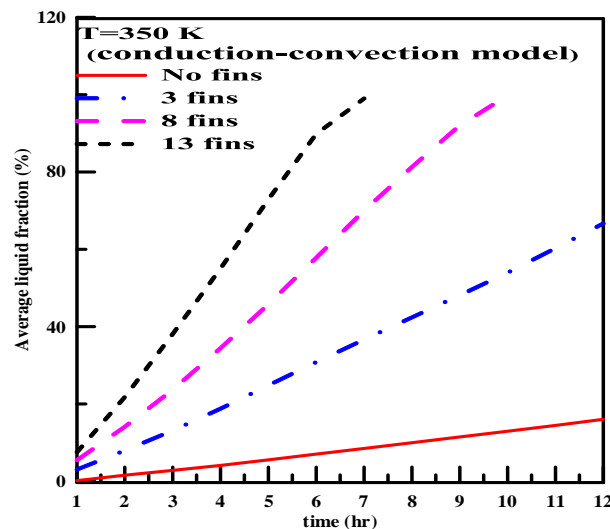

Fig (15) Transient variation of liquid fraction of PCM for various numbers of fins.

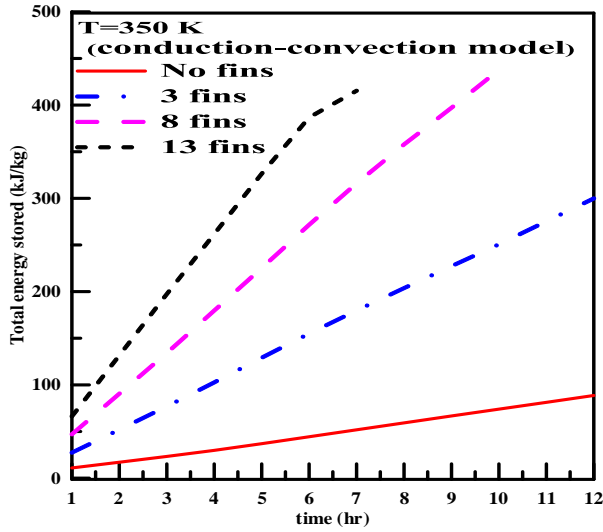

Fig. (16) The total energy stored in PCM versus time for various number of fins

4.3 Comparisons Between The Results Of The Two Models.

Fig (17) presents the relation between percentage increased in average liquid fraction between the convection-conduction model and the conduction model only, and time. It is seen from the figure that the percentage increase in average liquid fraction of PCM decreases with the increase of number of fins. This is because increasing number of fins reduces convection effect due to the reduction of space of PCM thickness. Fig (18) presents the relation between percentage increase in total energy stored in PCM and time. It is seen from the figure that the percentage increase in total energy of PCM decreases with the number of fins increase. This is because increasing fins reduced convection effect by reducing space of PCM.

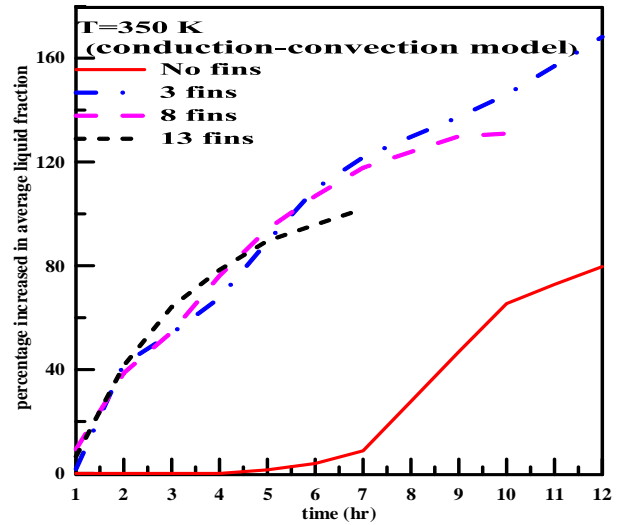

Fig (17) The relation between the percentage increased in average liquid fraction and time at various numbers of fins

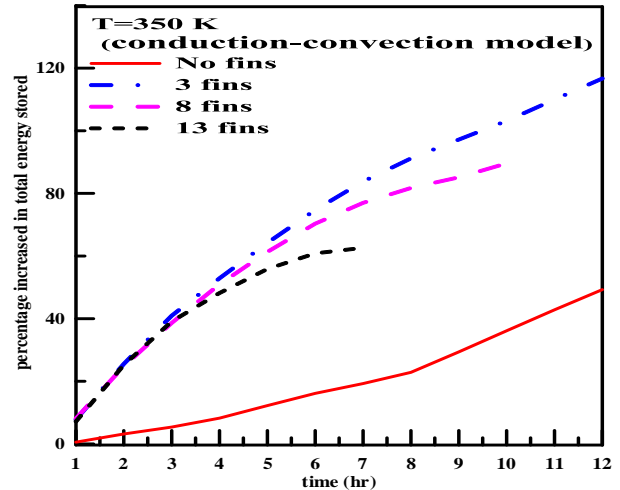

Fig (18) The relation between the percentage increased in total energy stored and time at various number of fins.

4.4 Effect Of Changing Heated Wall Temperature.

The following figures discusses the effect of heated wall temperature on liquid fraction and energy stored in PCM. The heated wall temperature is varied during the study and takes the value 350 K, 375 K and 400 K for the case of using 13 fins.

Fig (19) Presents the relation between average liquid fraction of PCM and time of

charging in three values of heated surface temperature namely $T=350\text{K}$, $T=375\text{K}$ and $T=400\text{K}$. It is seen from the figure that the liquid fraction increases rapidly with surface temperature which means that the time of melting decreases with the increase of surface temperature. For example the PCM completely melted after until 3 hours, 4 hours and 6.5 hours in the case of wall temperature ($T=400\text{K}$), ($T=375\text{K}$) and ($T=350\text{K}$) in the case of 13 fins.

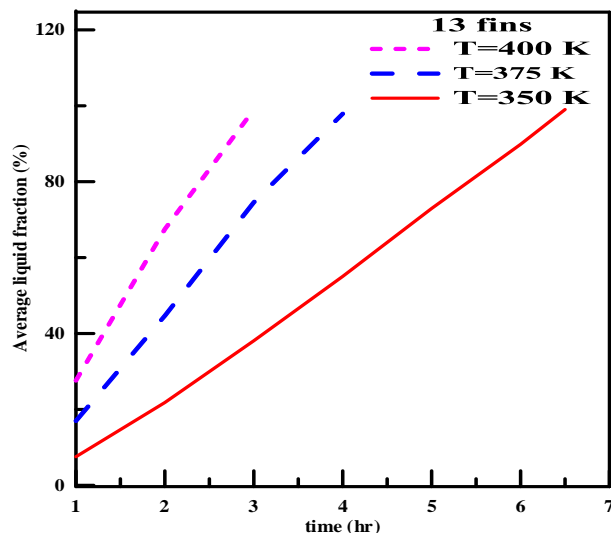

Fig (19) Transient variation of liquid fraction of PCM for various temperature at (13) fins

Fig (20) Present the relation between the total energy stored in PCM and time of charging in two cases the heated pipe temperature is ($T=350\text{K}$), ($T=375\text{K}$) and ($T=400\text{K}$). It is seen from the figure that the total energy stored in PCM increases faster with wall temperature.

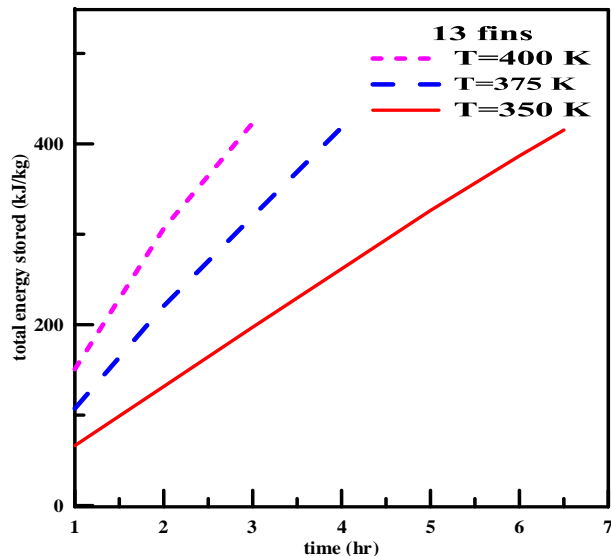

Fig (20) Total energy stored and time ($T=400\text{K}$), ($T=375\text{K}$) and ($T=350\text{K}$) for (13) fins.

5-Concolusions

From the results of the present study it can be concluded that:

- 1- Buoyancy force plays a great role during the melting process.
- 2- Liquid fraction and total energy stored in PCM increases with time for both conduction and conduction-convection models.
- 3- Increasing number of fins increases liquid fraction and total energy stored for conduction model
- 4- In conduction-convection model the least number of fins achieved maximum liquid fraction and energy stored when heating under constant wall temperature.
- 5- Time of melting of PCM decreases with the increase of number of fins. for both models.
- 6- Time of melting, liquid fraction and total energy stored more accurate using conduction-convection model.
- 7- Charging time decreases with the increases of heated surface temperature.

References

- [1] Assis, E., Katsman ,L.(2007). "Numerical and experimental study of melting in a spherical shell." *International Journal of Heat and Mass Transfer* 50(9–10): 1790-1804.
- [2] Bejan, A. (1994). "Contact melting heat transfer and lubrication." *Advances in heat transfer* 24: 1-38.
- [3] Boam, D. (1986). "Energy audit on a two-litre saloon car driving an ECE 15 cycle from a cold start." *Proceedings of the Institution of Mechanical Engineers, Part D: Journal of Automobile Engineering* 200(1): 61-67.
- [4] Groulx, D. , Ogoh, W. (2009). Solid-liquid phase change simulation applied to a cylindrical latent heat energy storage system. *COMSOL Conference* 2009.
- [5] Gumus, M. (2009). "Reducing cold-start emission from internal combustion engines by means of thermal energy storage system." *Applied thermal engineering* 29(4): 652-660.
- [6] Gumus, M., Ugurlu, A. (2011). "Application of phase change materials to pre-heating of evaporator and pressure regulator of a gaseous sequential injection system." *Applied Energy* 88(12): 4803-4810.
- [7] Halford, C. K.,Boehm, R. F. (2007). "Modeling of phase change material peak load shifting." *Energy and Buildings* 39(3): 298-305.
- [8] Hosseini, M. J., Ranjbar, A. A. (2012). "A combined experimental and computational study on the melting behavior of a medium temperature phase change storage material inside shell and tube heat exchanger." *International Communications in Heat and Mass Transfer* 39(9): 1416-1424.
- [9] Johansson, P. (2011). "Advanced Thermal Energy Storage Heat Transfer Study with Use of Comsol and Matlab.
- [10] "Khudhair, A. M., Farid, M. M. Farid (2004). "A review on energy conservation in building applications with thermal storage by latent heat using phase change materials." *Energy Conversion and Management* 45(2): 263-275.
- [11] Lamberg, P., Lehtiniemi,R. (2004). "Numerical and experimental investigation of melting and freezing processes in phase change material storage." *International Journal of Thermal Sciences* 43(3): 277-287.
- [12] Medrano, M., Yilmaz, M. O. (2009). "Experimental evaluation of commercial heat exchangers for use as PCM thermal storage systems." *Applied Energy* 86(10): 2047-2055.
- [13] Ogoh, W. (2010). "Numerical study of the effects of fins and thermal fluid velocities on the storage characteristics of a cylindrical latent heat energy storage system."
- [14] Reddy, M. R., Nallusamy, N.(2012). "Thermal energy storage system using phase change materials: Constant heat source." *Thermal Science* 16(4): 1097-1104.
- [15] Salyer, I., Sircar, A. (1986). Analysis of crystalline paraffinic hydrocarbons for thermal energy storage by differential scanning calorimetry; Part 1, Pure hydrocarbons. 15th North American Thermal Analysis Society Conference, Cincinnati, OH.
- [16] Schatz, O. (1992). Cold start improvement by use of latent heat stores, *SAE Technical Paper*.
- [17] Sebti, S., Khalilarya, S.(2011). "A numerical investigation of solidification in horizontal concentric annuli filled with nano-enhanced phase change material (NEPCM)." *World Applied Sciences Journal* 13(1): 09-15.

- [18] Sharma, A., Tyagi, V. V. (2009). "Review on thermal energy storage with phase change materials and applications." *Renewable and Sustainable Energy Reviews* 13(2): 318-345.
- [19] Vasiliev, L., Burak, V. (2000). "Latent heat storage modules for preheating internal combustion engines: application to a bus petrol engine." *Applied thermal engineering* 20(10): 913-923.
- [20] Vasiliev, L. L., Burak, V. S. (1999). "Heat storage device for pre-heating internal combustion engines at start-up." *International Journal of Thermal Sciences* 38(1): 98-104.
- [21] Wang, Y., Amiri, A. (1999). "An experimental investigation of the melting process in a rectangular enclosure." *International Journal of Heat and Mass Transfer* 42(19): 3659-3672.
- [22] Zhengguo, Z., Gang, S. (2005). "Study on paraffin/expanded graphite composite phase change thermal energy storage material." *Acta Energiae Solaris Sinica* 26(5): 698.