

## PERFORMANCE OF THREE-PRODUCT HYDROCYCLONE: DISTRIBUTION OF THE FEED SOLIDS CONTENT IN THE PRODUCT STREAMS

---

**G.A. Ibrahim; M.M. Ahmed, and**

*Mining and Metallurgical Engineering Department, Faculty of Engineering,  
Assiut University, Assiut 71516, Egypt*

**M.G. Farghaly**

*Mining and Petroleum Engineering Department, Faculty of Engineering,  
Al-Azhar University, Qena, Egypt*

*(Received September 18, 2006 Accepted March 29, 2007)*

*The hydrocyclone is considered one of the most important industrial separators. It has been used for more than 100 years due to its simple design, low cost, easy operation, and low maintenance. One of the most important areas of application of hydrocyclone in industry is the separation of solids from liquid. A cyclone used for this duty is usually referred to as a cyclone thickener. Under the general heading of the separation of solids from liquid; two extreme cases can be recognised. These are "thickening" and "clarification". A hydrocyclone as a single unit can not be used for this purpose efficiently. Accordingly, the concept of the three-product cyclone is developed from the need to have a cyclone which can be used efficiently in the separation of solid from liquid applications. In an attempt to put this concept into effect, a new design of three-product hydrocyclone has been developed to generate a third product in which the middling particles should be collected for further treatment.*

*In this paper, the design and operation of the three-product hydrocyclone are described. The influence of some parameters such as vortex finder diameter, middling opening diameter, and apex diameter on the solid percent recovered in the three products is investigated. The obtained results showed that the new three-product hydrocyclone has the ability to produce efficiently three different products according to their solids percent, water percent and particle size distributions.*

**KEYWORDS:** *Conventional Hydrocyclone, Three-product Hydrocyclone, Middling Flow Opening, Solids Recovery in the Three Products, Thickening,*

## NOMENCLATURE

<p>OF = overflow product</p> <p>MF = middling flow product</p> <p>UF = underflow product</p> <p><math>x_{25}</math> = the size which 25% of it will be retained</p> <p><math>x_{50}</math> = the size which has equal chance to be passed or retained</p> <p><math>x_{75}</math> = the size which 75% of it will be retained</p>	<p><math>x_{mean}</math> = the calculated mean size of the product</p> <p><math>d_o</math> = overflow diameter</p> <p><math>d_m</math> = middling flow diameter</p> <p><math>d_u</math> = underflow diameter</p> <p><math>S_o</math> = solid percent in the overflow product</p> <p><math>S_m</math> = solid percent in the middling flow product</p> <p><math>S_u</math> = solid percent in the underflow product</p>
--	--

## INTRODUCTION

Many industries exploit the benefits of hydrocyclone in a diverse range of application involving; solid-solid, solid-liquid, and even liquid-liquid separation. In spite of its apparent simplicity, the hydrocyclone is a multivariable device and has been the subject of intensive research work particularly in the last 100 years or so [1-4]. Various aspects of the hydrocyclone (influence of design and operating parameters, mathematical modelling and simulation, and design modification) have been thoroughly studied by many researchers in an effort to improve or more efficiently control its performance [5-10].

In the application of solid-liquid separation, a cyclone used for this duty is usually referred to as a cyclone thickener, and is designed for maximum efficiency with respect to recovery of all solids which are fed to it. Under the general heading of the separation of solids from liquid; two extreme cases can be recognised. These are "thickening" and "clarification", i.e. the separation of solid from liquid and the separation of liquid from solid, respectively [2]. A hydrocyclone as a single unit can not be used for this purpose efficiently [3,4]. Series connections of hydrocyclones (two-stage, three-stage, or more stages) then must be used to achieve the thickening process [2]. These series connections require special design of the connected hydrocyclones. The main features of this design are; small underflow apertures, very large overflow apertures, or high back pressure at the underflow [2]. Small underflow diameters may cause blockage while, very large overflow apertures, decrease both performance and operational efficiencies [2]. At high underflow back pressures, the core flow which replaces the air core can be too violent and cause re-entertainment of solids in the apex [2]. Moreover, these series connections require more constructional area and more capital and operational costs [3].

Accordingly, the concept of the three-product cyclone is developed from the need to have a cyclone which can be used efficiently in the separation of solid from liquid applications such as thickening and clarification. Trying to verify that, a recent modification of the hydrocyclone (three-product hydrocyclone) was developed in Julius Kruttschnitt Mineral Research Centre (JKMRC) [11,12]. In this modification, a conventional hydrocyclone was provided with a top cover plate and a second vortex finder inserted vertically inside the existing one to generate two overflows and an underflow. This modification concerns only with the fine region (overflow zone) where the conventional overflow stream is divided into two streams.

In an attempt to put this concept into effect, a new design of three-product hydrocyclone has been developed at the Mineral Processing Laboratories, Assiut University (MPLAU) to split the coarse fraction. The unit comprises a conventional cyclone modified with a third product opening location along the side of the unit, i.e. the unit has three openings; the conventional two openings and the additional third opening which was chosen tangentially on the cyclone periphery. This third opening is termed as the middling flow opening. This is a first step in an attempt to locate a middling opening in the hydrocyclone that produces a distinct third product from the cyclone unit.

## THE NEW THREE-PRODUCT HYDROCYCLONE

### Design

The three-product hydrocyclone is a conventional one modified with a third output opening along the side of the cyclone opposite to the feed opening. A detailed schematic of the modified cyclone unit is shown in Fig.1 (a, b, c, and d). From this Figure, it can be seen that the conical part has two openings; the conventional underflow opening and the middling flow opening. The middling flow opening was chosen in the lower third of the cone body just over its small diameter. The axis of this middling opening was designed to be horizontal. The modified conical part was designed to have the possibility to be equipped with the cylindrical part in any position with respect to the direction of feed inlet opening Fig. 2.

During all experiments, carried out through this work, the conical part was joined with the cylindrical part in a position at which the level of middling opening pipe is parallel to the level of feed inlet pipe and at the same side as shown in Fig. 3. This position was kept constant to be assured that the length of the feed plug path is the same in all experiments.

Two types of copper plugs having the same dimensions are used with this opening; one of them is solid from the two sides and is used to plug the middling flow opening when using the unit as a two-product hydrocyclone, and the other plug is opened from its two sides and is used in the case of three-

product hydrocyclone. The opened plugs are composed of copper tubes having different diameters to study the influence of this opening diameter on the separation process. All the plugs, when fitted to the cyclone, gave the same internal geometry of cone surface without any side effects on the pulp motion.

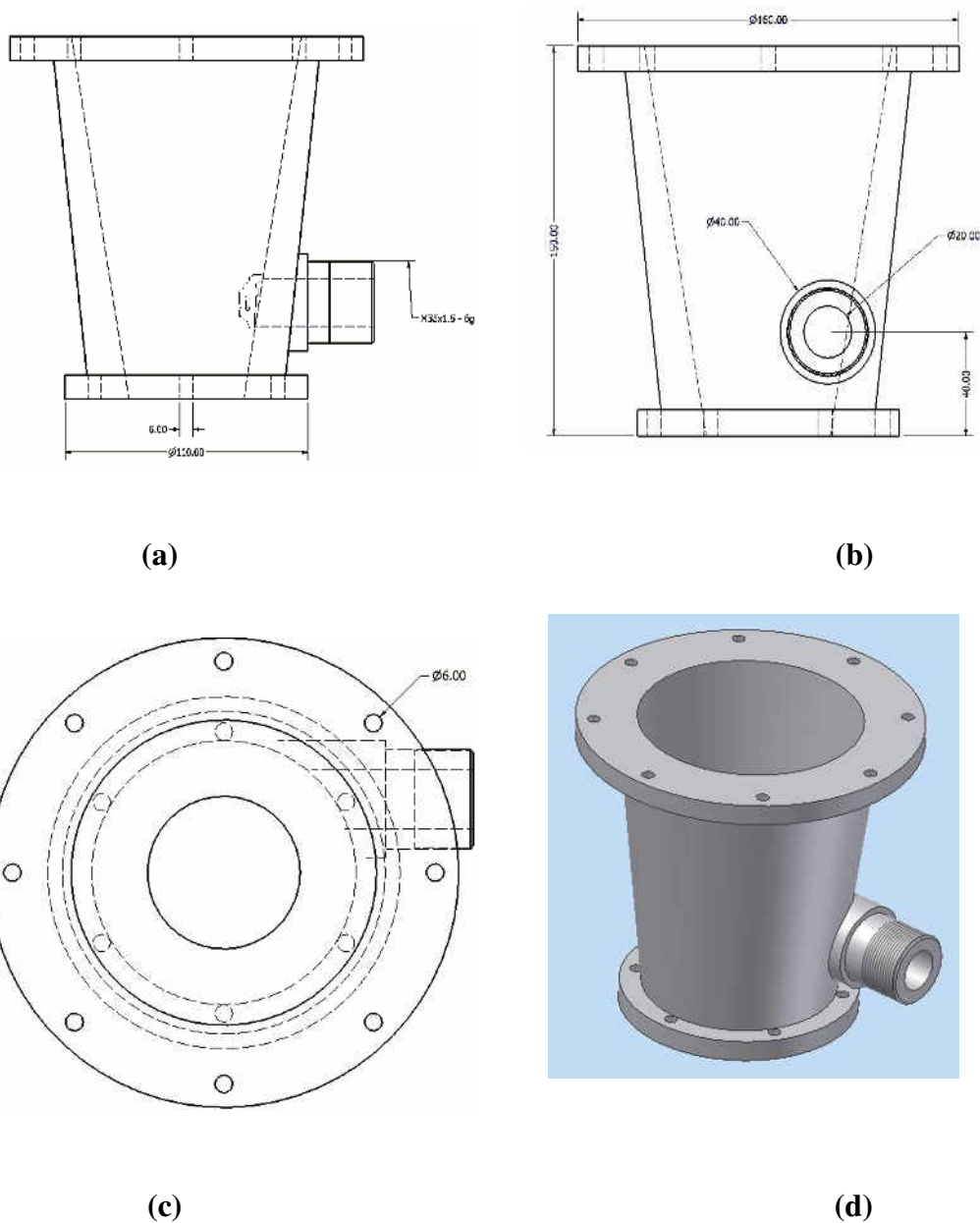

**Fig. 1:** Different views of the modified conical part of the new design three-product hydrocyclone

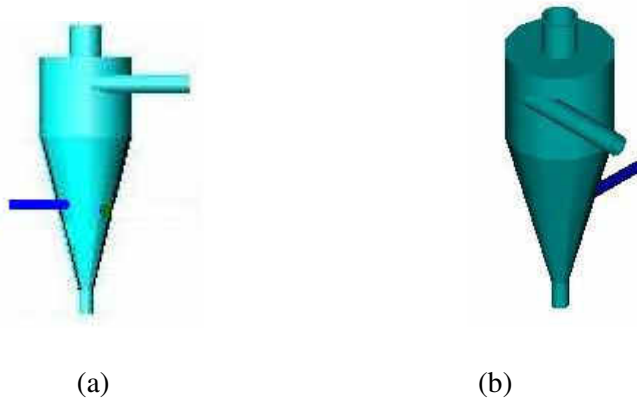

**Fig.2.** Different positions for connecting the modified conical part with the cylindrical part in the new designed three-product hydrocyclone

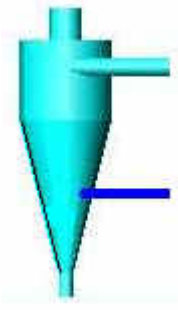

**Fig.3:** The connection of the modified conical part to the cylindrical part used in the experimental work

### Operation

The operation of the three-product hydrocyclone is similar to that of a conventional unit. Feed slurry is introduced under pressure via the tangential inlet and is constrained by the geometry of the unit to move into a circular path. This creates the opposing outward centrifugal and inwardly acting drag forces which result in a spiral flow pattern. An air core develops along the vertical axis which is connected to the atmosphere through the spigot, but the part created by dissolved air is coming out of solution in the low-pressure zone [13-15]. For the fine and light particles, the inward drag forces tend to dominate. Hence these particles move towards the vertical axis, join the innermost spiral and are swept up by the central current into the overflow opening. On the other hand, the large and heavy particles will experience a greater centrifugal force. They tend to move to the cyclone periphery, join the outermost spiral and move downward toward the spigot (underflow opening) [13-15].

## EXPERIMENTAL WORK

### Test Conditions

To provide the data on the operational performance of the three product hydrocyclone, a series of pilot scale tests was conducted using feed slurry consisting of quartz particles with a density of  $2650 \text{ kg/m}^3$ . The feed size distribution is shown in Table 1. The liquid phase was water. A three-product hydrocyclone of 100 mm in diameter and 435mm total length, at a constant inlet pressure of 10 psi was used. The variable parameters were; the overflow opening diameter in the range of 14-50 mm, the middling flow opening diameter in the range of 4-12 mm, and the underflow opening diameter in the range of 10-24 mm, where the inlet opening diameter was kept constant at 14mm with all other conditions.

**Table 1: Particle size distribution of the feed sample**

size, $\mu\text{m}$	-400 +315	-315 +250	-250 +200	-200 +160	-160 +125	-125 +100	-100 +63	-63
wt., %	5.25	15	25	7	3.5	4	12	28.25
Cum. wt. ret.%	5.25	20.25	45.25	52.25	55.75	59.75	71.75	100

### Test Rig

Figure 4 shows a schematic diagram of the rig used in this study. It comprises a 100-mm in diameter three-product hydrocyclone, a variable speed slurry pump and 80 litre baffled sump. The pressure drop across the cyclone was measured with a pressure gauge with a diaphragm mounted on the feed inlet pipe. Stirring of slurry in the sump was achieved by a mechanical agitator in conjunction with the turbulence created by the returning flows and baffles which ensured a complete suspension of solids in the sump.

### Test Procedure, Sampling and Data Analysis

In each test, the appropriate components are selected to obtain the desired three-product configuration. Feed slurry containing approximately 4.8 percent solid was prepared in the sump. After steady state condition is attained, the overflow, middling flow, and underflow streams are sampled simultaneously for a certain time. This was immediately followed by sampling of the feed stream. The slurry samples are weighed, filtered, dried and reweighed to calculate the flow rates and percent solids in the different products. The obtained results were mass balanced and used for subsequent calculations and interpretations.

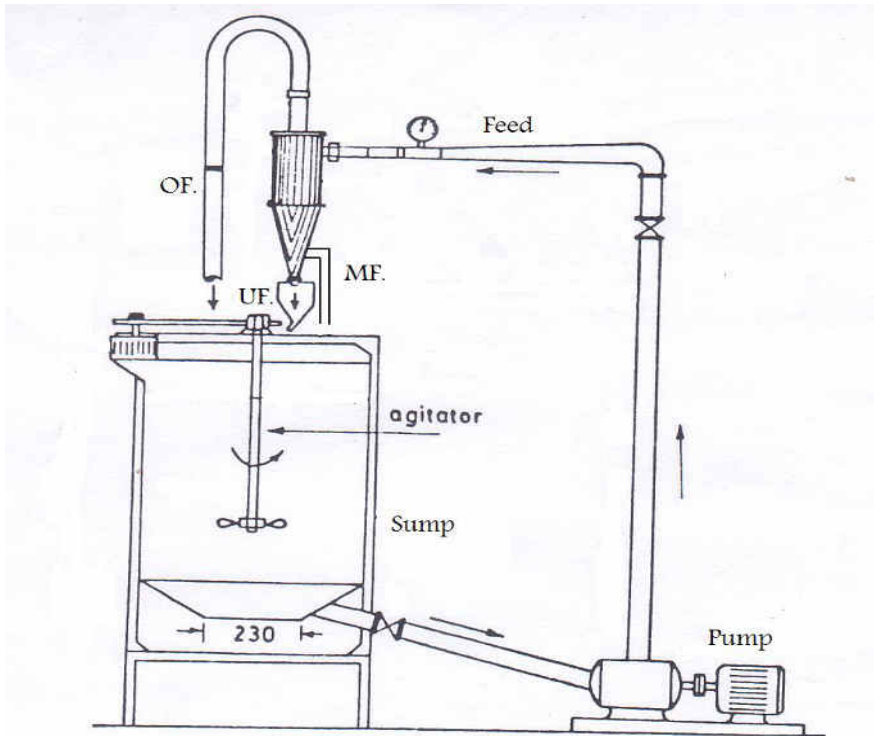

**Fig. 4:** A schematic diagram of the rig constructed at the Mineral Processing Laboratories, Faculty of Engineering, Assiut University

## RESULTS AND DISCUSSION

### Regression Models of the Solid Percent Separated in the Three-products

The effect of the variable parameters; overflow diameter ( $d_o$ ), middling flow diameter ( $d_m$ ), and underflow diameter ( $d_u$ ) on the split of feed into the three products was investigated through carrying out 115 experiments at different values of these diameters as shown in Table 2. Regression analysis was carried out using a software computer program.

**Table 2:** Values of the different opening diameters used in the experimental work

Variable	Value, mm
Overflow diameter	14, 24, 34, 45, 50
Middling flow diameter	4, 6, 8, 10, 12
Underflow diameter	10, 12, 16, 20, 24

**Regression model of the solid percent separated in the overflow product**

The regression model which correlates the solids percent separated in the overflow product ( $S_o$  %) with the variable parameters ( $d_o$ ,  $d_m$ , and  $d_u$ ) can be given by the following expression:

$$S_o (calc.) = 0.48d_o - 0.72d_m - 0.29d_u - 0.02d_o d_m - 0.001d_o d_u + 0.03d_m d_u + \frac{72.35}{d_o} - \frac{2.25}{d_m} + \frac{41.16}{d_u} - 1.4 \dots\dots\dots(1)$$

Where:

- $d_o$  = overflow diameter, mm
- $d_m$  = middling flow diameter, mm
- $d_u$  = underflow diameter, mm
- $S_o$  (calc.) = calculated values of the solid percent recovered in the overflow product

Comparison of the obtained experimental values of  $S_o$  and the calculated ones from Eq. (1) of the different experiments are shown in Fig. 5. The comparison assures that the suggested regression model fits well the experimental values of  $S_o$  with the operating variables where the obtained correlation coefficient between these calculated values and the experimental ones was about 0.95.

To examine the above equation for prediction of the solids percent recovered in the overflow product, new experiments were carried out using opening diameters ( $d_o$ ,  $d_m$ , and  $d_u$ ) different from those used to obtain the regression model. These conditions are shown in Table (3). Comparison of the obtained experimental values of  $S_o$  and the predicted ones determined from Eq. (1) of the new experiments are shown in Fig. 6 and Table (3). The comparison assures that the suggested regression model can predict well the experimental values of  $S_o$  with the different operating variables.

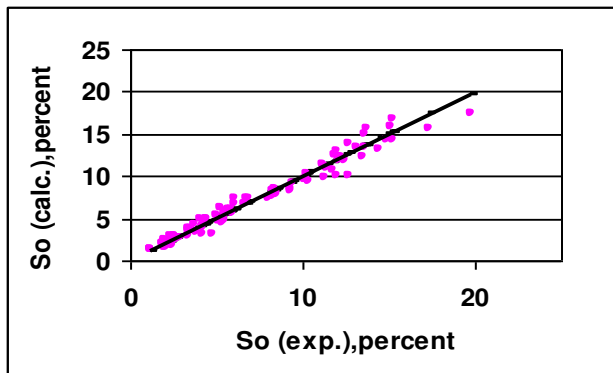
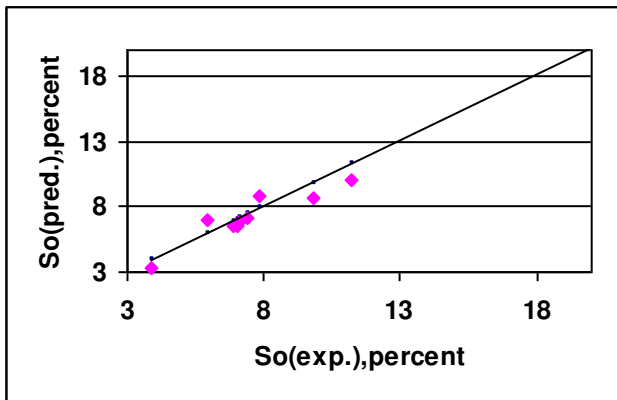

**Fig. 5:** Comparison of the experimental and calculated values of  $S_o$



**Table 3: Values of experimental and predicted solid percent recovered in the overflow product of the new experiments**

Exp. No.	d <sub>o</sub> , mm	d <sub>m</sub> , mm	d <sub>u</sub> , mm	S <sub>o</sub> (exp.), %	S <sub>o</sub> (pred.), %	Standard deviation, %
1	14	4	12	7.38	7.17	2.85
2	14	6	10	5.91	7.01	-18.61
3	24	4	12	7.83	8.89	-13.54
4	24	10	16	3.89	3.27	15.94
5	34	6	12	11.22	9.99	10.96
6	34	6	24	7.04	6.55	6.96
7	45	8	20	9.81	8.74	10.91
8	45	12	10	6.9	6.56	4.93
9	50	4	10	20.54	18.53	9.79
10	50	12	12	7.12	6.9	3.09



**Fig. 6:** Comparison of the experimental and predicted values of S<sub>o</sub> of the new experiments

**Regression model of the solid percent separated in the middling flow product**

The regression model which correlates the solids percent separated in the middling flow product (S<sub>m</sub> %) with the variable parameters (d<sub>o</sub>, d<sub>m</sub>, and d<sub>u</sub>) can be given by the following expression:

$$\begin{aligned}
 S_m (calc.) = & -0.0008d_o^3 - 0.126d_m^3 - 0.0018d_u^3 + 0.052d_o^2 + 2.17d_m^2 + 0.07d_u^2 \\
 & - 0.1655d_o d_m - 0.0172d_o d_u - 0.2814d_m d_u + 0.0002d_o^2 d_m^2 + 8.8 * 10^{-6} d_o^2 d_u^2 \\
 & + 0.0005d_m^2 d_u^2 - 8.02
 \end{aligned}$$

..... (2)

Where: S<sub>m</sub> (calc.) = calculated values of the solid percent recovered in the middling flow product

Comparison of the obtained experimental values of  $S_m$  and the calculated ones from Eq. (2) of the different experiments are shown in Fig. 7. The comparison assures that the suggested regression model fits well the experimental values of  $S_m$  with the operating variables where the obtained correlation coefficient between these calculated values and the experimental ones was about 0.95.

To examine the above equation for prediction of the solids percent recovered in the middling flow product, new experiments were carried out using opening diameters ( $d_o$ ,  $d_m$ , and  $d_u$ ) different from those used to obtain the regression model. These conditions are shown in Table (4). Comparison of the obtained experimental values of  $S_m$  and the predicted ones determined from Eq. (2) of the new experiments are shown in Fig. 8 and Table (4). The comparison assures that the suggested regression model can predict well the experimental values of  $S_m$  with the different operating variables.

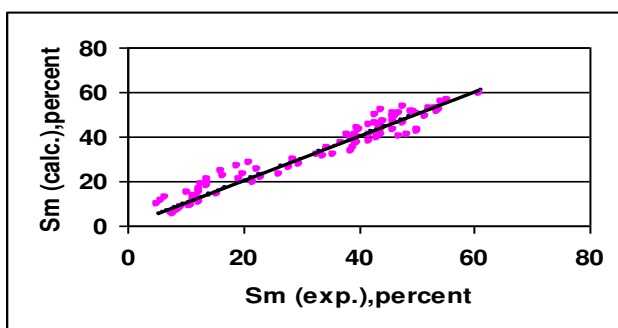
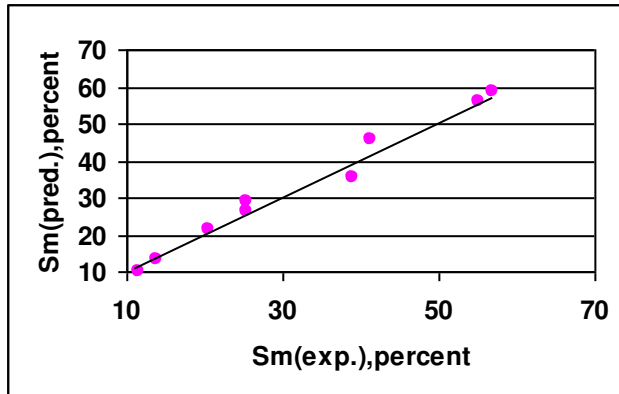

Fig. 7: Comparison of the experimental and calculated values of  $S_m$

Table 4: Values of experimental and predicted solid percent recovered in the middling flow product of the new experiments

Exp. No.	$d_o$ , mm	$d_m$ , mm	$d_u$ , mm	$S_m$ (exp.), %	$S_m$ (pred.), %	Standard deviation, %
1	14	4	12	11.65	9.84	15.54
2	14	6	10	25.47	26.18	-2.79
3	24	4	12	13.8	13.51	2.10
4	24	10	16	41.22	45.54	-10.48
5	34	6	12	25.31	28.92	-14.26
6	34	6	24	20.41	21.41	-4.90
7	45	8	20	39.08	35.16	10.03
8	45	12	10	57.03	58.84	-3.17
9	50	4	10	10.9	9.19	15.69
10	50	12	12	55.24	56.16	-1.67



**Fig. 8:** Comparison of the experimental and predicted values of  $S_m$  of the new experiments

**Regression model of the solid percent separated in the underflow product**

The regression model which correlates the solids percent separated in the underflow product ( $S_u$  %) with the variable parameters ( $d_o$ ,  $d_m$ , and  $d_u$ ) can be given by the following expression:

$$\begin{aligned}
 S_u (calc.) = & -\frac{1866265}{d_o^3} - \frac{36524}{d_m^3} - \frac{84781}{d_u^3} + \frac{243083}{d_o^2} + \dots \dots \dots (3) \\
 & \frac{17154}{d_m^2} + \frac{18722}{d_u^2} - \frac{9161}{d_o} - \frac{2229}{d_m} - \frac{15614}{d_u} + 276.8
 \end{aligned}$$

Where:  $S_u (calc.)$  = calculated values of the solid percent recovered in the underflow

Comparison of the obtained experimental values of  $S_u$  and the calculated ones from Eq. (3) of the different experiments are shown in Fig. 9. The comparison assures that the suggested regression model can fit well the experimental values of  $S_u$  with the operating variables where the obtained correlation coefficient between these calculated values and the experimental ones was about 0.95.

To examine the above equation for prediction of the solids percent recovered in the underflow product, new experiments were carried out using opening diameters ( $d_o$ ,  $d_m$ , and  $d_u$ ) different from those used to obtain the regression model. These conditions are shown in Table (5). Comparison of the obtained experimental values of  $S_u$  and the predicted ones determined from Eq. (3) of the new experiments are shown in Fig. 10 and Table (5). The comparison assures that the suggested regression model can predict well the experimental values of  $S_u$  with the different operating variables.

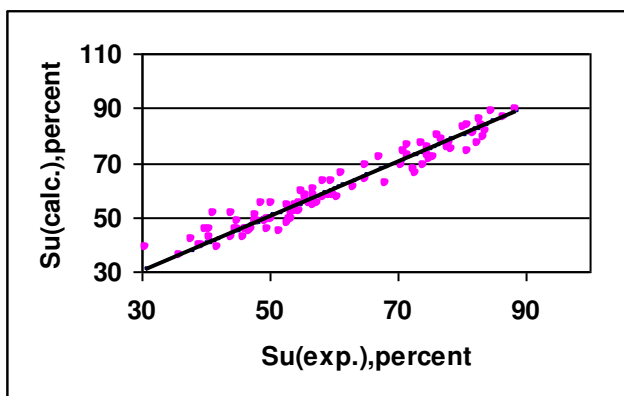

**Fig. 9:** Comparison of the experimental and calculated values of  $S_u$

**Table 5:** Values of experimental and predicted solid percent recovered in the underflow product of the new experiments

Exp. No.	$d_o$ , mm	$d_m$ , mm	$d_u$ , mm	$S_u$ (exp.), %	$S_u$ (pred.), %	Standard deviation, %
1	14	4	12	80.97	80.66	0.38
2	14	6	10	68.61	69.01	-0.58
3	24	4	12	78.37	80.23	-2.37
4	24	10	16	54.89	51.81	5.61
5	34	6	12	63.47	60.39	4.85
6	34	6	24	72.55	68.92	5.00
7	45	8	20	51.11	51.07	0.08
8	45	12	10	36.07	35.85	0.61
9	50	4	10	68.47	70.25	-2.60
10	50	12	12	37.64	42.71	-13.47

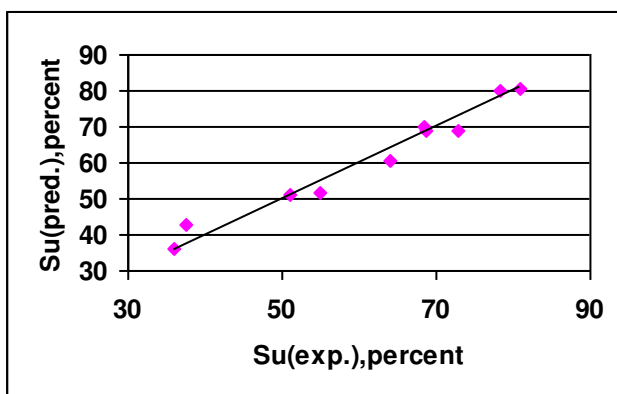

**Fig. 10:** Comparison of the experimental and predicted values of  $S_u$  of the new experiments

**Optimization of the Regression Model of the Solids Recovered in the Overflow Product**

Theoretically, the ideal separation process in the conventional hydrocyclone if was used as a dewatering tool is achieved only if all the feed water reports to the overflow product, i.e., no solids separate into the overflow product, and all the solids must be separated into the underflow product, i.e., no water separates in the underflow product [15,16]. The same manner may occur into the three-product hydrocyclone except that the solids will be divided between the middling flow product and the underflow product. This depends on the effect of the different parameters influencing the separation into the three-product hydrocyclone which will be studied and investigated in the further work.

In an attempt to get an overflow product with minimum solid percent from the three-product hydrocyclone, the feed solids percent recovered in the overflow product given by equation (1) should be minimized. For minimization  $S_o$ , equation 1 is then partially differentiated with respect to the different variables, i.e. overflow diameter, middling flow diameter, and underflow diameter. The following equations were obtained:

$$\frac{\partial S_o}{\partial d_o} = 0.48 - 0.02d_m - 0.001d_u - \frac{72.35}{d_o^2} \dots\dots\dots (4)$$

$$\frac{\partial S_o}{\partial d_m} = -0.72 - 0.02d_o + 0.03d_u + \frac{2.25}{d_m^2} \dots\dots\dots(5)$$

$$\frac{\partial S_o}{\partial d_u} = -0.29 - 0.001d_o + 0.03d_m - \frac{41.16}{d_u^2} \dots\dots\dots (6)$$

The above equations 4 through 6 are now being equated to zero and solved together to obtain the optimum values of operating variables. The optimum values of these variables are listed in Table (6).

**Table 6: The optimum values of  $d_o$ ,  $d_m$ , and  $d_u$  obtained in the case of thickening process in the three-product hydrocyclone**

Parameter	Value, mm
Overflow diameter ( $d_o$ )	24
Middling flow diameter ( $d_m$ )	6
Underflow diameter ( $d_u$ )	10

By inserting the optimum values of  $d_o$ ,  $d_m$ , and  $d_u$  into equations 1 through 3, the predicted values of  $S_o$ ,  $S_m$ , and  $S_u$  can be obtained. The final results can be summarized as follows:

1. The value of the solid percent separated in the overflow is low, ( $S_o = 8.35 \%$ ).
2. The value of the solid percent separated in the middling flow product is about

28.27%, ( $S_m = 28.27\%$ ).

3. The value of the solid percent separated in the underflow product is about 68.58%, ( $S_u = 68.58\%$ ).

From these results, it can be seen that, the sum of the solids percent predicted in the three products are about 105.2% instead of 100%. So, the difference was (5.2%) which may be attributed to the different degrees of accuracy of the regression models.

To check the results of the solids recovered in the three products obtained from the predicted models at the optimum values of  $d_o$ ,  $d_m$ , and  $d_u$ , a new experiment was carried out at these optimum values. The following results (experimental values of the solid percent separated in the three products) were obtained:

1.  $S_o(\text{exp.}) = 8.28\%$
2.  $S_m(\text{exp.}) = 21.14\%$
3.  $S_u(\text{exp.}) = 70.58\%$

From the above results it can be shown that the experimental values of  $S_o$ ,  $S_m$ , and  $S_u$  are in a good agreement with the predicted ones. The difference between the predicted and experimental values in  $S_m$  and  $S_u$  may be due to disturbance in the bottom of the cyclone because the two openings are very close to each other.

## **Characteristics of the Products Obtained from the Three-Product Hydrocyclone**

### **Particle size distributions in the three products**

Particle size analysis of the produced three products (overflow, middling flow, and underflow) for different experiments was done to determine  $x_{25}$ ,  $x_{50}$ ,  $x_{75}$ , and  $x_{\text{mean}}$  for each product. The obtained results are shown in Table (7).

From these results, it can be seen that, the three-product hydrocyclone produces three different products according to their particle size distributions. The characteristics of these three products can be summarized as follows:

1. The overflow product has a fine particle size ( $x_{\text{mean}}$  ranges from 21 to 31  $\mu\text{m}$ ),
2. The middling flow product has a moderate particle size ( $x_{\text{mean}}$  ranges from 139 to 181  $\mu\text{m}$ ), and
3. The underflow product has a coarse particle size ( $x_{\text{mean}}$  ranges from 182 to 226  $\mu\text{m}$ ).

### **Solids distributions in the three products**

The solids percent of the produced three products (overflow, middling flow, and underflow) for different experiments were calculated for each product from the mass balance of the feed and products pulp. The obtained results showed that, the three-product hydrocyclone can be used to produce three products

different in their solids distributions. The characteristics of these three products can be summarized as follows:

1. The overflow has low solids percent ranging from 2% to 10%.
2. The middling flow has a moderate solids percent ranging from 9% up to 40%
3. The underflow product has high solids percent ranging from 50% up to 89%.

**Table 7: Values of  $X_{25}$ ,  $X_{50}$ ,  $X_{75}$  and  $X_{\text{mean}}$  of the three products obtained for different experiments**

Exp. No.	Product	$X_{25}$ , mm	$X_{50}$ , mm	$X_{75}$ , mm	$X_{\text{mean}}$ , mm
1	OF.	10	25	40	29,38
	MF.	47	165	260	160,54
	UF.	115	215	280	201,00
2	OF.	12	28	45	30,54
	MF.	50	165	260	159,50
	UF.	82	210	290	191,16
3	OF.	15	25	42	30,55
	MF.	70	200	270	180,58
	UF.	175	250	290	226,00
4	OF.	10	20	35	26,06
	MF.	70	180	270	175,43
	UF.	150	230	290	214,09
5	OF.	12	22	45	29,70
	MF.	45	150	260	155,07
	UF.	115	230	269	204,00
6	OF.	10	20	40	25,88
	MF.	40	130	250	146,21
	UF.	140	240	290	210,00
7	OF.	10	15	40	24,55
	MF.	50	170	265	163,48
	UF.	85	210	285	191,02
8	OF.	8	18	35	23,23
	MF.	35	105	240	139,25
	UF.	90	220	285	192,62
9	OF.	8	18	35	24,09
	MF.	42	135	250	148,51
	UF.	70	205	280	183,39
10	OF.	5	15	30	21,34
	MF.	35	120	250	143,83
	UF.	75	200	275	182,15

## CONCLUSIONS AND FUTURE WORK

1. Regression models expressing the solid percentage separated in each product as a function of the overflow diameter ( $d_o$ ), the middling flow diameter ( $d_m$ ), and the underflow diameter ( $d_u$ ) were obtained.
2. Comparison of the experimental values of solids percent recovered in the three products and the predicted ones using regression analysis assures that the multi-variable models fits well the experimental values of solids percent with the operating variables where the obtained correlation coefficients were higher than 0.95.
3. The thickening process can be achieved through three-product hydrocyclone. This occurred at the optimum values of opening diameters ( $d_o = 24$  mm,  $d_m = 6$  mm, and  $d_u = 10$  mm) obtained from the minimization of solids percent recovered in the overflow product.
4. The three-product hydrocyclone has the ability to produce three different products according to their solids percent and particle size distributions.
5. Further tests are being conducted to investigate a range of design and operating parameters on the performance of the new cyclone.

## REFERENCES

- [1] Bradley, D., "The Hydrocyclone", Pergamon Press, Oxford, pp. 41-144, 1965.
- [2] Svarovsky, L., "Solid-Liquid Separation Processes and Technology", Elsevier, Amsterdam, 1985.
- [3] Svarovsky, L., "Hydrocyclones", Technomic Publishing Co., Lancaster, Pennsylvania, pp. 150-156, 1984.
- [4] Trawinski, H., "Practical aspects of the design and industrial applications of the hydrocyclone", Filtration and Separation Vol. (6), July 1969.
- [5] Trawinski, H., "Theory, application, and practical operation of hydrocyclone", Engineering and Mining Journal Vol. (9), pp. 115-127, 1976.
- [6] Yalcin, T., Kaukolin, E., Byers, A., "Axial inlet cyclone for mineral processing applications", Minerals Engineering Journal Vol.16, pp .1375-1381, 2003.
- [7] Olson, T., Ommen, R., "Optimizing hydrocyclone design using advanced CFD model", Minerals Engineering Journal Vol.17, pp. 713-720, 2003.
- [8] Molerus, O., Gluckler, M., "Development of a cyclone separator with new design", Powder Technology Journal Vol. 86, pp. 37-40, 1996.



- [9] Yalcin, T., Kaukolin, E., Byers, A., "Axial inlet cyclone for mineral processing applications", Minerals Engineering Journal Vol.16, pp. 1375-1381, 2003.
- [10] Obeng, D., P. and Morrell, S., "The JK three-product cyclone performance and potential applications", Int. J. Miner. Process, Vol. 69, pp. 129-142, 2002.
- [11] Mainza, A., Powell, M.S., Knopjes, B., "Differential classification of dense material in a three-product cyclone", Minerals Engineering Journal Vol.17, pp. 573-579, 2004.
- [12] Bednarski, S., "Three-product hydrocyclone for simultaneous separation of solids both heavier and lighter than liquid medium", Hydrocyclones Analysis and Application Vol.12, 397-404, 1992.
- [13] Liang-Yin, Wen-Mei, Xiao-Zhong., "Enhancement of hydrocyclone performance by controlling the inside turbulence structure", Chemical Science Engineering. Vol.57, pp. 207-212, 2001.
- [14] Dai, G., Q., Chen, J., M., Chu, L., Y., "Experimental study of solid-liquid two-phase flow in a hydrocyclone", Chemical Engineering Journal, Vol.74, pp. 211-216, 1999.
- [15] Rovinsky, L., A., "Application of separation theory to hydrocyclone design", Journal of Feed Engineering, Vol.26, pp. 131-146, 1995.
- [16] Firth, B., "Hydrocyclone in dewatering circuits", Minerals Engineering, Vol.16, pp. 115-120, 2003.

## أداء الهيدروسايكلون ثلاثي النواتج: توزيع المواد الصلبة الداخلة في تغذية

### الهيدروسايكلون في النواتج الثلاثة

يعتبر جهاز الهيدروسايكلون من أهم أجهزة الفصل المستخدمة في العديد من التطبيقات الصناعية المختلفة منذ أكثر من 100 عام وذلك نظرا لمميزاته العديدة التي يتمتع بها حيث انه سهل التصميم و التركيب، سهل التشغيل، لا يحتاج إلي صيانة معقدة. عند استخدام جهاز الهيدروسايكلون التقليدي (ثنائي النواتج) في عمليات فصل المكونات المختلفة مثل فصل المواد الصلبة من المواد السائلة كعمليات الترويق أو عمليات التعليل فإنه لا يعطي درجة فصل عالية. من هذا المنطلق ظهرت فكرة تصميم جهاز هيدروسايكلون جديد (ثلاثي النواتج) يمكن استخدامه في عمليات فصل المواد الصلبة من المواد السائلة. في محاولة لتنفيذ هذا التصور تم تصميم وتصنيع جهاز هيدروسايكلون ثلاثي النواتج للحصول علي منتج ثالث تتجمع فيه الحبيبات المتوسطة الحجم والتي يمكن استخدامها ومعالجتها فيما بعد. في هذا البحث تم استعراض تصميم الجهاز الجديد وتشغيله، كما تم دراسة تأثير أقطار الفتحات المختلفة

(قطر فتحة الخروج العلوية و قطر فتحة الخروج السفلية و قطر فتحة الخروج المتوسطة) علي نسبة المادة الصلبة التي يتم فصلها في المنتجات الثلاث وأظهرت النتائج أنه يمكن باستخدام الجهاز الجديد الحصول علي ثلاث منتجات مختلفه عن بعضها البعض من حيث نسبة المادة الصلبة و توزيع حجم الحبيبات في كل منتج من المنتجات الثلاثة وذلك بكفاءة جيدة.