

## VIDEO TRANSMISSION OVER CDMA CHANNELS WITH BIT-RATE ALLOCATION AND POWER OPTIMIZATION

---

**Usama Sayed Mohammed**

Electrical Engineering Department, Faculty of Engineering, Assiut University, Assiut, Egypt, Email: [Usama@aun.edu.eg](mailto:Usama@aun.edu.eg)

**Safwat M. Ramzy**

TELECOM EGYPT Assiut exchange Assiut, Egypt  
Email: [eng\\_safwat\\_mo@yahoo.com](mailto:eng_safwat_mo@yahoo.com)

(Received August 4 , 2007 Accepted January 24 , 2008)

*In this paper, a novel video transmission scheme for transmission of three dimensional set partitioning in hierarchical trees (3D-SPIHT) video coding streams over the CDMA channels is proposed. The main idea behind this scheme is that the output of the 3D-SPIHT video coding will be send related to its significant information. The modified 3D-SPIHT coder will generate three groups of bitstream. The significant bits, the sign bits, and the refinement bits are transmitted in three different groups. The optimal unequal error protection (UEP) of these groups is proposed. The RS code is used to test the effectiveness of the proposed scheme. In addition to UEP, the power optimization over the Code-division multiple access channels (CDMA) is done which increases the performance of our system. The simulation results indicate that the proposed scheme provides significantly better PSNR performance in comparison with the well-known robust coding schemes.*

**KEYWORD:** *channel coding; SPIHT coding; unequal error protection (UEP); rate allocation; RS codes; RCPC codes; 3D-SPIHT coding.*

### 1. INTRODUCTION

Wireless communication and networking have experience an unprecedented growth. The widespread availability and acceptance of wireless service make it the natural next step to support video transmission over wireless networks. With a broadband wireless network in place, the key bottleneck of wireless visual phone is video compression because full motion video requires at least 8 Mbps bandwidth. Wireless video will play a major role in shaping how new compression algorithms are defined and computer or network resources are used in the 21st century Standards transformation. The three-dimension set partition in hierarchical trees (3-D SPIHT) video coder [1], which is a 3-D extension of the celebrated SPIHT image coder [2], was chosen by Microsoft as the basis of its next-generation streaming video technology. The latest embedded video coder [3] showed for the first time that 3-D wavelet video coding outperforms MPEG-4 coding by as much as 2dB for most low motion and high motion sequences. CDMA is receiving considerable attention as the core multiple access technology in the development of upcoming third-generation (3G) wireless cellular networks [4]. Two

key features to be considered in wireless communication are power consumption and the data rate. The advantages of CDMA in cellular applications include improve channel capacity, error sensitivity. Wireless video is one of the most applications for 3G networks .The reliable transmission of wireless video provides an interesting problem for academic and industrial research. Multimedia services with various QoS requirements in CDMA networks can be controlled by appropriate controlling of transmitted power and transmission rate. This will be studied in this paper. Choosing power allocation as a means of adjusting the signal-to-noise ration (SNR) (hence packet loss ratios) of different CDMA channels, in the form of unequal power level assignment, provides an additional degree of freedom with respect to joint source and channel coding (JSCC) via error control alone, therefore can achieve higher overall peak signal to noise ratio (PSNR) values. Conceptually our work can be viewed as an extension of the work in [5].

## 2. SOURCE CODING AND FORWARD ERROR CORRECTION MODEL

In this section, the proposed scheme of source coding, packetization and forward error correction (FEC) coding adopted in our proposed system is described.

### 2.1 The Proposed Source Code and Packetization

Modification of the output bitstream of the 3D-SPIHT coder is done. The modification process is based on the type of bits and their contribution in the PSNR of the reconstructed image. The bit error sensitivity (BES) study is performed by first coding the original video using the 3-D SPIHT coder. Each time a bit is corrupted, the coded video is decoded and the resultant MSE is obtained. The resultant BES study is carried out on the video sequence “bridge-close” with QCIF format. On analysis, there are 3 major types of bit sensitivities within the 3D-SPIHT coded bits, as shown in Figure (1). Their description is described as follows: (1) the significance bit in the bit stream. It decides whether nodes in the LIP or LIS are significant, (2) the sign bit of a significant node that is transmitted after the significance bit, (3) the refinement bits that are transmitted during the refinement passes.

In Figure (1), the order of significance from the most significant types of bits to the least significant is: significance bits > sign bits > refinement bits. In the first step of the proposed scheme, the 3D-SPIHT coder will be modified to generate three groups of bit stream related to the order of significance i.e.; the output bit stream will be started by the most significant types of bits (first group of bits). An embedded bit stream is generated as described before for each GOF, each bit stream then is partitioned into a sequence of packet in the proper order, and the  $l$ -th packet assigned to the  $l$ -th source layer,  $l = 1, \dots, L$ .

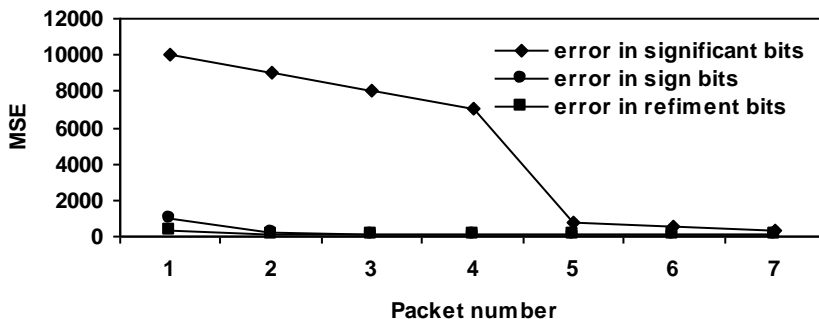

Fig.1. Error bit sensitivities within the 3D- SPIHT coded bit stream

### 2.2. FEC Coding

Each source layer is partitioned into coding blocks having  $K$  source packets per coding block. For each block of  $K$  source packets in a source layer, assuming that  $N_{max} - K$  parity packets are produced using a systematic  $((N_{max}, K))$  RS style erasure correction code [6, 7].

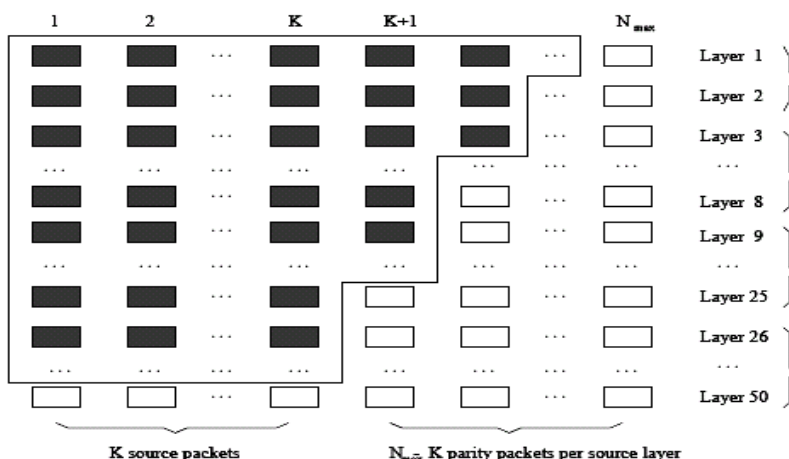

Fig.2. Relationships between source/parity layers and channels. The transmitted packets are highlighted. Packets as a layer and will be assigned to the same channel.

Assume that a total of 4 CDMA channels are used to transmit the 50 layers of source/parity data packets, as shown in Figure (2). The transmitter now has many layers to send. It can transmit any collection of source layers and any collection of parity packets associated with those source layers. The transmitter buffers frames as they arrive. When a group of frame (GOF) is accumulated, it encodes the GOF and packetize the resulting layered bitstream. After  $K$  such GOFs, the transmitter computes the  $N_{max} - K$  parity packets for each coding block of  $K$  source packets.

For a fixed transmission rate and a fixed power level, the transmitter chooses to transmit the optimal number of source and parity packets highlighted in Figure (2), based on the optimization procedure given in Section (4). Playback begins after exactly  $K$  GOF of coding delay. The proposed scheme can be summarized as follows: (1) the 3D-SPIHT video coding technique is modified to generate three groups of bitstream related to the order of significance, (2) the output data is partitioned into a sequence of packets, (3) the changing in MSE is calculated and the expected decrease in distortion  $\Delta D_i$  is then approximately estimated, (4) the optimization algorithm is applied to generate the optimum bit rate for each group of bits. The inputs to the optimization algorithm are the packet length, the bit error rate (BER), and  $\Delta D_i$ , (5) the output rate allocation vectors is used with RS codes to generate the transmitted bitstream, (6) the receiver will decode the receiving bitstream by using RS decoder and the modified the 3D-SPIHT decoder. Figure (3) shows the block description of the proposed scheme.

### 3. CDMA CHANNEL AND LINEAR MMSE MULTI-USER DETECTION

In this work, the video data packets are transmitted through CDMA channels [5]. The linear multiuser receiver for demodulating the received data is considered. Specifically, both the exact linear MMSE multiuser detector when the channel conditions are known to the receiver (i.e., uplink); and the blind linear MMSE receiver when the channel conditions are unknown to the receiver (i.e., downlink) is considered.

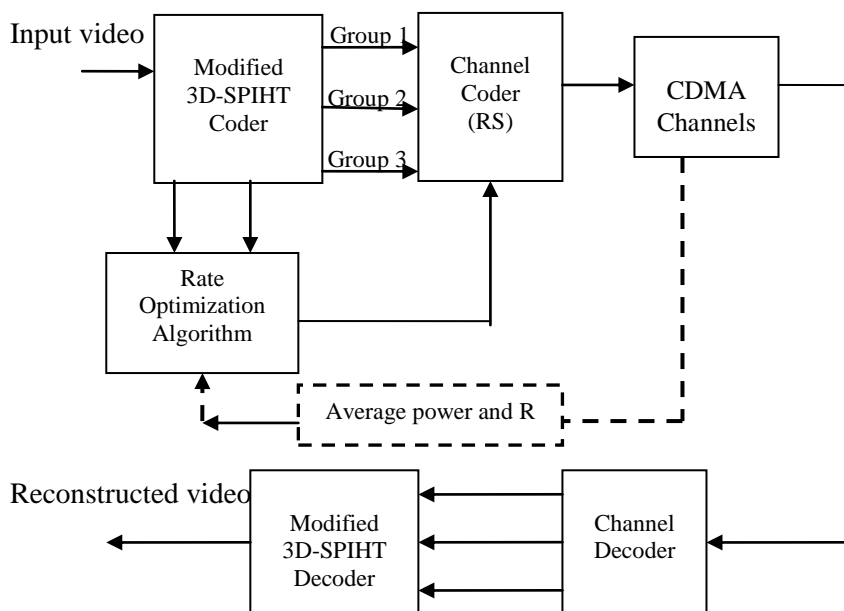

Fig.3. The Proposed Scheme

### 3.1. Synchronous CDMA Signal Model

The most basic multiple-access signal model is introduced, namely, a baseband,  $G$ -user, time-invariant, synchronous, additive white Gaussian noise (AWGN) system, employing periodic (short) spreading sequences and operating with a coherent BPSK modulation format. The continuous-time waveform is received by a given user in such a system can be modeled as follows:

$$r(t) = \sum_{k=1}^G \sqrt{P_k} \sum_{i=0}^{M-1} b_k[i] s_k(t - iT) + n(t), \tag{1}$$

Where  $M$  is the number of data symbols per user in the data frame of interest;  $T$  is the symbol interval;  $P_k, \{b_k[i]\}_{i=0}^{M-1}$  and  $s_k(t)$  denote respectively the power level, the transmitted symbol stream, and the normalized signaling waveform of the  $k$ -th user; and  $n(t)$  is the baseband white Gaussian ambient channel noise with power spectral density  $\sigma^2$ . It is assumed that for each user  $k, \{b_k[i]\}_{i=0}^{M-1}$  is a collection of independent equiprobable  $\pm 1$  random variables, and the symbol streams of different users are independent. The user signaling waveform is of the form

$$s_k(t) = \frac{1}{\sqrt{N}} \sum_{j=0}^{N-1} c_{j,k} \psi(t - jT_c) \quad 0 \leq t < T, \tag{2}$$

Where  $N$  is the processing gain;  $\{c_{j,k}\}_{j=0}^{N-1}$  is signature sequence of  $\pm 1$  assigned to  $k$ -th user; and  $\psi(\cdot)$  is a chip waveform of duration  $T_c = \frac{T}{N}$  and with unit energy

i.e.,  $\int_0^{T_c} \psi(t)^2 dt = 1$ .

At the receiver, the received signal  $r(t)$  is filtered by a chip-matched filter and then sampled at the chip rate. The sample corresponds to the  $j$ -th chip of the  $i$ -th symbol is given by

$$r_j[i] = \int_{iT+jT_c}^{iT+(j+1)T_c} r(t) \psi(t - iT - jT_c) dt, \quad j = 0, \dots, N - 1; i = 0, \dots, M - 1 \tag{3}$$

The discrete-time signal of the  $i$ -th symbol is then given by

$$r[i] = \sum_{k=1}^G \sqrt{P_k} b_k[i] s_k + n[i] = s \sqrt{P} b[i] + n[i], \tag{4}$$

$$r[i] = \begin{bmatrix} r_0[i] \\ r_1[i] \\ \vdots \\ r_{N-1}[i] \end{bmatrix}, s_k = \frac{1}{\sqrt{N}} \begin{bmatrix} C_{0,k} \\ C_{1,k} \\ \vdots \\ C_{N-1,k} \end{bmatrix}, n[i] = \begin{bmatrix} n_0[i] \\ n1[i] \\ \vdots \\ n_{N-1}[i] \end{bmatrix}, \tag{5}$$

Where  $n_j[i] = \int_{iT+jT_c}^{(j+1)T_c} n(t) \psi(t - iT - jT_c) dt$ ,

$$S = [s_1, \dots, s_G]; P = \text{diag} = (P_1, \dots, P_G); b[i] = [b_1[i], \dots, b_G[i]]^T$$

### 3.2. Linear MMSE Detector

Suppose that we are interested in demodulating the data bits of a particular user, say user 1,  $\{b_k[i]\}_{i=0}^{M-1}$  based on the received waveforms  $\{r[i]\}_{i=0}^{M-1}$ . A linear receiver for this purpose is a vector  $w_1 \in \mathbb{R}^N$ , such that the desired user's data bits are demodulated according to

$$z_1[i] = w_1^T r[i] \quad (6)$$

$$b_1 = \text{sig} \{z_1[i]\} \quad (7)$$

Substituting (4) into (6), the output of the linear receiver  $w_1$  can be written as

$$z_1[i] = \sqrt{P_1} (w_1^T s_1) b_1[i] + \sum_{k=2}^G \sqrt{P_k} (w_1^T s_k) b_k[i] + w_1^T n[i] \quad (8)$$

In Eq. (8), the first term contains the useful signal of the desired user; the second term contains the signals from other undesired users – the so-called multiple-access interference (MAI); and the last term contains the ambient Gaussian noise. The simplest linear receiver is the conventional matched-filter, where  $w_1 = s_1$ . It is well known that such a matched-filter receiver is optimal only in a single-user channel (i.e.  $G = 1$ ). In a multiuser channel (i.e.,  $G > 1$ ), this receiver may perform poorly since it makes no attempt to ameliorate the MAI, a limiting source of interference in multiple-access channels. The linear minimum mean-square error (MMSE) detector is designed to minimize the total effect of the MAI and the ambient noise at the detector output. Specifically, it is given by the solution to the following optimization problem.

$$w_1 = \arg \min_{w \in \mathbb{R}^N} E\{(b_1[i] - w^T r[i])^2\} = C_r^{-1} s_1 \quad (9)$$

$$C_r = E\{r[i]r[i]^T\} = \sum_{k=1}^G P_k S_k S_k^T + \sigma^2 I_N = S P S^T + \sigma^2 I_N \quad (10)$$

Denote the normalized cross-correlation matrix of the signal set  $s_1, \dots, s_G$

$$R = S^T S = \begin{pmatrix} \rho_{11} & \dots & \rho_{1G} \\ \dots & \dots & \dots \\ \dots & \dots & \dots \\ \rho_{G1} & \dots & \rho_{GG} \end{pmatrix}, \quad (11)$$

Where  $\rho_{ij} = s_i^T s_j$ .

Since it is assumed that the user bits are independent, and the noise is independent of the user bits, following [8, 9, 10, 11], the signal-to-interference-plus noise ratio (SNR) at the output of the linear detector  $w_1$  is given by

$$SNR = \frac{P_1 (w_1^T s_1)^2}{\sum_{k=2}^G P_k (w_1^T s_k)^2 + \sigma^2 \|w_1\|^2} \quad (12)$$

Where

$$w_l^T s_k = \frac{1}{P_l} [R(R + \sigma^2 P^{-1})^{-1}]_{k,l}, k, l = 1, \dots, G \tag{13}$$

$$\|w_1\|^2 = \frac{1}{P_1^2} [(R + \sigma^2 P^{-1})^{-1} R (R + \sigma^2 P^{-1})^{-1}]_{1,1} \tag{14}$$

It is shown in [12] that the output of a linear MMSE detector is well approximated by a Gaussian distribution. Thus the bit error rate can be expressed as:

$$p_{b,1} = Q(\sqrt{SNR}) \tag{15}$$

### 3.3. Blind Detector

It is seen from (9) that the linear MMSE detector  $w_1$  is a function of the signature sequences  $S$  of all  $G$  users. Recall that for the matched-filter receiver, the only prior knowledge required is the desired user's signature sequence  $s_1$ . In the downlink of a CDMA system, the mobile receiver typically only has the knowledge of its own signature sequence, but not of those of the other users. Hence it is of interest to consider the problem of blind implementation of the linear detector, i.e., without the requirement of knowing the signature sequences of the interfering users. Let the Eigen decomposition of  $C_r$  in (10) be

$$C_r = U_s A_s U_s^T + \sigma^2 U_n U_n^T \tag{16}$$

Where  $A_s = \text{diag}(\lambda_1, \lambda_2, \dots, \lambda_G)$  contains the largest  $G$  eigen-values of  $C_r$ ;  $U_s = [u_1, \dots, u_G]$ ; Contains the eigenvectors corresponding to the largest  $G$  eigen-values in  $A_s$ ;  $U_n = [u_{G+1}, \dots, u_N]$ , contains the  $(N-G)$  eigenvectors corresponding to the smallest eigen values  $\sigma^2$  of  $C_r$ . It is known that  $\text{range}(U_s) = \text{range}(S)$  is the signal subspace; and  $\text{range}(U_n) \perp \text{range}(S)$  is the noise subspace. The linear MMSE detector  $w_1$  in (11) can also be written in terms of the signal subspace components as (6)

$$w_1 = U_s A_s^{-1} U_s^T s_1 \tag{17}$$

Corresponding to the two forms of the linear MMSE detector (9) and (17), there are two approaches to its blind implementation. In the direct-matrix-inversion (DMI) method, the autocorrelation matrix  $C_r$  in (9) is replaced by the corresponding sample estimate.

$$\hat{C}_r = \frac{1}{M} \sum_{i=1}^M r[i]r[i]^T, \tag{18}$$

$$\hat{w}_1 = \hat{C}_r^{-1} s_1, \quad \text{[DMI blind linear MMSE detector]} \tag{19}$$

That is in the subspace method, the Eigen components  $A_s$  and  $U_s$  in (17) are replaced by the corresponding eigenvalues and eigenvectors of the sample autocorrelation matrix  $\hat{C}_r$ . That is

$$\hat{C}_r = \frac{1}{M} \sum_{i=1}^M r[i]r[i]^T = \hat{U}_s \hat{A}_s \hat{U}_s^T + \hat{U}_n \hat{A}_n \hat{U}_n^T \tag{20}$$

$$\hat{w}_1 = \hat{U}_s \hat{A}_s \hat{U}_s^T s_1 \text{ [Subspace-blind-linear-MMSE-detector]} \tag{21}$$

Where  $\hat{A}_s$  and  $\hat{U}_s$  contain respectively the largest  $G$  eigenvalues and the corresponding eigenvectors of  $\hat{C}_r$ ;  $\hat{A}_n$  and  $\hat{U}_n$  contain respectively the remaining eigenvalues and eigenvectors of  $\hat{C}_r$ . According to [6,7,8], the output SNR of the blind detector can be expressed as follows:

$$\frac{P_1(w_1^T s_1)^2}{\sum_{k=2}^G P_k (w_k^T s_k)^2 + \sigma^2 \|w_1\|^2 + \frac{1}{M} [(G+1)w_1^T s_1 - 2 \sum_{k=1}^G P_k^2 (w_k^T s_k)^2 w_k^T s_k + (N-G)\tau\sigma^2]} \tag{22}$$

Where  $w_l^T s_k$  and  $\|w_1\|^2$  are given respectively by (13) and (14), and

$$\tau\sigma^2 = \begin{cases} w_1^T s_1, & \text{[DMI blind detector]} \\ \frac{\sigma^4}{P_1^2} [(R + \sigma^2 P^{-1})^{-1} P^{-1} R^{-1}]_{1,1}, & \text{[subspace blind detector]} \end{cases} \tag{23}$$

Note that the last term in the denominator of (22) represents the noise power due to the estimation error. Also note that the performance difference between the two forms of blind detectors is due to the term  $\tau$  given by (23). It is shown in [8, 9, 10,11] that in realistic channels the subspace blind detector outperforms the DMI blind detector and that the output of the blind detector is approximately Gaussian. Therefore the BER can be expressed as

$$P_{b,1} = Q(\sqrt{SNR}) \tag{24}$$

In our proposed system for video transmission over CDMA networks, the video stream occupies up to 4 CDMA channels. The other users in the same network act interference.

### 4. PROBLEM FORMULATION

Let  $G$  be the number of CDMA channels used for transmitting a video stream (in this work,  $G = 4$ ). Denote  $P = [P_1 P_2 \dots P_G]$  as the power level allocation vector for the transmitted powers of the  $G$  channels used for transmitting the video data packets. One of our objectives is to optimize the power allocation  $P$  vector subject to a total power constraint such that the distortion is minimized. Note that, from Section (3), the bit error rate and therefore the packet loss probability a channel depend on the power levels of all channels, not just the power of that particular channel. Let  $L_j$  be the number of source layers transmitted over the  $j$ -th channel (in this work,  $L_1 = 8; L_2 = 8; L_3 = 9$  and  $L_4 = 25$ ). Then the total number of source layers

$$L = \sum_{j=1}^G L_j \tag{25}$$



Let  $K$  be the number of source packets per code block per source layer;  $N_{\max}$  be the maximum number of source packets plus parity packets per code block; and  $N_i$  ( $0 < N_i \leq N_{\max}$ ) be the number of source packets plus parity packets in the code block for the  $i$ -th source layer transmitted (see highlighted packets in Fig(2)). Let

$r_j = \frac{N_j}{K}$  as the redundancy per GOF transmitted to the receiver for the  $i$ -th layer.

$r = (r_1, r_2, \dots, r_l)$  is called the rate allocation vector [7]. The rate allocation vector specifies how many source and parity packets to transmit for each source layer when the transmitter transmits the first  $l$  source layers. In this way, the rate allocation vector specifies the allocation of the total transmission rate between source packets and parity packets. Any given rate allocation vector  $r$  induces a total transmission rate (in terms of transmitted packets per GOF)

$$R(r) = \sum_{i=1}^l r_i = \frac{1}{K} \sum_{i=1}^l N_i \tag{26}$$

Given a specified data rate, we can determine the number of source layers  $l$ , to be transmitted. Assume these layers are transmitted using up to  $\bar{G}$  CDMA channels. The total distortion at the receiver is given by

$$D(r, p) = D_0 - \sum_{i=1}^l pp_i \Delta D_i \tag{27}$$

Where  $D_0$  is the expected distortion when the rate is zero,  $pp_i$  is the probability that the first  $i$  layers are decoded correctly, and  $l$  is the number of source layers that the transmitter chooses to send. The probability  $pp_i$  can be written in the form:

$$pp_i = \prod_{j=1}^i Q_j(r_j, p) \tag{28}$$

Where  $Q_j(r_j, p)$  is the probability that the  $j$ -th layer of source packet is received correctly when sending by rate of  $r_j$  and with power  $P_j$ . Let the  $j$ -th layer packets be transmitted through the CDMA channel and  $S_j(p)$  be the packet loss probability of the  $j$ -th layer. Assume the bit error occurs independently, and then the packet loss probability for the  $j$ -th layer can be written as

$$S(p) = 1 - [1 - p_c(j)]^{n_b} \tag{29}$$

Where  $p_c(j)$  is given by (15) for the exact linear MMSE detector or given by (24) for the blind detectors;  $n_b$  is the packet size in bits (in this work,  $n_b = 8000$  bits). When  $N_j \geq K$  and assume that a  $(N_j, K)$  RS style erasure code is used. Then

$$Q_j(r_j) = \frac{EP(r_j, k, S_j(P))}{k} \tag{30}$$

Where  $EP(r_j, k, S_j(P))$  is the expected number of source packets that can be recovered and it can be written as follows:

$$EP(r_j, k, S_j(P)) = \sum_{v=1}^{k-1} \binom{r_j}{v} S_j(P)^{r_j-v} (1 - S_j(P))^v \binom{v}{r_j} + \sum_{v=k}^{r_j} \binom{r_j}{v} S_j(P)^{r_j-v} (1 - S_j(P))^v k \tag{31}$$

And the total distortion at the receiver can be written as follows:

$$D(r, p) = D_0 - \sum_{i=1}^1 \left( \prod_{j=1}^i Q_j(r_j, p) \right) \Delta D_i \tag{32}$$

With the distortion expression in equation (32) for any rate allocation vector  $r_j$  we can minimize the expected distortion subject to a transmission rate constraint. The problem can be formulated as follows:

$$\min_{r, p} D(r, p) \quad \text{subject to} \quad \sum_{j=1}^1 r_j \leq R \quad \text{and} \quad \sum_{k=1}^{\bar{G}} P_k \leq P \tag{33}$$

Hence, with the expected distortion expression in equations (32), (33) for any rate allocation vector  $r_j$ , we can optimize the rate vector to minimize the expected distortion subject to a transmission rate constraint.

### 5. THE OPTIMIZATION TECHNIQUE

Equation (33) can be solved by finding the rate allocation vector  $r$  that minimizes the Lagrange equation

$$J(r, p, \lambda_1, \lambda_2) = D(r, p) + \lambda_1 \sum_{i=1}^1 r_i + \lambda_2 \sum_{k=1}^{\bar{G}} P_k = D_0 + \sum_{i=1}^i [(-\prod_{j=1}^i Q_j(r_j, p)) \Delta D_i + \lambda_i r_i] + \lambda_2 \sum_{k=1}^{\bar{G}} P_k \tag{34}$$

The solution of this problem is characterized by the set of distortion increment  $\Delta D_i$ , and  $Q_j(r_j, p)$  with which the  $j$ -th layer source packet is recovered correctly. In this work, the problem is solved by using an iterative approach that is based on the method of alternating variables [14]. The objective function  $J(r_1, \dots, r_i, p_1, \dots, p_G)$  in equation (34) is minimized one variable at a time, keeping the other variables constant, until convergence. To be specific, let  $r^{(0)}$  and  $p^{(0)}$  be any initial rate allocation vector and let  $r^{(t)} = (r_1^{(t)}, \dots, r_i^{(t)})$  and  $p^{(t)} = (p_1^{(t)}, \dots, p_G^{(t)})$  be determined for  $t=1, 2, \dots$  as follows: select one component,  $x \in \{r_1, \dots, r_i, p_1, \dots, p_G\}$  to optimize at step  $t$ . This can be done in a round-robin style. Then, for  $x = r_i$  we can perform the following rate optimization:

$$\begin{aligned}
 r_i^{(t)} &= \arg \min_{r_i} J(r_1^{(t)}, \dots, r_{i-1}^{(t)}, r_i^{(t)}, P_1^{(t)}, \dots, P_G^{(t)}) \\
 &= \arg \min_{r_i} \sum_{v=1}^l (-\prod_{j=1}^v Q_j(r_j, p)) \Delta D_v + \lambda r_i
 \end{aligned}
 \tag{35}$$

If  $x = p_k$ , then we perform the following power optimization

$$\begin{aligned}
 p_k^{(t)} &= \arg \min_{p_k} J(r_1^{(t)}, \dots, r_l^{(t)}, p_1^{(t)}, \dots, p_k^{(t)}, \dots, p_G^{(t)}) \\
 &= \arg \min_{p_k} \sum_{v=1}^l (-\prod_{j=1}^v Q_j(r_j, p)) \Delta D_v + \lambda_2 p_k
 \end{aligned}
 \tag{36}$$

For fixed  $\lambda_1, \lambda_2$  the one-dimensional minimization problems (35) and (36) can be solved using standard non-linear optimization procedures [14]. In order to minimize the Lagrangian  $J(r, P, \lambda_1, \lambda_2)$  given by (34), The following process is done: first for fixed  $(\lambda_2, P)$ ,  $J(r, P, \lambda_1, \lambda_2)$  is minimized over  $(\lambda_1, r)$ , then for fixed  $(\lambda_1, r)$ ,  $J(r, P, \lambda_1, \lambda_2)$  is minimized over  $(\lambda_2, P)$ . In our experiments, the initial rate allocation vector is started by  $r = (1, 1, \dots, 1)$  and the initial power allocation vector  $P = (\bar{P}, \bar{P}, \dots, \bar{P})$  where  $\bar{P}$  the average power.

### 6. SIMULATION RESULTS

The simulation of our proposed scheme is applied on real data transmitted over a simulated wireless CDMA environment. For linear MMSE detection in CDMA uplink, the total number of channels is  $G = 4$ . We set  $\rho_{i,j} = 0.4$ , when  $i \neq j$ ,  $\rho_{i,j} = 1$  when  $i = j$  for the normalized cross-correlation matrix  $R$  in (13). The power spectral density of baseband white Gaussian ambient channel noise is  $\sigma^2 = 1$ . The block size per coding block  $K = 8$ . The packet size  $n_b = 8000$  bits. The average power level 11.1 watt results in the bit error rate =.002. These value is calculated using equations (17, 26), assuming  $P_1 = P_2 = P_3 = P_4$ . The bridge-close sequence of QCIF format (144x176) is used in our experiments with frame rate 25 fps. The 1024-frame sequence is partitioned into eight GOFs. The modified 3D-SPIHT coder is then applied to the wavelet coefficients to obtain an embedded bitstream. The source bitstream is divided into packets of length 8000 bits. 25 source layers is produced and each layer consists of eight packets so each packet comes from coding one GOF. The following systems are tested:

- 1- Equal error protection (EEP) with 3D-SPIHT.
- 2- Unequal error protection (UEP) with the 3D-SPIHT.
- 3- Unequal error protection with modified 3D-SPIHT (UEP&M-SP).
- 4- Unequal error protection with modified 3D-SPIHT and power optimization (UEP&P).

These systems are evaluated at four transmission rate 20, 25 packets in each one. The end to end MSE is computed by averaging the MSE over each frame of the GOFs, and averaging again over 10 independent transmissions. Figure (5) shows

optimal rate allocation for the exact linear MMSE receiver the average power level is 11.2. Figure (6) shows how power optimization can be used to obtain the optimal quality of video frames that are reconstructed. Figure (7) shows frame number 100 as an example which shows how it suffers from noise.

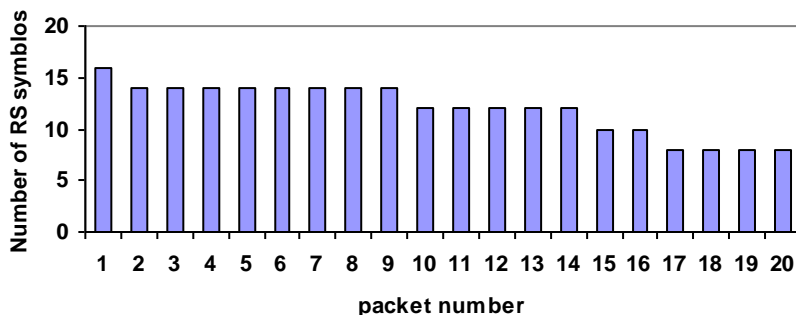

(a) Transmitted layers=20

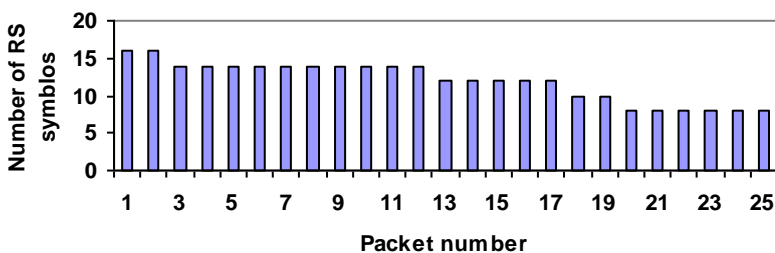

(b) Transmitted layers  $l = 25$

Fig.5. Optimal rate allocation for the exact linear MMSE receiver the average power level is 11.2

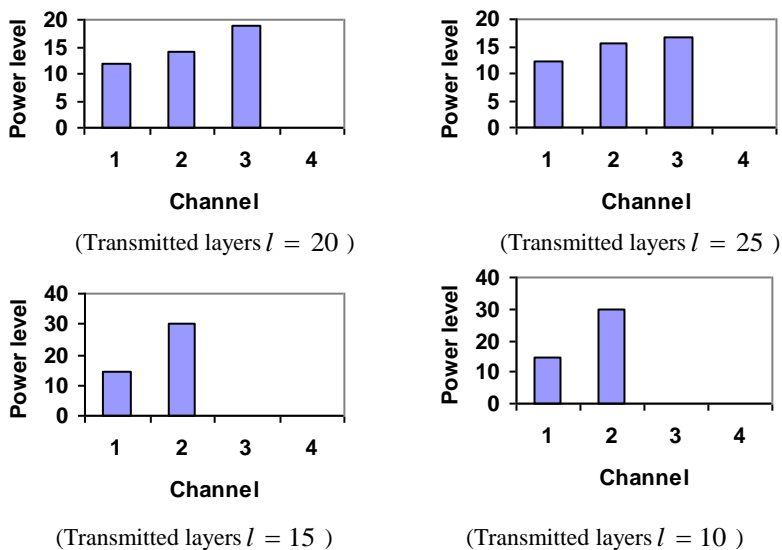

Fig.6. Optimal power allocation for the linear MSEE receiver

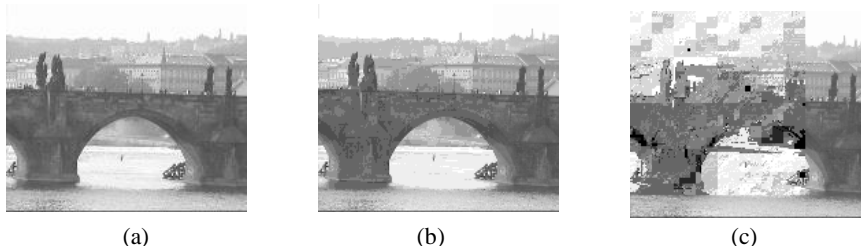

Fig.7. PSNR of frame number 100 (a) original frame, (b) Reconstructed frame (UEP) with PSNR= 30 dB (c) Reconstructed frame (EEP) with PSNR =16.7 dB.

Figure (8) shows superior of our work. Simulation results show that the proposed optimal UEP allocation scheme offers a performance gain of up to 8 dB in PSNR higher than the scheme with EEP equal power levels. Comparing our results with that in [5] shows that our proposal method gives about 6 dB in PSNR for UEP higher than without SPHIT modification. In [5] it provides just 3.5 dB in PSNR for (UEP&P) unequal error protection with power optimization higher than the UEP with equal power. The noticeable observation is that the difference between the EEP and UEP increases as the transmission rate increases. This result is due to the modification of the 3D-SPIHT i.e. if the transmission rate increases there will be a more refinement packets.

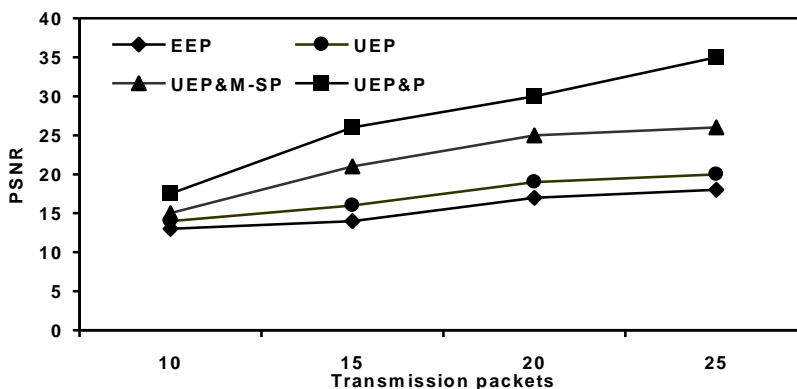

Fig.8. The average PSNR of the decoded video bridge-close as a function of the transmission rate for the RS (EEP & UEP) channel coding.

## 5. CONCLUSION

In this paper, a novel transmission scheme was proposed for the communication of the modified 3D-SPIHT video streams over CDMA channels. The proposed scheme is proposed for rate optimization of channel coding rate allocation at different source layers, and the power allocation at different CDMA channels, to minimize the distortion on the received video data. The proposed method of optimal FEC gives up to 6dB in PSNR higher than the scheme with optimal FEC without 3D-SPIHT modification. The proposed scheme provides significantly better PSNR performance in comparison to the well-known coding schemes.

## REFERENCES

1. B.-J. Kim and W. A. Pearlman, "An embedded video coder using three dimensional set partitioning in hierarchical trees (SPIHT)," in Proc. IEEE Data Compression Conference, Mar. 1997, pp. 251–260.
2. A. Said and W. A. Pearlman, "A new, fast and efficient image codec based on set partitioning in hierarchical trees," IEEE Trans. Circ. and System. for Video Technology, vol. 6, pp. 243–250, June 1996.
3. J. Xu, Z. Xiong, S. Li, and Y.-Q. Zhang, "3-D embedded subband coding with optimal truncation (3-D ESCOT)," Applied and Computational Harmonics Analysis 10, 290-315, 2001.
4. Raymond Steele--Chin-Chun Lee-Peter Gould "GSM, CDMA one and 3G Systems". JOHN WILEY & SONS, LTD 2001.
5. S.Zhao, Z. Xiong, "Joint error control and power allocation for video transmission over CDMA networks with multiuser detection," IEEE trans. Circuits and Systems for Video Tech., vol. 12, no.6, pp. 425-437, June 2002.
6. S. Lin and D.J. Costello, Error Control Coding: Fundamentals and Applications. Englewood Cliffs, NJ: Prentice-Hall, 1983
7. Odenwalder, J.P., "Error control coding handbook" linkabit corporation ,san Diego, A ,July 15,1976.
8. A. Host-Madsen and X. Wang, "Performance of blind and group-blind multi-user detectors," IEEE Trans. Information Theory, vol. 48, no. 7, pp. 1849-1872, July 2002.
9. A. Host-Madsen and X. Wang, "Performance of subspace-based multi-user detection," in Proc. ISIT'01, Washington, DC, June 2001.
10. A. Host-Madsen and X. Wang, "Performance analysis of subspace-based blind and group-blind multi-user detection," in Proc. ISITA'00, Honolulu, HI, November 2000
11. A. Host-Madsen and X. Wang, "Performance of blind multi-user detectors," in Proc. 38th Annual Alperon Conference on Communications, Control and Computing, Monticello, IL, October 2000.
12. H.V. Poor and S. Verdu "Probability of error in MMSE multiuser detection" IEEE Trans. Inform .Theory, Vol..43, pp.677-691, March 1998.
13. X.Wange and H.Poor"Blind multiuser detection: A subspace approach "IEEE Trans. information Theory, vol. 44, pp.677-691, March 1998.
14. R. Fletcher, Practical Methods of Optimization, 2nd ed., New York: Wiley, 1987

## طريقه فعاله لتوزيع معدل النبضات فى نقل الصور عبر القنوات الرقمية المتماثلة

فى هذه المقالة تم تقديم طريقه جديدة و فعالة لنقل اشارات الفيديو المضغوطة بنظام 3D-SPIHT عبر قنوات CDMA . الفكرة الأساسية لهذه الطريقة تعتمد على تصنيف النبضات أثناء عملية التشفير بطريقة 3D-SPIHT تبعاً لأهميتها بالنسبة للإشارة المسترجعة. لقد تم تعديل الطريقة الشهيرة 3D-SPIHT لتنتج نبضات مرتبه تنازلياً حسب أهمية هذه النبضات وللحصول على ذلك تم تقسيم النبضات الكلية الى ثلاث مجموعات و إرسالها تنابعياً . و لمعرفة كفاءة هذه الطريقة فى نقل الصور عبر قنوات CDMA ثم عمل حماية للنبضات المرسله بطريق RS و إرسال النبضات بعد ذلك فى وسط به نسبة خطأ ثم استرجاع الإشارة. وقد أثبتت هذه الطريقة إنها افضل من معظم الطرق القديمة والمعروفة فى كفاءة الأسترجاع للصور.