

DESIGN OF DOMESTIC OIL SHALE FURNACE SYSTEM

Mohammed Awwad Al-Dabbas

Assistance professor, Mechanical Engineering department, Mutah University, Karak, Jordan.

madabbas@mutah.edu.jo, madabbas@yahoo.com

(Received February 20, 2010 Accepted March 31, 2010).

Furnaces of steel sheet combustion chamber were designed, constructed and operated to burn oil shale. The constructed combustion chamber was operated satisfactorily for several hours of operation.

The experiments were conducted at steady state conditions using different values of air fuel ratios. High combustion efficiencies were achieved at various operating condition. The combustion efficiency was noticed to increase with the increase of air to fuel ratio for each test. Carbon monoxide concentration in flue gas was found to decrease with the increase in air fuel ratio. This was associated with the decrease in oxygen gas and an increase in carbon dioxide.

During experimental work chromel-alumel thermocouples were used to measure the temperature distribution within the flame. Exhaust gases were analyzed using (motor scan gas analyzer 8070).

Concentrations of CO, CO₂ and O₂ in the flue gas were measured under various operating conditions. Carbon residue after burning was collected and analyzed.

KEYWORD: oil shale, furnace, gas emission, temperature distribution, factor of safety, domestic, combustion efficiency

NOMENCLATURE

A:	sum of surface area of tube, area of shear, area of surface body of surface, area of surface body of furnace (=5.415 m ²) (m ²)	\dot{m}_f :	mass flow rate of fuel (Kg/s)
A _o :	outside surface area per unit length (m ² /m)	\dot{m}_w :	mass flow rate of water (kg/s)
A _i :	inside surface area per unit length (m ² /m)	\dot{m}_r :	mass flow rate of ash (kg/s)
A _m :	log mean area of tube [= 0.5 (A _o +A _i)] (m ²)	Q _R :	the load input in furnace (kW)
b:	width (m)	t:	thickness of tubes (m)
C _{o2} :	percentage of carbon in flue gases (=8.62%)	T _s :	surface temperature of furnace (=558 °C)
C _v :	calorific value of oil shale (kJ/kg)	(T _o -T _i):	difference between outlet and inlet temperature for flue gases (°C)
		(T _o -T _i):	water temperature different between outlet & inlet to the boiler
		T _o :	temperature of out air (= 20 °C)

d:	welded fitting (m)	T_s :	absolute surface temperature of furnace (K)
E:	modulus of elasticity	T_o :	the temperature outlet of the heat exchanger ($^{\circ}\text{C}$)
h:	the leg size (m)	T_i :	the temperature inlet to the heat exchanger ($^{\circ}\text{C}$)
h:	heat transfer coefficient (= 15 $\text{W}/\text{m}^2.\text{K}$)	U:	the overall heat transfer coefficient ($\text{W}/\text{m}^2.\text{K}$)
h_i :	heat transfer coefficient inside tubes ($\text{W}/\text{m}^2.\text{ }^{\circ}\text{C}$)	U:	internal energy of ash ($\text{W}/\text{m}^2.\text{K}$)
h_o :	heat transfer coefficient of fluid outside tubes ($\text{W}/\text{m}^2.\text{ }^{\circ}\text{C}$)	V:	shear force (N)
$h_{out, in}$:	Enthalpy outlet at inlet temperature of water (kJ/kg)	\bar{v} :	average velocity (m/s)
K:	coefficient for emission from solid fuel (= 0.002)	ε :	strain
k:	thermal conductivity of tube material ($\text{W}/\text{m}.\text{K}$)	α :	specific thermal expansion
\dot{m}	mass flow rate of flue gases (kg/s)	ε :	emissivity of the surface (1 for black body)
		ρ :	the density of flue gas (kg/m^3)

INTRODUCTION

Jordan's energy sector will go under major modernization in the coming 10-15 years, with the approval of Jordan's Energy Master Plan by the cabinet, which will inject about \$3 billion of public and private sector capital [1-6].

This plan will cover all the activities of the sector from the exploitations of natural resources to electricity tariff levels, including energy demand, power sector development, gas distribution, oil refining and renewable energy and especially oil shale

Oil shale as shown in figure 2 is diverse fine-grained rocks, which contain refractory organic material that can be refined into fuels. Soluble bitumen fraction constitutes about 20% of this organic material, whereas the remainder exists as an insoluble kerogen. All oil shale appear to have been deposited in shallow lakes, marshes, or seas, which supported a dense algal biota. The latter was a probable source for the shale-bound organic fuel precursors.

Oil shale is considered mainly as a source of raw material of fossil origin for energy production having a high content of ballast material, this being the reason why oil shale has seldom been employed as an alternative fuel in the past.

Figure 5 shows oil shale locations in Jordan, while table 2 shows the major mineral components of the Jordanian oil shale:

The following are the main localities of oil shale (Fig. 1):

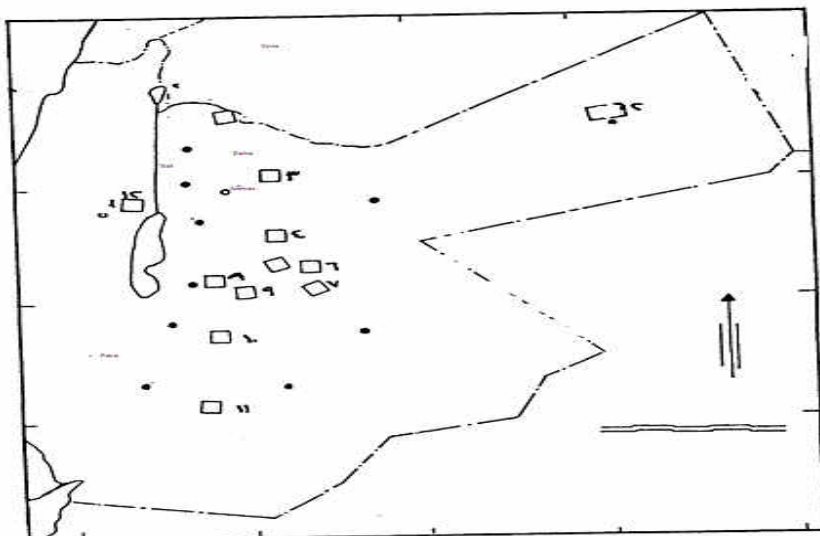

- | | |
|---------------------|--|
| 1. wadi arab | 2. Risha |
| 3. East of Zarka | 4. G. Khan EZ- Zabib of Siwaqa deposit |
| 5. F. Siwaqa | 6. Attarat Umm Ghudran |
| 7. Wadi El – Maghar | 8. El – Lajjun, |
| 9. B. Sultani | 10. Jurf Ed- Darawish |

Figure 1: Oil shale location in Jordan.

A representative sample of El-Sultani oil shale deposit was provided by Ministry of Energy in Jordan. The approximate and ultimate analyses of the oil shale are given in table 2, and 3. The total oil percent was determined following the Fischer assay method. The calorific value was obtained by using Bomb Calorimeter

Table 1: The major mineral components of the Jordanian oil shale

Silica	SiO ₂	15.1
Titanium oxide	TiO ₂	0.2
Aluminum oxide	Al ₂ O ₃	2.64
Iron oxide	Fe ₂ O ₃	1.2
Magnesium oxide	MgO	1.46
Calcium oxide	CaO	32
Sodium oxide	Na ₂ O	0.07
Carbon dioxide	CO ₂	0.06
Carbonate	CO ₃	15-20
Phosphorus oxide	P ₂ O ₅	2.24
sulfur	S	2-3
Organic matter	Organic Matter	25
Ash	Ash	55
Humidity	H ₂ O	4
Carbon dioxide (After burning)	CO ₂	19
Hydrogen	H ₂	1.6
Oxygen	O ₂	1.9

Table 2: Properties of El-Sultani oil shale

Proximate analysis, wt% (as received)	
Moisture	0.46
Ash	57.49
Volatile matter	41.2
Fixed carbon	0.85
Total =100%	
Ultimate analysis, wt% (as received)	
Ash	61.78
Fixed carbon	0.85
Organic carbon wt	14.91
Inorganic carbon	3.81
Hydrogen	1.93
Sulfur	3.66
CO ₂ , wt %	14.11
Total =100%	
Total oil wt%	12.6
Particle density, kg/m ³	1800.0
Heating value, kJ/kg	7327.0

Figures (2-4) show photographic of oil shale deposits in Jordan as shows in figures (6-10).

**Figure 2: Open-pit in Sultani Deposit**



Figure 3: Over burden section of Lajjun



Figure 4: General view of EILajjun

OIL SHALE APPLICATION

Oil shale can be used for several purposes: to obtain heat by direct combustion (for example, in the generation of electricity); to produce shale oil (SO); and as a source of other valuable chemicals. For example, from 1 tone of Estonian oil shale it is possible to produce 850kWh of electricity or 125kg of shale oil (39 800 kJ/kg) and 35 m³ of retort gas (46 800kJ/m³). The efficiency of new FBC (fluidized bed combustion) boilers is on the same level as has been reached in the best condensation atmospheric pressure power plants based on the combustion of coal – 35-36% (net).

Oil shale in Jordan:

The thermal processing of oil shale to oil has quite a long history and various facilities and technologies have been used as shown in figure 5 and figure 6. In principle, there are two ways of the thermal processing:

- low-temperature processing by heating the oil shale up to about 500°C – semi-coking or retorting.
- high-temperature processing by heating up to 1000°C -1200°C – coking.

The technology of processing oil shale:

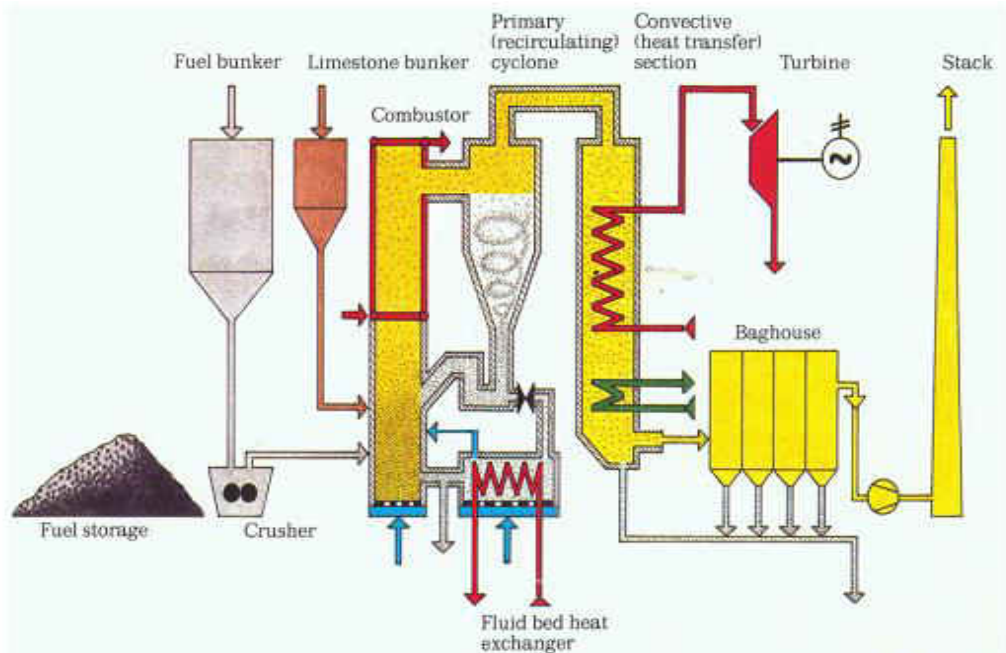

Figure 5 : fluidized bed system for oil shale burning

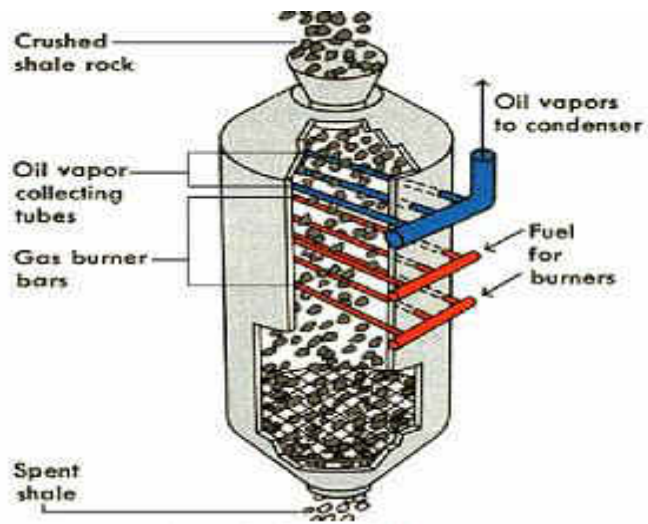

Figure 6: Oil Shale retorting system

Although Jordanian oil shale was used already during the World War1, intensive exploration of the Jordan's oil shale took place only in the 1970s and 1980s. As of 2008, there is no oil shale industry in Jordan; however, several companies are planning to start shale oil extraction as also oil shale combustion for a power generation.

- The Jordanian oil shale is marinated of Late to early Tertiary age. It is typically brown, gray, or black and weather to a light bluish-gray.
- In general Jordanian oil shale is high quality comparable to the western United States oil shale, although their sulfur content is usually high.
- While the sulfur content of the most of oil shale in Jordan varies from 0.3 to 4.3% and the Sultani deposits have sulfur content of 8 to 10%.
- Sulfur is mostly associated with the organic matter with minor occurrence as pyrite.

Water Tube Furnace Design

A water-tube boiler is a type of boiler in which water circulates in tubes heated externally by the fire as shown in figure1 3. Water-tube boilers are used for high-pressure boilers. Fuel is burned inside the furnace, creating hot gas which heats up water in the tubes. In smaller boilers, additional generating tubes are separate in the furnace, while larger utility boilers rely on the water-filled tubes that make up the walls of the furnace to heat water.



Figure 7: water-tube boiler

System Analysis

Figure 14 shows schematic diagram of residence, the heat load characteristic of this residence are:

- Total area=130 m²
- The total heat loss from all room in residence = 10.9KW

- Load for furnace= 10.9KW at least
- Take safety factors 10% for emergency
- The furnace is designed for the domestic hot water.

Design Requirements:

Figure 8 shows the three side view of water –tube network inside the furnace.

1) Dimension :

- **Furnace:** depth = 100 cm , $D_{\text{chimney}} = 16.7 \text{ cm}$
 Width = 100 cm
 Height = 100 cm

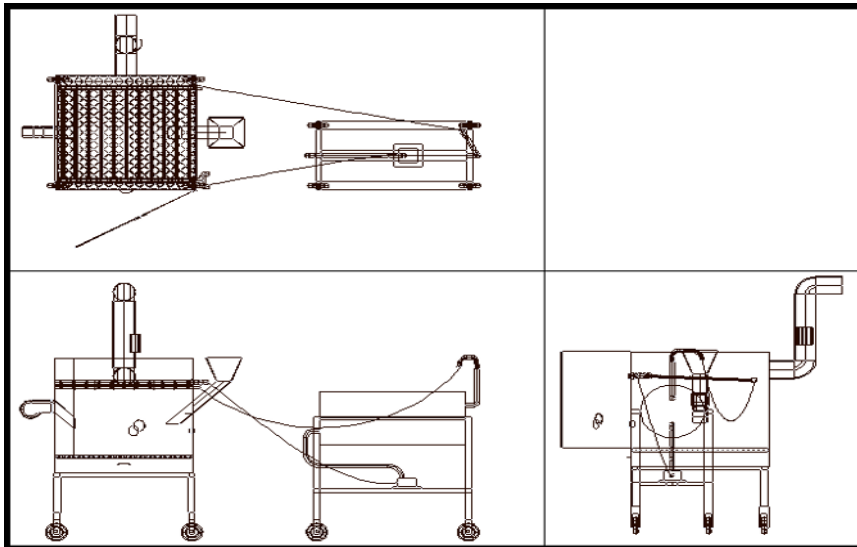

Figure 1 8: Three side view of furnace.

➤ **Water Tube Network :**

Figure 9 shows the water tube network dimensions.

Two tube (1.5 inch) , length = 100 cm

Eleven tube (0.75 inch) , length = 75 cm

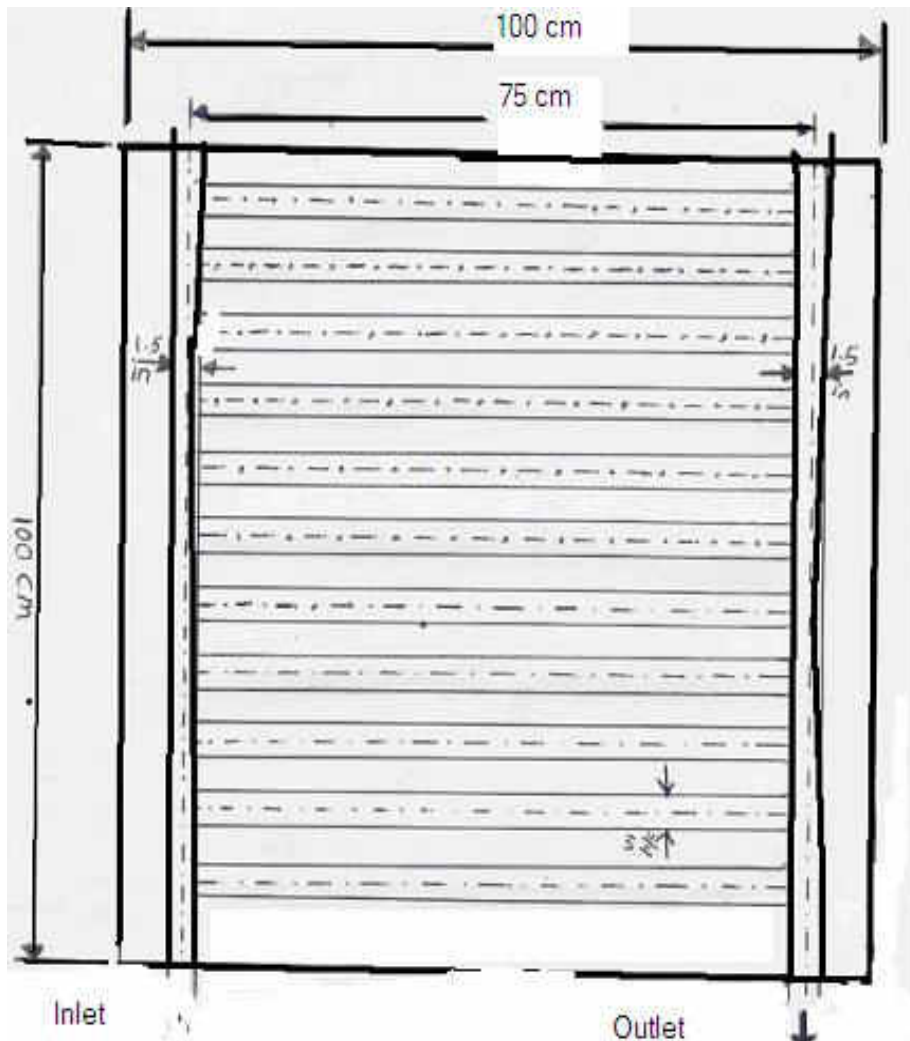

Figure 9: Water tube network.

2) **kind of material :** steel (cover and frame)

➤ The furnace after manufacturing and design is shown in figure 10.



Figure 10: the furnace after built and manufactured

RESULTS AND DISCUSSION:

Temperature Measurement

Tubes are mounted on the flame combustor tube through the water jacket in three different location of the combustor rig, the first tubes are located at 12.5 cm from the nozzle tip, it was used to measure the temperature distribution along the vertical axis of the flame, the second tube located at 37.5 cm from the nozzle tip, it was used to measure the temperature along the axis of the flame, and the third tube located at 37.5 cm from the nozzle tip in a vertical U-tube, for gas sampling.

Five Chromel-Alumel thermocouples were used to measure the temperature of the flame along the axis of the nozzle tip, while the number of thermocouples used to measure the temperature of the flame along the vertical of the nozzle tip were four. These thermocouples are distributed uniformly at equal spaces.

The thermocouples are externally connected to digital microprocessor to read the flame temperature directly. Tables (3-5) show the oil shale reading (temperature, gas emissions). While figures 19, 20 show the Figure 10: relation between temperature & air-fuel ratio.

Table 3: Oil shale reading

Mass flow rate (kg/s)	Time (min)	Temperature Water in C°	Temperature Water out C°	Temperature Furnace C°
0.003	15	20	49	396
0.003	15	33	62	470
0.003	15	41	86	581
0.003	15	71	95	650

Table 4: Oil shale reading

Mass flow rate (kg/s)	Time (min)	Temperature Water in C°	Temperature Water out C°	Temperature Furnace C°
0.003	15	20	31	236
0.003	15	25	43	316
0.003	15	37	74	570
0.003	15	65	82	640

Table 5: Oil shale reading

Mass flow rate (kg/s)	Time (min)	Temperature Water in C°	Temperature Water out C°	Temperature Furnace C°
0.003	15	20	46	390
0.003	15	35	67	475
0.003	15	60	88	573
0.003	15	74	98	645

Gas Analyses

Figure 9 shows the gas Analyzer that used to measure gas flue emission in the furnace.



Figure 11: The Analyses gas which measure gas emission in the furnace.

Components of Flue Gas:

The components of flue gas are listed below in the order of concentration in the gas.

- 1) Nitrogen (N)
- 2) Carbon dioxide (CO_2)
- 3) Water vapor (Humidity).
- 4) Oxygen (O)
- 5) Carbon monoxide (CO)
- 6) Nitrogen oxides (NO)
- 7) Sulfur dioxide (SO)
- 8) Unburned Hydrocarbons (HC)

Table 6 show the flue gaseous which measured by gas analyzer at different furnace temperature which shown in figure 11.

Table 6: Emissions of oil shale at different furnace temperature

	Gas Emissions	Temperature of Furnace (C)	Temperature of Chimney (C) (hole @ 2.5m in the chimney)
CO (%)	0.14	600	123
CO ₂ (%)	13.62		
HC (ppm)	104		
O ₂ (%)	-0.08		
NO(ppm)	111		
COcor (%)	1.67		
Lambda	0.821		
CO (%)	0.17	550	129
CO ₂ (%)	16.81		
HC (ppm)	128		
O ₂ (%)	-0.08		
NO(ppm)	134		
COcor (%)	2.35		
Lambda	0.748		
CO (%)	0.11	650	119
CO ₂ (%)	11.43		
HC (ppm)	97		
O ₂ (%)	-0.08		
NO(ppm)	96		
COcor (%)	1.122		
Lambda	0.889		

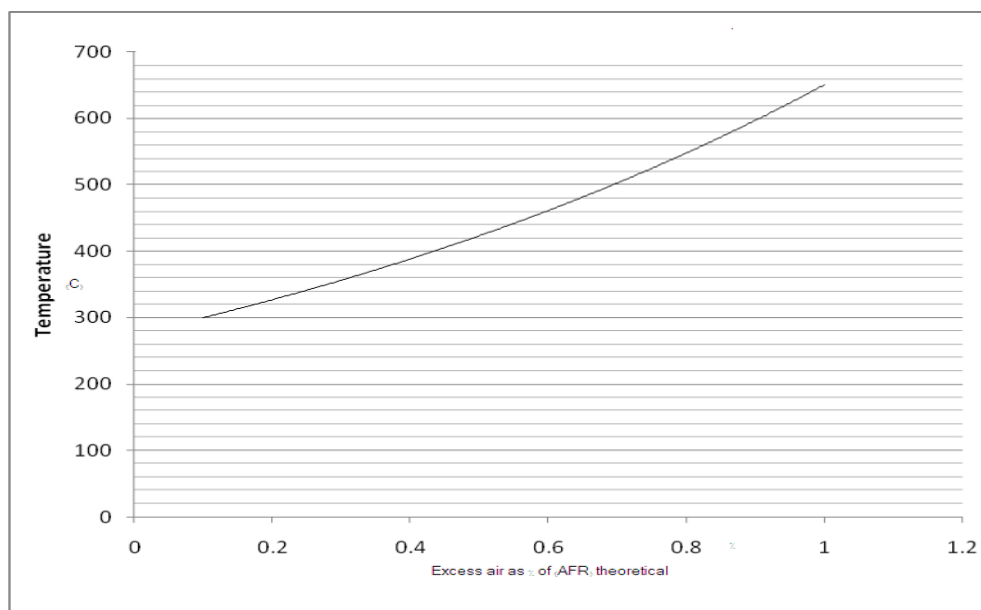

Figure 12: Temperature distribution versus excess air coefficient.

Bed temperature is firstly increased with the increase of air to fuel ratio but at higher values of excess air the trend is inversed and the bed temperature begins to decrease. It is clearly seen that the increase of air to fuel ratio up to 48% (as percentage of theoretical air to fuel ratio) will increase the bed temperature as shown in figure 12. This is due to the increase of air flow, and hence, oxygen gas which in turn increases the mixing of solid fuel. Consequently, the combustion intensity will increase and so the temperature of bed. However, as the air to fuel ratio becomes greater than 48%, the temperature begins to decrease. The reason may be due to the additional flow of cold air which absorbs some heat from the bed. Generally, bed temperatures lie between 550-650°C depending on the air to fuel ratio and fluidization conditions.

CONCLUSIONS

The following may be concluded from the present work:

1. The fluidized bed combustion of El-Sultani oil shale has been experimentally investigated.
2. The results have shown that stable oil shale combustion was sustained without external energy. Steady state combustion was ensured via constant readings of temperatures through the bed.
3. High combustion efficiencies were obtained. The combustion efficiency was increased with the increase of air to fuel ratio
4. Concentration of carbon monoxide in flue gas was decreased with the increase of air to fuel ratio, while the concentration of CO₂ was increased.
5. The temperature in the boiler reached to (650°C) when the oil shale is burned
6. The temperature in water storage tank reaches to (95 °C)

7. The incomplete combustion loss was very low.
8. With the experimental matrix used, oil shale has almost negligible effect on the emission of carbon oxides (CO_x).
9. The proportion of sulfur dioxide emitted between 10-200 ppm due to the fact that 90% of SO_2 be contained through calcium carbonate.
10. The values of nitrogen monoxide between 96 to 134 ppm.
11. The carbon monoxide emission from chimney was 90 to 50 ppm.
12. The possibility of burning oil shale rock in spite of the presence of (67 -77)% ash and a high percentage of sulfur (3-4)%.

REFERENCES

1. Jordan Electricity Authority, The Investment of Oil Shale by Direct Combustion, Report, Amman, August 1991
2. Hamarneh, Y., 1995. Oil shale origin, composition and methods of utilization. Laboratory directorate- NRA.
3. Ministry of Energy and Mineral Resources, Annual Report, Amman, Jordan, 2007.
4. Ministry of Energy and Mineral Resources, Facts and Figures Amman, Jordan, 2007.
5. Natural Resources Authority, Annual Report Amman, Jordan, 2007.
6. Department of Statistics, Annual Statistical Book, Amman, Jordan, 2007
7. Proceedings of the International Oil Shale Conference Recent Trends in Oil Shale: Research and Applications, Amman, Jordan, 2006.
8. SUNCOR Energy, Presentation about Jordanian Oil Shale Project: Conceptual Design, Amman, Jordan, March 1999.
9. Proceedings of the International Oil Shale Conference Recent Trends in Oil Shale: Research and Applications, Amman, Jordan, 2006.
10. Geology and resources of some world oil-shale deposits. *Scientific Investigations Report* U.S. Department of the Interior. U.S. Geological Survey.(<http://pubs.usgs.gov>).
11. Al-Dabbas Mohammed, Mathematical Modeling of Oil Shale Combustion in Circulating Fluidized Bed Combustor, Ph.D. Thesis, University of Jordan, Jordan 2002.
12. Al-Dabbas Mohammed, Oil Shale Combustion, M.Sc. dissertation. University of Jordan, Amman, Jordan 1992.
13. Y. Hamarnah, Oil Shale Resources Development in Jordan, updated and revised by J. Alali and S. Sawaqed, 2006, Natural Resources Authority, Amman, Jordan.

Appendix

The design of furnace must has capacity greater than or equal (10.9 KW) to provide heat for (130 m²) residence area.

1) The heating load:

$$Q = U \times A \times (T_o - T_i)$$

➤ To find U:

$$U = \frac{1}{\frac{1}{h_o} + \left(\frac{t \times A_o}{k \times A_m}\right) + \left(\frac{A_o}{h_i \times A_i}\right)}$$

➤ From HVAC table:

$$k=40 \text{ (W/m. } ^\circ\text{C) for steel.}$$

➤ From heat transfer table:

$$h_i \text{ for water at } 80 \text{ } ^\circ\text{C}=3700 \text{ (W/m}^2 \cdot ^\circ\text{C)}$$

$$h_o \text{ for gas at } 650 \text{ } ^\circ\text{C}=1900 \text{ (W/m}^2 \cdot ^\circ\text{C)}$$

➤ Taking

$$T_o=95 \text{ } ^\circ\text{C}$$

$$T_i=20 \text{ } ^\circ\text{C}$$

$$t=5 \times 10^{-3} \text{ (m)}$$

$$A_o=0.8 \text{ (m}^2\text{)}$$

$$A_i=0.129 \text{ (m}^2\text{)}$$

$$U = \frac{1}{(2.7 \times 10^{-4}) + (2.15 \times 10^{-4}) + (3.26 \times 10^{-3})} = 267.022 \text{ (W/m}^2 \cdot \text{C}^\circ\text{)}$$

➤ So the heating load:

$$Q = (267.02) \times (0.8) \times (60) = 12.81 \text{ KW}$$

2) furnace chimney:

The value of the chimney cross-sectional area A, depends on the boiler capacity and its

height, it is calculate by using the following relation:

$$A_c = \frac{m_{gas}}{\rho v}$$

To calculate \dot{m}_g :

$$\dot{m}_{sf} = (3\text{kg}) / (15 \times 60\text{s}) = 0.003 \text{ kg/s}$$

1 kg solid fuel produces 38.4 kg/s gas

0.003 kg solid Fuel produce 0.1152 kg/s gas

$$A_c = (0.1152) / (1.1)(5 \text{ m/s})$$

$$A_c = 0.0209 \text{ m}^2$$

$$D_c = 16.33 \text{ cm}$$

3) Selection of circulating pump for furnace:

$$Q = m c_p (T - T_i), \quad m = \frac{Q}{c_p (T - T_i)}$$

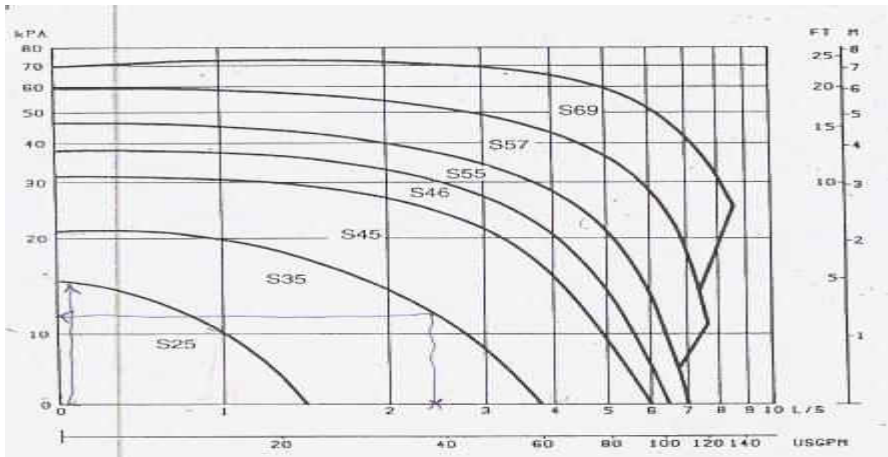

Figure13: Selection of pump.

The pressure drop per unit length:

$$\Delta P = \frac{\Delta H}{EL}$$

To calculate the equivalent length:

- 1) 2*(D=1.5 inch ,L=0.95 m)
- 2) 11*(D=0.75 inch ,L=0.75 m)
- 3) 22 (L_e for 90° Tee main)

$$\sum L = \{(2*0.95) + (11*0.75)\} = 10.15\text{m}$$

$$\sum L_e = (22*1.5) = 33\text{m}$$

$$\sum EL = 10.15 + 33 = 43.15\text{m}$$

$\Delta P = \frac{13000}{43.15} = 301.3 \text{ Pa/m}$ Which is within the design range limits between (200-550) Pa/m as shown in figure 13. Thus, this pump is acceptable.

4) The second efficiency of water tube furnace:

The second law efficiency for devices with no work input or output such as heat exchanger where the heat is transferred from the higher temperature fluid to the lower fluid temperature.

$$\eta = \frac{m_1(\psi_2 - \psi_1)}{m_{21}(\psi_3 - \psi_4)}$$

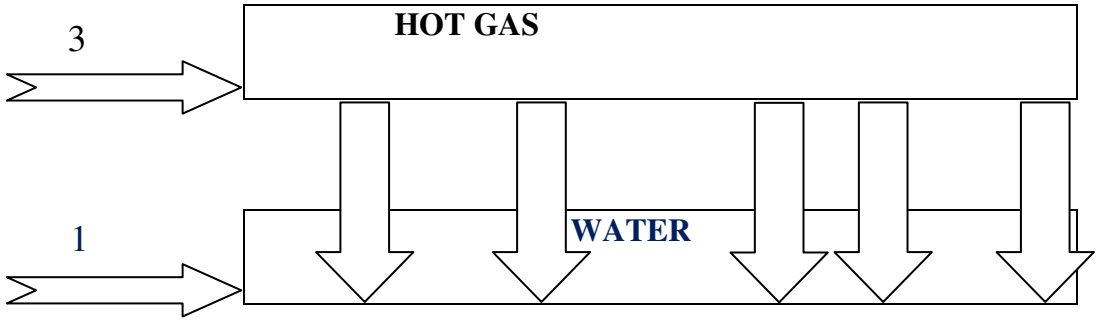

Data given:

$$\dot{m}_g = 0.1152 \text{ Kg/s}$$

$$m_{water} = 0.0433 \text{ Kg/s}$$

$$C_p = 1.09 \frac{\text{Kj}}{\text{Kg.K}} \text{ for flue gas}$$

$T_o = 20 \text{ C}^\circ$ ambient temperature

From thermo dynamics table 7:

Table 7: thermo dynamics table.

Temperature	20	95	650	190
enthalpy Kj/Kg	$h_1 = 83.94$	$h_2 = 397.44$	$h_3 = 989.94$	$h_4 = 462.34$

$T_1 = 20 \text{ C}^\circ$	Entropy $S_1 = 0.296 \text{ Kj/Kg.k}$
	Entropy $S_2 = 1.25 \text{ Kj/Kg.K}$

$$\psi_2 - \psi_1 = (h_2 - h_1) - T(S_2 - S_1)$$

$$= 125.08 \text{ Kj/Kg}$$

$$\psi_3 - \psi_4 = (h_3 - h_4) - T(S_3 - S_4)$$

$$\frac{m(\dot{prod})}{\dot{m}_{water}} (\psi_3 - \psi_4) = \frac{m(\dot{prod})}{\dot{m}_{water}} \{C_p(T_3 - T_4) - T(C_p \ln \frac{T_3}{T_4})\}$$

$$= 173.56 \text{ Kj/Kg}$$

$$\eta = \frac{125.08}{173.56} = 72\%$$

5) Heat reject from solid fuel:

$$Q_R = \dot{m} \times C_v = 0.003 \times 7327 = 22 \text{ KW}$$

6) Heat added to water:

$$Q_A = \dot{m} \times (h_{o,\text{at } 95\text{ C}^\circ} - h_{i,\text{at } 20\text{ C}^\circ}) = 0,0433(397.61 - 83.94) \\ = 13.58 \text{ KW}$$

7) Heat loss from furnace:

Figure 14 shows the heat loss from furnace.

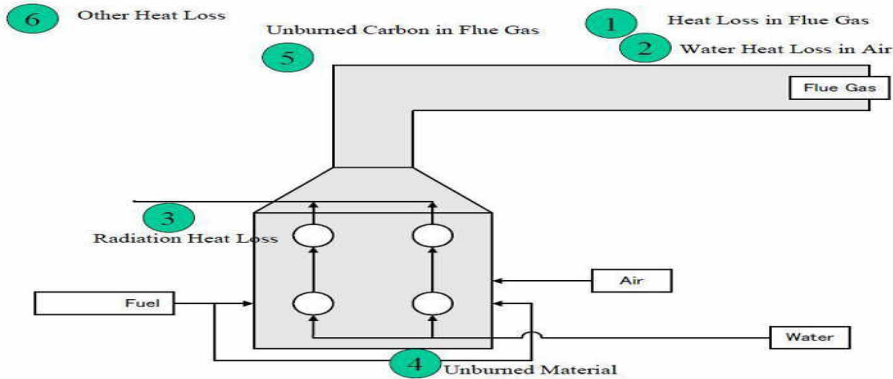

Figure 14: Heat loss from furnace.

➤ Flue gases:

$$Q = k \times \frac{T_o - T_i}{C_{o_2} \%} \times Q_i$$

$$Q = 0.505 \text{ KW}$$

Q_R : the load input in furnace = 22KW

➤ Radiation around the furnace:

$$Q = \epsilon \times A \times \sigma \times (T_s^4)$$

One side $A = L \times W = 0.95 \times 0.95 = 0.9025 \text{ m}^2$

All side $= 6 \times 0.9025 = 5.415 \text{ m}^2$

$\sigma = 5.67 \times 10^{-8} \text{ w/m}^2 \cdot \text{K}^4$

T_s = absolute surface temperature of furnace = $558 + 273 = 831 \text{ K}$

$$Q = 1 \times 5.415 \times 5.67 \times 10^{-8} \times (831)^4 = 144.15 \text{ W}$$

➤ Convection from surface around furnace:

$$Q = h \times A \times (h_o - h_i)$$

Where:

A: area of surface body of furnace = (5.415 m^2)

h: heat transfer coefficient = $(15 \text{ W/m}^2 \cdot \text{C}^\circ)$

T_s : surface temperature of furnace = 558 C° .

T_o : temperature of out air = 20 C° .

$Q = 5.415 \times 15 \times (558 - 20) =$

$Q = 43.69 \text{ W}$

➤ HEAT LOSS BY REFUSE ASH:

$$Q = \dot{m}_s \times U$$

$$Q = (0.001 \times 5423.212) = 5.423 \text{ KW}$$

تصميم حارقة للصخر الزيتي للاستخدام المنزلي

تم تصميم وبناء فرن لحرق الصخر الزيتي. حيث تم تشغيل هذا الفرن لساعات متواصلة دون حدوث مشاكل فنيه. وكانت النتائج مرضية والتي تمت في ظروف احتراق ثابتة باستخدام قيم مختلفة من الهواء ووقود الصخر الزيتي

لوحظ ان كفاءة الاحتراق تزداد مع زيادة نسبة الهواء إلى الوقود وبالمقابل انخفض تركيز أول أكسيد الكربون من الغاز العادم

وقد ترافق ذلك مع انخفاض في غاز الأوكسجين وزيادة ثاني أكسيد الكربون. أثناء العمل التجريبي تم استخدام مجسات الكرومل / ألومنيوم لقياس درجات الحرارة الشعلة وغاز العادم , وكذلك تم استخدام جهاز تحليل الغازات الخارجة من العادم وهي : أول أكسيد الكربون, ثاني أكسيد الكربون, الأوكسجين