



Position control of a pneumatic cylinder actuator using modified PWM algorithm

Original
Article

Moataz A. Youssry¹, Wael M. Elmayyah², Mohamed Hussien Mabrouk³

¹Egyptian armed forces and ^{2,3}Military Technical College

Keywords:

Dead-zone compensator, non-linearity, pneumatic double acting cylinder, solenoid DCV.

Corresponding Author:

Mohamed Hussien Mabrouk, Military Technical College, Cairo, Egypt,
Tel: +201011345207. Email: mmabrouk@mtc.edu.eg.

Abstract

Pneumatic cylinders are used as actuators for modern automated systems in many industries applications for their numerous advantages. Basically, those applications are implemented using components such as proportional and servo pneumatic control valves that are relatively expensive because of their high accuracy even in applications that do not require such high accuracy. Recently, binary (on/off) solenoid directional control valves (DCVs) have been used to replace many of the expensive components and consequently reduce the system cost with achieving acceptable accuracy. This paper presents a control technique for a positioning system of a pneumatic double acting cylinder controlled by pair of on/off solenoid DCVs. The control technique has been developed based on a parametric study presented previously by the authors^[1]. The control technique depends on operating the DCVs using a pulse width modulation (PWM) algorithm that is modified to employ a valve dead-zone compensator (DZC) along with using optimum pneumatic parameters gained from the performed parametric study. An experimental test bed for a pneumatic double acting cylinder positioning system that uses a pair of on/off solenoid DCVs has been installed to test the accuracy of the presented control technique. A comparison between the performance of the positioning control technique using the modified PWM control algorithm and the traditional one has been carried out to experimentally show the enhancement of the positioning accuracy with acceptable maximum steady state error less than 0.7 mm when using the modified PWM control technique due to reducing the system nonlinearity associated with its dynamics.

I. INTRODUCTION

Over the last decades, the utilization of pneumatic systems in industrial applications has risen for their many advantages. Pneumatic systems are effective, environment-friendly, durable, reliable, and highly adaptable to harsh operation environment as they are less affected by high temperature, dust, corrosion, and other environmental conditions^[2]. In order to achieve tasks that involve positioning control with acceptable accuracy, servo and proportional valves are used with appropriate control methods. However, this causes losing of the economical advantage of using pneumatic systems due to the high cost of most of the pneumatic system components^[3].

Lately, researchers attempt to cut down the cost of the servo-pneumatic systems by designing economical systems with satisfactory accuracy. Binary (on/off) low cost directional control valves are used in pneumatic positioning systems instead of expensive servo and proportional valves. However, using such valves increases

the nonlinearities of the system as the output has basically only two states^[2]. In order to decrease some of the systems' nonlinearities, which appear in form of hysteresis, most researchers used pulse width modulation signals to operate solenoid DCVs^[3].

The dynamic behaviour of solenoid DCVs and pneumatic actuators under the operation of PWM signal has been investigated in many researches^[4-7] that leads to the determination of the solenoid valves dead-zone in which the valve output (O/P) is obscured for certain range of the PWM input (I/P) signal. Many operating schemes have been developed to eliminate or minimize the dead-zone region of solenoid valves^[10]. In most of the aforementioned researches, the system behaviour and positioning control accuracy were enhanced using sophisticated control methods and algorithms, which were implemented using high to moderate cost controllers.

The key point in this paper is to present the development of positioning control technique for a pneumatic double acting cylinder that is used in an economical pneumatic

system employed in the field of cloth printing. The work presented in this paper is considered as an extension of the parametric study presented by the authors in^[1] for this economical industrial system. The presented control technique depends on modifying a PWM control algorithm via using optimum pneumatic parameters obtained from the performed parametric study.

The details of the system, the experimental test rig description, and system circuit diagram are presented in section 2 of this paper while section 3 reviews a glance of the system mathematical model and the parametric study main results. The design of the modified PWM control technique for this system is explained in details in section 4. Results, data analysis and discussion which emphasize the importance of reducing the system nonlinearities and its influence on the system accuracy is presented in section 5.

II. EXPERIMENTAL SETUP AND SYSTEM DESCRIPTION

The experimental test rig for the pneumatic system considered in this study is installed in the fluid control

laboratory, Military Technical College, as shown in figure 1. It can be seen that the system main constituents are the actuator which is a double acting cylinder with 125 mm stroke length and the rod diameter is 25 mm. The linear motion of the piston is controlled by two commercial solenoid internally actuated pilot 3/2 pneumatic DCV. A linear variable differential transducer (LVDT) WA100 is used to measure the position of the piston. The LVDT has sensitivity of 80mV/V and a carrier frequency of 4.8kHz.

Two programmable Parker pressure transducers (SCPSD-016-14-15) are used to monitor the pressure in each chamber of the cylinder with output accuracy of $\pm 0.5\%$ from the full scale of 16 bar. Another pressure transducer (PES-110) is used to monitor the supply air pressure with accuracy of $\pm 0.5\%$ from the full scale of 16 bar. A data acquisition card (DAQ); (NI- PCI-6033E) is used for acquiring the sensors data with sample rate of 10 kHz and number of bits of 16. Recommended by the results of the parametric study of the system^[1], an accumulator is used to the rod side chamber to decrease the nonlinearity associated with the backpressure. The system schematic diagram is illustrated in figure 2.

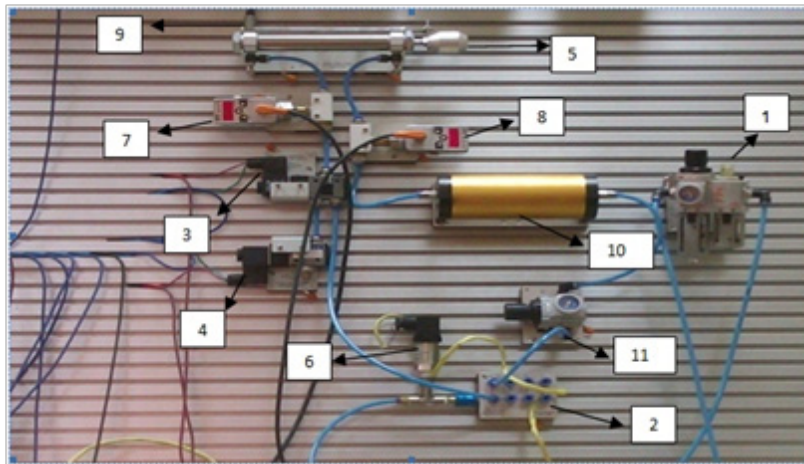

Fig. 1: Experimental pneumatic circuit used to test the modified PWM controller 1-Air preparation unit, 2-Air distributing unit, 3, 4- 3/2 Solenoid DCV, 5-Double acting pneumatic cylinder, 6-Pressure transducer no.1, 7-Pressure transducer no.2, 8- Pressure transducer no.3, 9-LVDT, 10-Accumulator, 11-Pressure regulator.

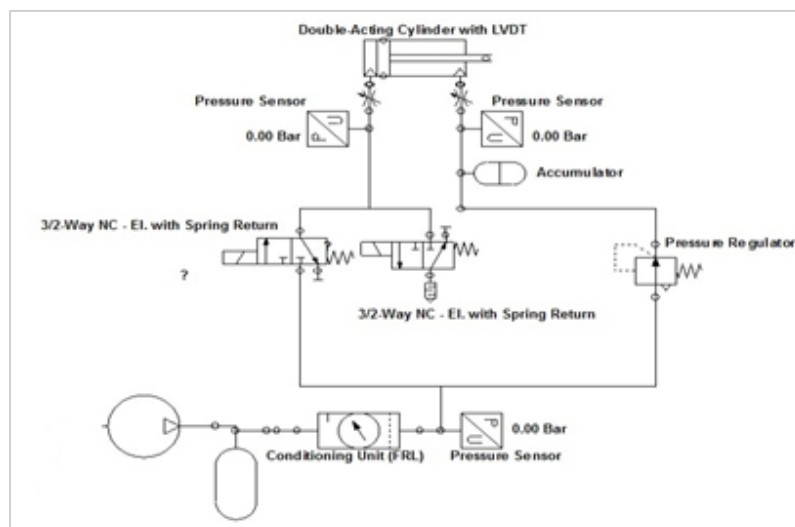

Fig. 2: Pneumatic circuit diagram

III. MODELING OF THE PNEUMATIC SYSTEM

In order to enhance the pneumatic systems performance, a better understanding of the system behaviour through mathematical modeling and simulation is needed. Matlab® Simscape has been used by many researchers as it offers advanced and easy solutions to model and simulate pneumatic systems^[8-10].

Adopting the approach of physical network modeling technique followed by many researches^[11-15], the dynamic equations for the pneumatic system in this research have been modeled and simulated using Matlab® Simscape toolboxes and discussed in details in^[1]. The model has been validated by comparing the predicted dynamic behaviour of the system to the experimentally measured one. A parametric study has been performed to understand the dynamic system behavior, determine the major affecting parameters, and configure the optimum operating PWM frequency suitable for supply pressure and the corresponding effective duty cycle range.

The parametric study presented in^[1] has shown that throttling the air flow to the cylinder inlet by adding a small orifice (with area of 1e-6 m² and discharge coefficient of 0.8) decreases the nonlinear effect of the air compressibility on the piston side pressure by about 80%. However, the velocity of the piston is increased by about 130% at the recommended working supply pressure, which ranges from 2.5 to 4 bar, and consequently the pneumatic system loses the high speed utility. In addition, the parametric study has shown that using an accumulator of 1-liter volume and pressure of 1 bar to the rod side chamber tends to decrease the backpressure nonlinearity for no less than 50%.

Using a constant dead weight at rod-side would have been a simple choice to maintain a constant force at rod-side, however, the benefit of using the accumulator is to maintain a constant pressure difference between both cylinder's sides at constant load with no sudden pressure change. In addition, using a pressure regulator facilitates investigation of the effect of different accumulator pressures on the positioning accuracy, as recommended in previous studies^[1].

Studying the valve response to PWM input signal has showed that the optimum PWM signal frequency to operate the valve is 20Hz and the corresponding effective range of duty cycle is from 10% to 60% at 4 bar supply pressure.

IV. SYSTEM CONTROL STRATEGY

Previously in^[1], two control methods have been used to perform piston positioning control for the system in this research. The first method is a simple on/off control method (bang-bang control) which has shown an undesirable effect of the DCV delay time on the system response. The traditional PWM based control method has been applied to the system to enhance the dynamic behaviour of the system, make a stable positioning, and to waive the undesired behaviour of the bang-bang control method.

In this paper, the optimum pneumatic parameters

based PWM control technique is developed by modifying the traditional PWM control algorithm to be used with maintaining a constant cylinder outlet pressure by taking advantage of employing a dead-zone compensator (DZC) along with using the optimum pneumatic parameters as recommended by the parametric study performed to the system.

Pneumatic drives are usually controlled by proportional or servo valves for high accuracy of position control. In these valves, continuous varying of the valve flow resistance leads to vary the airflow mass that enters into and out from the actuator^[15]. On/off solenoid DCV is used here to control the varied flow discretely. The airflow enters into or out from the actuator in form of packets. If those packets are delivered faster than the actuator dynamics, the actuator responds negatively to the average mass flow rate that enters into or out from it. The desired PWM signal needed to control the solenoid valves can be realized by comparing the continuous control signal and a high-frequency carrier wave^[8]. The carrier wave is usually a high-frequency tooth wave with a period T. The frequency and amplitude of the carrier wave must vary faster than those of the continuous signal. Following the approach adopted in^[7], the mathematical description of the used PWM signal here can be given by the following equations:

$$U_{PWM}(t) = \begin{cases} U_p & \text{for } V_c(t) \geq V_d(t) \\ 0 & \text{for } V_c(t) < V_d(t) \end{cases} \quad (1)$$

$$V_d(t) = \left[t - (j-1)T \right] \frac{V_p}{T}, \quad \text{for } (j-1)T \leq t < jT, \quad j=1, 2, \dots, n \quad (2)$$

where U_{pwm} is the PWM signal, U_p is the maximum operating voltage, V_c is the voltage of the carrier wave, V_d is the command signal voltage, j is the j^{th} modulation period.

For valves operated by PWM signal, if the PWM frequency is very high, the switching-on time will be less than the valve delay time, so the valve will not respond and stay closed, also if the PWM frequency is too small, the valve will stay off^[8].

This means that the modulating frequency should be selected to ensure the valve opening for certain minimum duty cycle and the range of the effective duty cycle defined to determine the boundary of the valve dead-zone.

Also, it can help in avoiding of nonlinearity^[9, 10]. Figure 3 (left) represents the dead-zone characteristics of a single 3/2 solenoid valve where U_c is the valve input and U_v is the valve output and U_{cm} is the minimum effective valve input and Sv is the slope of output. While figure 3 (right) shows the graphical representation of the lookup table for (DZC). The slope of the compensator output $U_{vc}(e_s)$ and $U_{vc}(e_{Max})$ are obtained using simulation-based tuning. Equation (3) represents the mathematical description of the dead-zone characteristics:

$$U_r(u_c) = \begin{cases} s_r > 0, & u_c > u_{cM} \\ 0 & , & u_c < u_{cM} \end{cases} \quad (3)$$

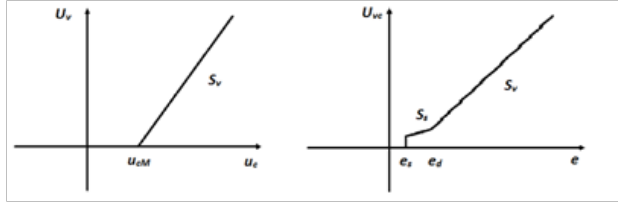

Fig. 3: Dead-zone characteristic (left), Graphical representation of DZC (right).

In order to compensate the valve dead-zone, a dead-zone compensator (DZC) is employed in the modified PWM algorithm. The DZC value is selected according to three conditions:

1. For a position error e equal or less than the desired error e_d , the input signal u_c is zero.
2. For a position error e greater than the desired error e_d , the input signal $u_c > u_{cM}$.
3. For error e where, $e_s \geq e \geq e_d$ the compensator will make output with slope S_s , and this area will be called smoothness area; and the e_s is the error at this regime.

The DZC value is taken into consideration in the control algorithm as a lookup table at the input of each valve where its values are defined from the parametric study results^[1]. The desired positioning error e_d is 0.1 mm corresponding to controller output (Duty cycle) $U_{vc}(e_d) < 12\%$, smoothness area with e_s equal 2 mm, controller output $U_{vc}(e_s) < 20\%$, maximum controller output $U_{vc}(e_{Max}) > 55\%$, and PWM frequency 20 Hz. The presented control algorithm has been developed using Matlab[®] Simulink toolbox and the corresponding systems are implemented using commercial micro controller Arduino board. Figure 4 represents a scheme for the modified PWM algorithm on Matlab[®] Simulink toolbox. The control algorithm is developed with Arduino target toolbox through Simulink[®] environment using the same structure block that is used to build the system model on Simscape[®] environment.

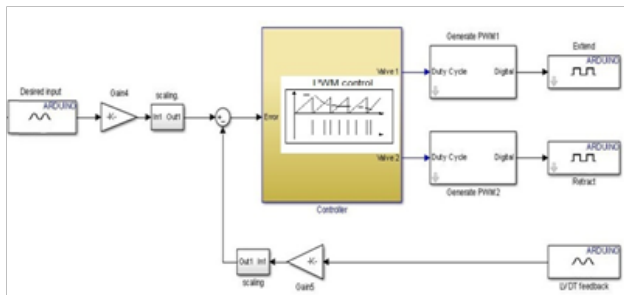

Fig. 4: Matlab[®] Simulink scheme for modified PWM controller

V. DATA ANALYSIS AND DISCUSSION

Figure 5 shows the piston output position at constant backpressure compared to the desired position, while figure 6 shows actuator response vs. pressure response using modified PWM control technique. It can be noticed from figure 6 that adding accumulator at the rod side reduces the backpressure variation (almost 2.5 bar), which in turn reduces the nonlinearity of the system. From figure 7 it can be inferred that steady state error is in range of ± 0.28 mm and mean error 0.43 mm which means that the modified PWM control algorithm provides better position accuracy (with maximum steady state error of 2.5 mm) than that achieved using the conventional PWM algorithm used previously in^[1] for the same system.

From figure (5-7), it can be concluded that this method attains relatively high accuracy but with observable overshoot. However, as the accumulator pressure increases the overshoot decreases but with the increase of the steady state error, as can be noticed from figure 8. This can be probably due to that increasing the accumulator pressure acts as cushion which damps the unexpected variance in motion.

When accumulator pressure increased to (4 bar) the steady state error becomes ± 0.7 mm but with less overshoot and mean error 0.315 mm as illustrated in figure 9.

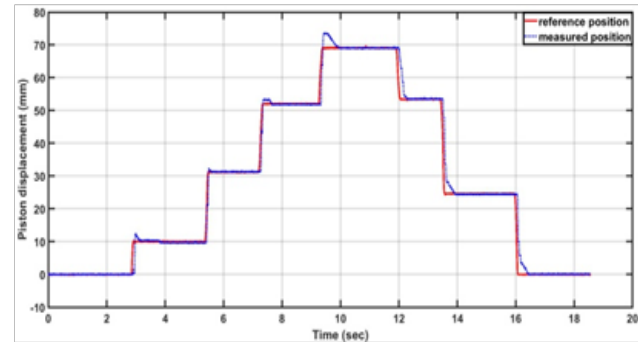

Fig. 5: Actuator response using modified PWM algorithm at $P_{ac} = 2.5$ bar

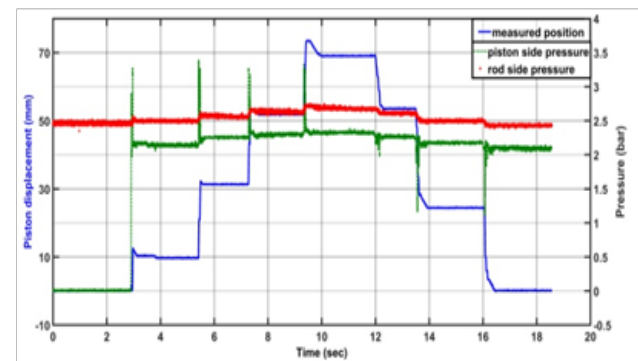

Fig. 6: Actuator response vs. pressure response with modified PWM control algorithm

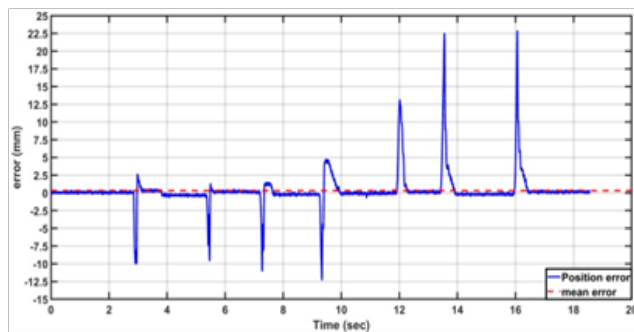

Fig. 7: Position error using modified PWM algorithm at $P_{ac}=2.5$ bar.

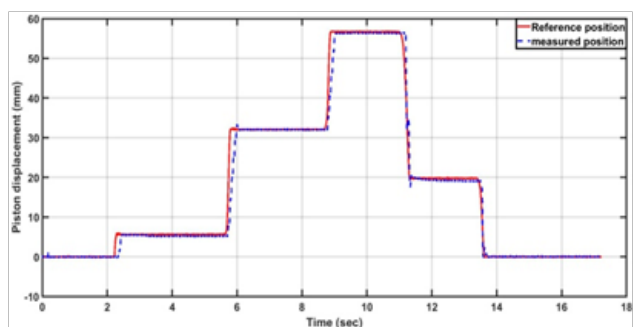

Fig. 8: Actuator response at $P_s=4$ bar and $P_{ac}=4$ bar.

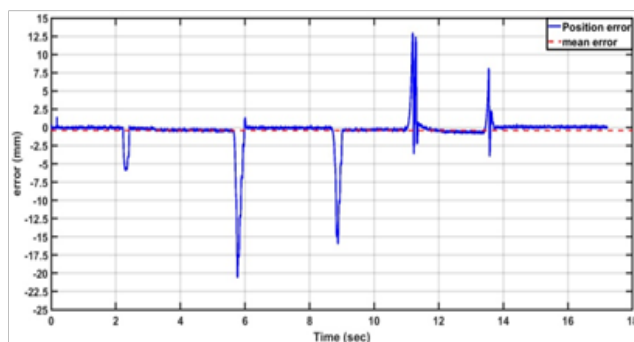

Fig. 9: Position error using modified PWM algorithm at $P_{ac}= 4$ bar.

Discussing the effect of the load value and direction on the system, the piston acceleration is decreased with decreasing the pressure difference among both sides when using a constant load. Consequently, at the same pressure difference the acceleration is decreased further by increasing the load, which results in reducing the error at the expense of speed.

Regarding the load direction, it can be noticed from the results that moving the load against the rod side reduces the overshoot and achieves smooth motion with almost the same accuracy. However, this conclusion needs further investigation in the future to determine the effect of the value of the pressure difference between cylinder sides.

The system nonlinearity has been investigated thoroughly with the conclusion that the nonlinearity appears

in the operation nature of the valve and its characteristics, specially the dead-zone which is reduced by adding dead-zone compensator in the proposed control algorithm^[1, 16].

Operating solenoid valves using PWM signal increases its temperature, and this is a general drawback of using PWM which is a reason of choosing a low-cost solenoid. The variation in the solenoid temperature has not been investigated in this study and can be further investigated in the future.

VI. CONCLUSION

This paper presents a modified PWM positioning control algorithm for a double acting pneumatic cylinder with acceptable accuracy that can be used to aid in replacing of expensive pneumatic constituents by commercially low-cost constituents. The modified PWM control algorithm depends on employing dead-zone compensator along with using the optimum pneumatic parameters values gained from parametric study previous performed on the system^[1] to reduce the system nonlinearity associated with its dynamics. Using the modified PWM control algorithm enhances the performance of the system, which shows good positioning accuracy, where the steady state error is decreased from ± 2.5 mm using traditional PWM control algorithm^[16] to ± 0.28 mm .

The results show that increasing the accumulator pressure enhances the system performance increasing in the system damping characteristics, by 70%, the mean error to as of 27%, and . These results ensure the capability of the presented control method to improve the pneumatic positioning systems performance by reducing system's nonlinearities with less control algorithms complications.

VII. REFERENCES

- [1] Youssry, A., Elmayyah, W., Mabrouk, M., and Mahgoub, M., "Parametric Study Of A Low Cost Pneumatic System Controlled By On/Off Solenoid Valves", IJRET: International Journal of Research in Engineering and Technology, 2016. Vol-05(Iss-03): p. 184-193.
- [2] Mabrouk, M., and Ahmed Y. Abdel-Hamid, "Control of Polar Robot Manipulator Subjected to Harmonic Excitation Using Low Cost Controller," Lecture Notes in Engineering and Computer Science: Proceedings of The World Congress on Engineering 2019, 3-5 July, 2019, London, U.K., pp485-489.
- [3] AbdelHamid, A., AbdelKader, H., and Mabrouk M., "Load Tracking And Anti-Sway Control For Telescopic Rotary Crane", Proceedings of the ASME 2017 International Mechanical Engineering Congress and Exposition, IMECE2017, November 3-9, 2017, Tampa, Florida, USA
- [4] Chavoshian, M., Taghizadeh, M. and Mazare, M., "Hybrid Dynamic Neural Network and PID Control of Pneumatic Artificial Muscle Using the PSO Algorithm", Int. J. Autom. Comput. 17, 428-438, 2020. <https://doi.org/10.1007/s11633-019-1196-5>.
- [5] Nguyen, T., Leavitt J. ; Jabbari F. ; Bobrow J.E., "Accurate sliding-mode control of pneumatic systems using low-cost solenoid valves", Mechatronics, IEEE/ASME Transactions on, 2007. 12(2): p. 216-219.
- [6] Kunt, C. and Singh, R., "A linear time varying model for on-off valve controlled pneumatic actuators", Journal of dynamic systems, measurement, and control, 1990. 112(4): p. 740-747.
- [7] Šitum, Ž., Novaković, B., and Petrić J., "Pneumatic Servodrives Control Using On/Off Solenoid Valves", 7th Int. Conf. on Prod. Eng. CIM 2001.
- [8] Sorli, M, Figliolini, G., and Almondo A., "A. Mechatronic model and

experimental validation of a pneumatic servo-solenoid valve", *J Dyn Syst Meas Control* 2010; 132(5): 054503.

[9] Shaalan, A., Badr, M., Al-Ameen, E., "Motion control of Electro pneumatic system on Directional Control Solenoid Valve", *International Journal of Mechanical and Production Engineering Research and development (IJMPERD)*, 2019.

[10] Andrighetto, P.L., Valdiero, A., and Bavaresco, D., "Dead-zone compensation in pneumatic servo systems", in *ABCMSymposium Series in Mechatronics*. 2008.

[11] Salim, S., Rahmat, M., Faudzi, A., Ismail, Z., and Sunar, N., "Position Control of Pneumatic Actuator Using Self-Regulation Nonlinear PID", *Mathematical Problems in Engineering*, 2014. 2014.

[12] Kothapalli, G. and Hassan, M.Y., "Design of a neural network based intelligent PI controller for a pneumatic system", *IAENG International Journal of Computer Science*, 2008. 35(2): p. 217-225.

[13] Najjari, B., "Modelling and controller design of electro-pneumatic actuator based on PWM", *IAES International Journal of Robotics and Automation (IJRA)*, 2012. 1(3): p. 125-136.

[14] Bone, G., "Position Control of Pneumatic Actuators Using Three-Mode Discrete-Valued Model Predictive Control", *Actuators* 2019, 8, 56; doi:10.3390/act8030056.

[15] Zhang, X., Lu, Y., Li, Y., Zhang, C., Wang, R., "Numerical calculation and experimental study on response characteristics of pneumatic solenoid valves", *Measurement and Control* 2019, Vol. 52(9-10) 1382–1393

[16] Messina, A., Giannoccaro, N., and Gentile, A., "Experimenting and modelling the dynamics of pneumatic actuators controlled by the pulse width modulation (PWM) technique", *Mechatronics*, 2005. 15(7): p. 859-881.