

## Switching Analysis of Power Distribution Network Including Distributed Generations Using ATP

تحليل عمليات الفصل والتوصيل في شبكات التوزيع الكهربائية المشتملة على مصادر توليد موزع باستخدام برنامج ATP

S.S. Kaddah M.M. El-Saadawi D. M. El-Hassanin  
Skaddah@mans.edu.eg Saadawi1@gmail.com Doaa2543@yahoo.com

Dept. of Electrical Engineering  
Faculty of Engineering  
Mansoura University

### الخلاصة

برزت مصادر التوليد الموزع كخيار مثالي لمواجهة زيادة النمو في الطلب على الكهرباء. وفي وجود هذه الأنظمة الجديدة تتزايد احتمالات حدوث الاضطرابات العابرة في شبكات التوزيع. وهذه الاضطرابات من الممكن ان تحدث نتيجة لعدة اسباب من أهمها حدوث عمليات فصل وتوصيل سواء للأحمال الكبيرة أو لوحدة التوليد. لذلك فان الهدف الأساسي من هذا العمل هو تحديد أفضل مكان لربط مصادر التوليد الموزع، وهل من الأفضل ان تكون في مكان واحد أو ان تكون موزعة في أماكن مختلفة. بالإضافة الي تحديد سعة يمكن ادخالها على شبكة التوزيع دون التأثير على استقرار الجهد أو جودة القدرة، وفي هذا البحث تم الاعتماد على المعايير الأوروبية والمقاييس التقنية لربط مصادر التوليد الموزع مع الشبكات الرئيسية "IEEE 1547". وقد تم تمثيل الظواهر العابرة التي تحدث عند ربط مصادر التوليد الموزع بنسب مشاركة مختلفة وذلك عند ربطها بأماكن مختلفة في شبكة التوزيع لدراسة تأثيرها على استقرار الجهد وجودة القدرة. حيث يكون لهذه المصادر تأثير كبير على أداء الشبكة كونها تعكس اتجاه تدفق القدرة وتؤثر على جودتها. وقد تم استخدام برنامج المحاكاة ATP لتحقيق الأهداف السابقة. كما تم تطبيق الدراسة على نظام قياسي (IEEE 13 node test feeder) ليتمثل نموذج لشبكة التوزيع.

**Abstract** –The distributed generation (DG) emerged as an ideal option deals with the growth in electricity demand. With such a new system there is always a chance of some transient disturbances. A transient can be caused by a number of power system switching events or faults such as lightning strikes, short circuits, or equipment failure. The purpose of this work is to identify the best location of DG connection and if the DG should be concentrated in one location or distributed among different location in distribution network as well as identifying the suitable DG penetration level that can be inserted without affecting the distribution system voltage stability or its power quality based on the European technical standard and the Standard for Interconnecting Distributed Resources with Electric Power Systems "IEEE-1547" standard. To achieve these goals, a transient simulation is developed for DG energization with different penetration levels and different locations on power distribution network to investigate voltage stability and power quality of the distribution system. The DG can greatly affect the voltage profile, reverse power flow, power quality, and so on.

General purpose Alternative Transients Program (ATP) version of Electromagnetic Transient Program (EMTP) is used to accomplish the above goals. IEEE 13 node test feeder distribution system is used in this work.

**Index Term** – Distribution system, Switching analysis, power quality, voltage stability, IEEE 13 node distribution feeder, EMTP/ATP program

## Introduction

Under the current centralized generation paradigm, electricity is mainly produced at large generation facilities, shipped through the transmission and distribution grids to the end consumers.

In a broad definition, the distribution system is that part of the electric utility system between the bulk power source and customer's service switches. This system can be subjected to a sudden change or transient conditions of very short period usually and extremely important for it is at such times that the circuit components are under the greatest stresses from excessive currents or voltages [1]. *Transient Over-Voltage* is defined in the IEEE 1100-1999 as, a sub-cycle disturbance in the AC waveform that is evidenced by a sharp, brief discontinuity of the waveform [2]. Switching operations and faults produce various types of transient over-voltages which can result in voltage stresses with above normal operating values in sections of power distribution system and transformers. Either the switching events is deliberate or intentional, it can cause perturbations in electrical networks.

The resulting transient can propagate through the transmission systems from the points of origin and may eventually reach the transformer terminal.

If the frequency of these external disturbances matches closely with any one of the internal resonance frequencies of the transformer winding, severe internal over voltage may occur due to resonance [3].

Nowadays economical and environmental impacts have alerted the traditional construction of large generation stations to generate and deliver electrical power from alternate energy sources, particularly renewable energy sources. In consequence of this, DG –defined as electrical power generation on relatively small scale, i.e. smaller than 50-100 MW, located in the vicinity of the electrical loads, and mostly connected to distribution networks [4,5]. The DG can support and improve the voltage profiles at load terminals. However the voltage stability is defined as the ability of a power system to maintain the voltages at all nodes within acceptable limits after being subjected to a disturbance [6].

In last decade, many researches were concerning with transient in distribution system interconnected with DG resources. In [7] the authors proved that, the DG affects the voltage profile of the system through the connection point due to its power injection. It can improve and support the voltage profile of the distribution system. The operation power factor of DG has a strong influence on the voltage rise.

In [8] the authors proved that, size and location of the DG are crucial factors in the application of DG for loss minimization. They presented an algorithm to calculate the optimum size of DG at various buses. In [9] the authors investigated a proposed method for placement of DG units in the distribution system in order to enhance the voltage stability and reduce power losses. And in [10] the authors proved that, for the same feeder, distributing an amount of DG power is better than place it at a certain bus. Because the locations of the DG can't be controlled and then this may be in some cases helpful for voltage stability enhancement. And for whole system, distributing the same capacity of DG at all feeders and different locations is better from voltage stability point of view than concentrating the same capacity at one or two feeders only. While in [11], the authors described a few of the issues that must be considered to ensure that DG will not degrade distribution system power quality, safety or reliability.

The objective of this paper is to identify the best DG location and the maximum DG penetration that the distribution system can adopt without degrading the performance based on the standard. Another goal of this paper is to decide if the DG penetration is better to be concentrated at one bus or distributed among two buses.

The elective criteria are chosen to be voltage stability and power quality of the distribution test system.

## **1. DG Representation in Power System**

Gas turbine, diesel engine, fuel cell and wind turbine DGs are four of the several types of new DG technology that have experienced considerable development progress in recent years. The actual generators can be further classified as, synchronous generators, induction generators, and DC to AC converter types of sources. Each of these generators has different characteristics. So it is necessary to know their characteristics before integrating them into the electrical network [12]. In this paper, the synchronous generator is used to represent the DG sources.

### **1.1 Prescribed Rules for the DG Connection.**

The possibility of connecting the DG to the distribution system is judged according to their negative impacts on the distribution system. The European technical standards and the Standard for Interconnecting Distributed Resources with Electric Power Systems "IEEE-1547" bring the requirements for connecting the DG to the distribution network [13, 14].

### 1.2 Penetration Level of the DG

The penetration level can be calculated as a function of the total DG power generation over the total load demand:

$$\text{Penetration level (\%)} = \frac{\sum P_{DG}}{\sum PL} \times 100$$

The maximum level of DG penetration that can be accepted in a specific network is difficult to estimate and subject to research, as the connection of the DG to the grid may influence the stability of the power system such as angle, frequency and voltage stability. It might also have an impact on the protection selectivity, frequency and voltage control of the system [15]. According to different studies made by CIGRE (International council on Large Electric Systems), EPRI (Electrical Power Research Institute), liberalization of power market in Europe, and a similar study by the natural gas foundation, it was believed that the share of the DG in new generation will be 25:30% by the year 2010 [8]. So, the maximum penetration of the DG in this paper is limited to 30%.

## 2. Proposed Procedure

This paper investigates the transient impacts of the DG energization on the distribution network with different penetration level and different location. The transient phenomena follows the switching is analyzed by monitoring the voltage waveform as well as the voltage harmonic content during and after the DG connection.

The proposed procedure is applied using the following steps:

1. Study the voltage profile and harmonic content without the DG connection (base case).
2. Connect the DG units at two different buses, with the load level remains constant as the DG penetration level increases. The following cases are simulated and studied:
  - 10%, 20% and 30% penetration level is integrated as DG1
  - 10%, 20% and 30% penetration level is integrated as DG2
  - Two DGs are integrated at the same time as DG1 and DG2 with 5% penetration level each.
3. Monitor the voltage profile and compute the voltage total harmonic distortion during and after the DG connection.
4. Compare the results with the technical standard to ensure that the working cases are in the permissible limits and reject any other case.
5. Finally, compare the permissible with each other to select the best among them.



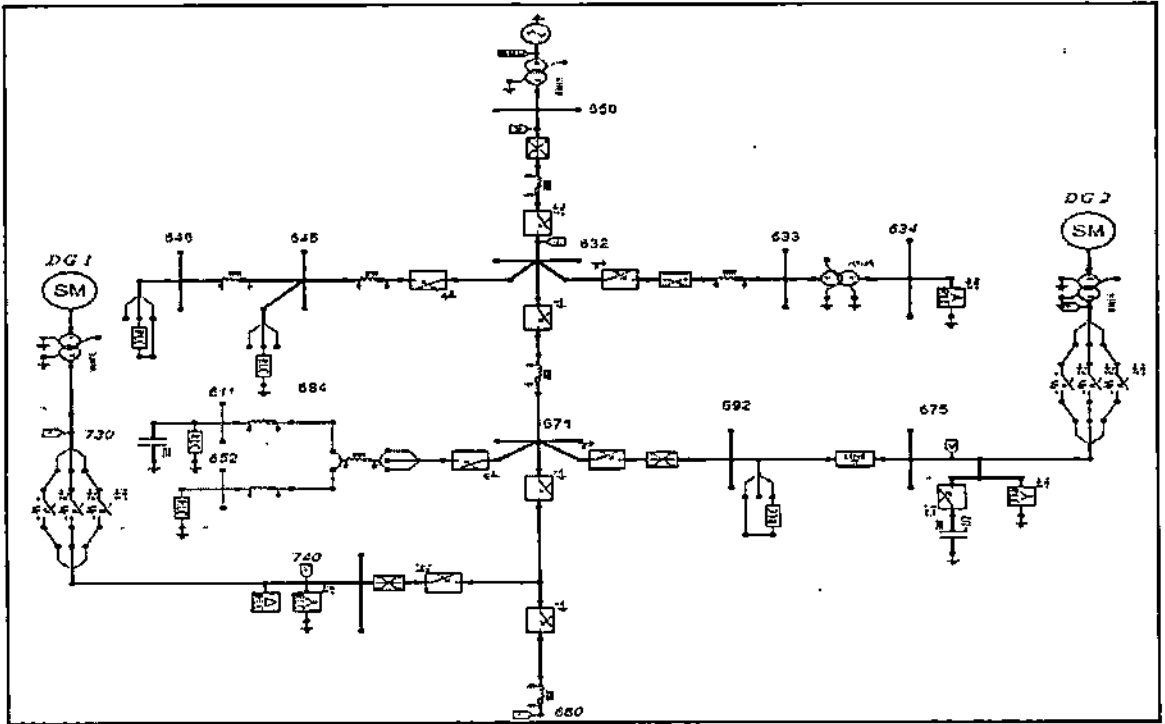

Fig.2. ATP-EMTP model

### 5. Simulation Results

The ATP/EMTP program is implemented to simulate the switching transient of the DG in the following cases:

#### 5.1 Base Case

In this case, the voltage profile of the power system without inclusion of any DG will be studied. This case represents the "normal scenario" or the benchmark for the study. it describe the distribution system with an unbalanced voltage condition. Figure 3 shows the voltages at bus 675 without the DG connection.

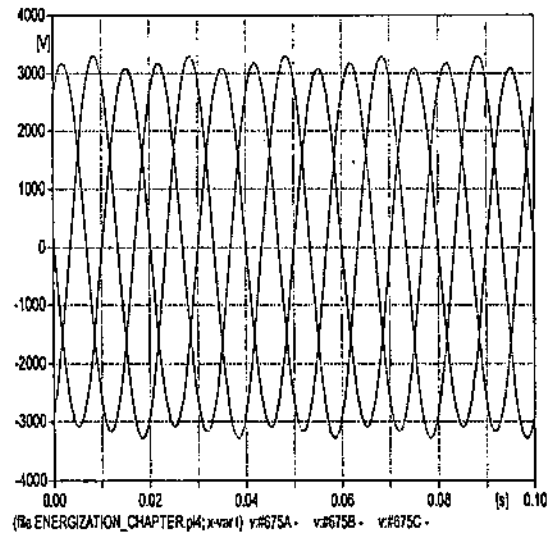

Fig.3. Voltage at bus 675 without the DG connection

Figure 4 shows the histogram of the voltage harmonic content & Table 1 shows the individual harmonic in pu at the bus 675 without the DG connection.

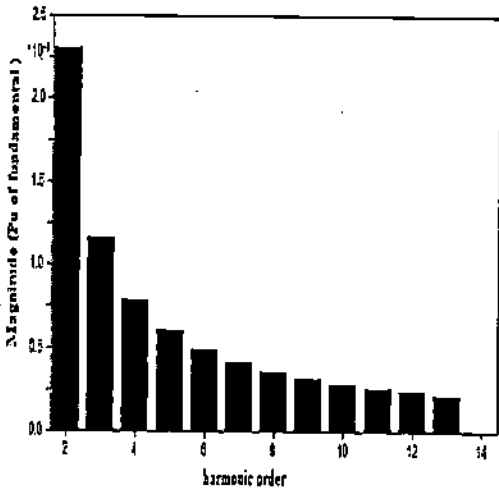

Fig.4. Individual voltage harmonic histogram present in phase A at bus 675.

Table 1: Individual harmonic in phase A at bus 675 (pu)

Harmonic order (n)	pu value for n <sup>th</sup> harmonics
1	1
2	2.2968 e-3
3	1.1549e-3
4	7.8418e-4
5	5.9877e-4
6	4.8641e-4
7	4.1055e-4
8	3.5567e-4
9	3.1402e-4
10	2.8127e-4
11	2.5481e-4
12	2.3289e-4
13	2.1464e-4
<b>THD</b>	<b>0.29081 %</b>

Table 2 shows the voltage total harmonic distortion (THD<sub>V</sub>) summary of the three-phases at all tested buses.

Table 2: THD<sub>V</sub> at the studied buses

Phase / Bus	740	675	634
A	0.295 %	0.296%	0.279%
B	0.275%	0.274%	0.282%
C	0.460%	0.460%	0.460%

Table 1 shows that, THD<sub>V</sub> is 0.29 % in the phase A. Whereas, Table 2 shows the summary of THD<sub>V</sub> in the three-phases at all tested buses. the harmonic content in the voltage is very low and in the acceptable limit. Also, phase C which has lower voltage contains the highest value of THD<sub>V</sub>.

5.2 DG Connected to bus 740

5.2.1 DG penetration level 10%

DG unit is connected to bus 740 (10% penetration level) far away from other source, Figure 5 shows the voltage at bus 740 with the DG connection.

It can be seen from fig.5 below that, during the DG connection (at time ~ 33 ms) there is a small spike appears during the DG connection. The system voltage rises at all phases specially phase C. Fig. 6 shows the difference of the phase voltage during and after the DG connection.

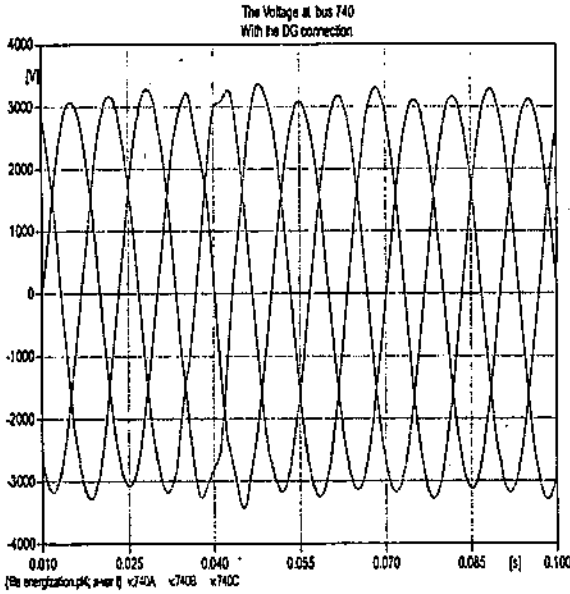
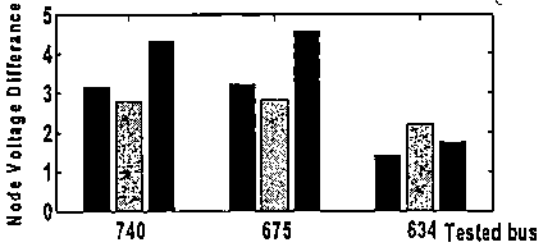

Fig.5. the voltage at bus 740 with the DG connection

Effect of the DG on the node voltage during the DG connection



Effect of the DG on the node voltage after the DG connection

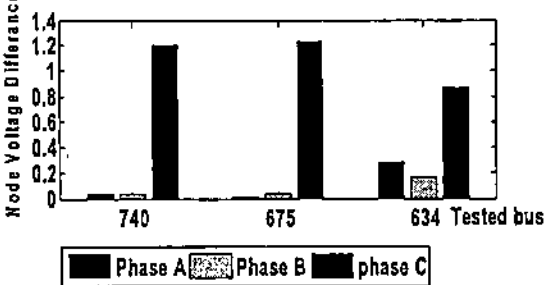

Fig.6. Effect of 10% DG Penetration at Bus 740 on the node voltage

As shown in fig.6, the voltage of phase C that was very low from the beginning captured a very big voltage difference during and after the DG connection resulting in system voltage stabilizing. And the voltage profile at the location that is closer to the placement of the DG is affected more than other location.

Tables 3 and 4 show the THD<sub>v</sub> at the studied buses during and after the DG connection.

Table 3: THD<sub>v</sub> at the studied busses during the DG Connection (10% penetration level)

Phase / Bus	740	675	634
A	4.42%	4.55%	2.41%
B	5 %	5.21%	2.9%
C	4.98%	5.09%	2.623%

As shown in Table 3, the switching of DG effects on the THD<sub>v</sub> at point 675 more than its own position (PCC). But overall, it is considered as an acceptable location as all the values are around 5% (IEEE 1547 standard).

Table 4: THD<sub>v</sub> at the studied busses after the DG Connection (10% penetration level)

Phase / Bus	740	675	634
A	0.2834%	0.284%	0.2668%
B	0.2561%	0.255%	0.2694%
C	0.433%	0.433%	0.4421%



As shown in Table 4 that, apparently the injection of DG power helps to stabilize the voltage because the  $THD_V$  found with the DG connection is less than the corresponding values without the DG connection that were listed in Table 2.

**5.2.2 DG penetration level increased from 10% to 20% and 30%**

In this section, DG units at bus 740 are gradually connected to the system while the production output of the central generator remains the same. The penetration level increases from 10% to 20% and 30%. Figure 7 shows the voltage at the load 740 with the DG penetration level 30 %.

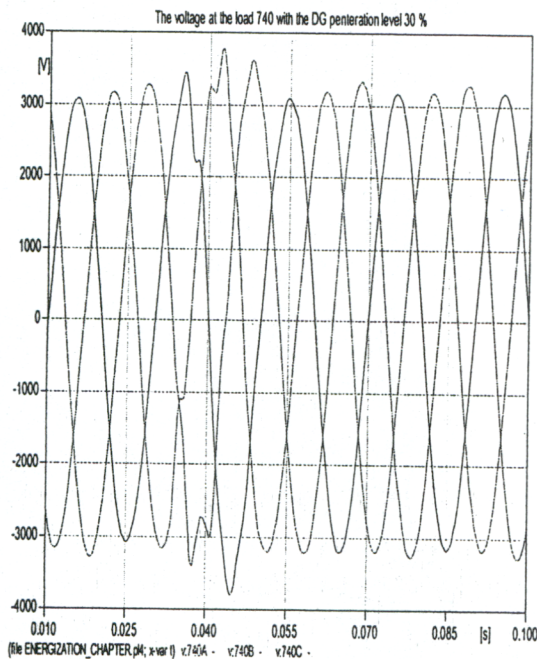

Fig.7. the voltage at load 740 with 30% DG penetration at bus 740

Comparing the voltage profile before and after the DG connection, as illustrated by Fig. 7, shows that increasing the DG penetration level stabilizes the system more and the system phase voltage became almost equal. This could improve the voltage quality of the network system.

Fig.8 Shows the impact of increased the DG penetration level on the PCC voltage (bus 740) during and after the DG connection.

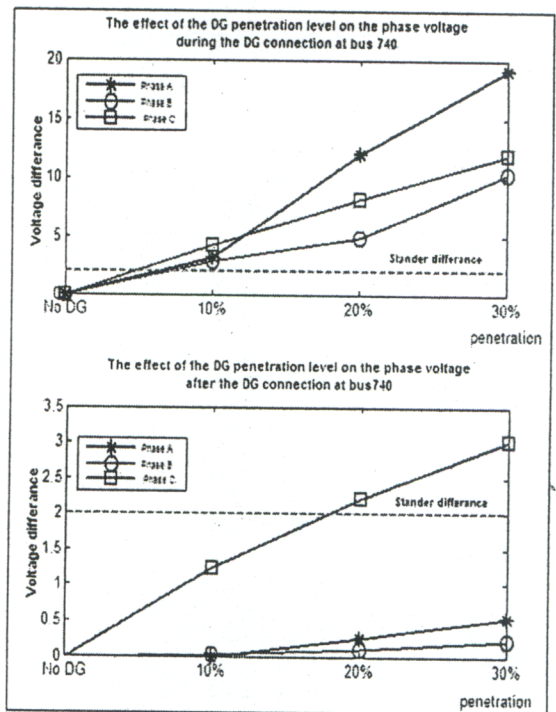

Fig. 8. effect of the DG penetration level on bus 740 phase voltage

As shown in fig.8 that, 10% penetration level is almost acceptable according to the prescribed rules for the DG connection. Wherefore, there are a trade-off between improving the voltage quality of the power system network by increasing the penetration level of the DG, and implementation of the prescribed rules for the DG connection due to, increase the voltage difference above 2% (European technical standards) during and after the DG connection.

Tables 5 & 6 show that, the THD<sub>v</sub> at the PCC during and after the DG connection at different penetration levels.

**Table 5: THD<sub>v</sub> at bus 740 during the DG connection**

Penetration phase	A	B	C
10%	4.42%	5 %	4.98%
20%	7.3 %	8.39 %	7.76%
30%	9.6 %	10.9%	9.45%

**Table 6: THD<sub>v</sub> at bus 740 after the DG connection**

Penetration phase	A	B	C
10%	0.28%	0.26%	0.43%
20%	0.3 %	0.26%	0.44 %
30%	0.33%	0.29 %	0.43%

It is shown in Table 5 that, THD<sub>v</sub> during the DG connection with more than 10% exceeds 5% but the transient vanished in about half cycle (as previously shown by Fig.7).

However, the THDV is reduced to an acceptable limit after the DG connection as shown in Table 6. And almost equals to the corresponding values without the DG connection. So, in this location a 10% penetration level is a very desirable option that helps in reducing the voltage harmonic and stabilizing the voltage profile.

**5.3 DG connected to bus 675**

**5.3.1 DG Penetration Level 10%**

In order to compare the effect of the DG location, the same procedure is repeated using DG with a penetration level of 10 % connected at bus 675. Fig. 9 shows the voltage at bus 675 with the DG connection.

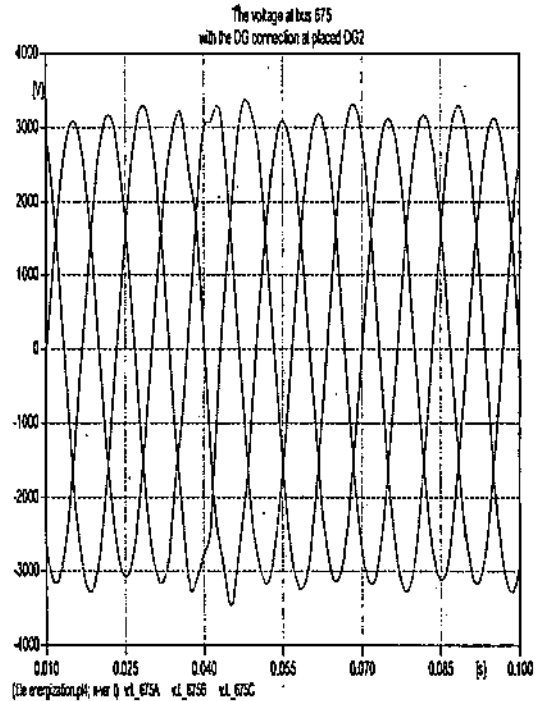

**Fig.9. Voltage at bus 675 with the DG connection**

It is shown in fig.9 that, the voltage during the DG connection has a small spike, and after the DG connection the voltage raises at all phases. Figure 10 shows the voltage difference at all phases due to 10 % DG penetration level at bus 675.

Table 7 & Table 8 show the THD<sub>v</sub> at studied busses for the three phases during and after 10% DG penetration connection at bus 675.

**Table 7: THD<sub>v</sub> at the studied busses during the DG Connection (10% penetration level)**

	740	675	634
A	4.55%	4.74%	2.48%
B	5.211 %	5.41%	2.95%
C	5.06%	5.285%	2.66%

As shown from Table 7, the THD<sub>v</sub> during the DG connection at bus 675 exceeds the prescribed limit. However, it is in the acceptable limit after connection as shown in Table 8. So, if there is a way to reduce the THD<sub>v</sub> during connection, this place could be acceptable. Otherwise, the connection at bus 740 is preferable.

**Table 8: THD<sub>v</sub> at the studied busses after the DG Connection (10% penetration level)**

	740	675	634
A	0.285%	0.286%	0.267%
B	0.256%	0.255%	0.269%
C	0.43%	0.43%	0.44%

**5.3.2 DG penetration level increased from 10% to 20% and 30% at Bus 675**

DG units at bus 675 are gradually increased from 10% penetration to 20% and then to 30%. Fig.11 shows the impact of increasing the DG penetration level on the PCC voltage (bus 675) during and after the DG connection.

Effect of the DG on the node voltage during the DG connection

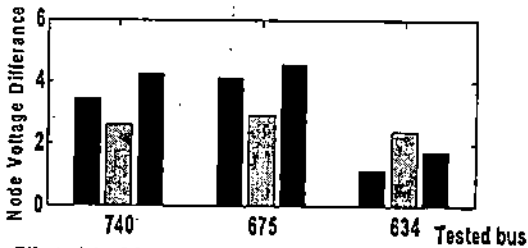

Effect of the DG on the node voltage after the DG connection

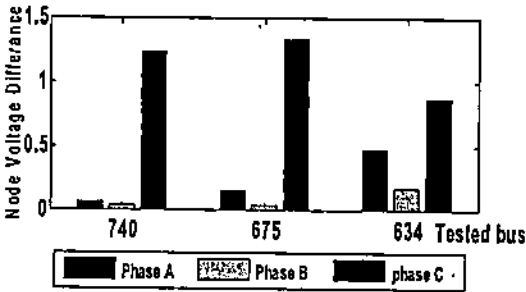

**Fig.10. effect of 10% DG penetration at bus 675 on the node voltage**

It is shown in fig.10 that, the voltage difference at load 675 is more affected than other location unlike when the DG connected to bus 740. Also the voltage difference increases during and after the DG connection than the corresponding values when the DG connected to bus 740, which reaches 4.54% in phase C at bus 675 comparing with corresponding value 4.15% during the DG connection and 1.33% comparing with a corresponding value of 1.26% after the DG connection.

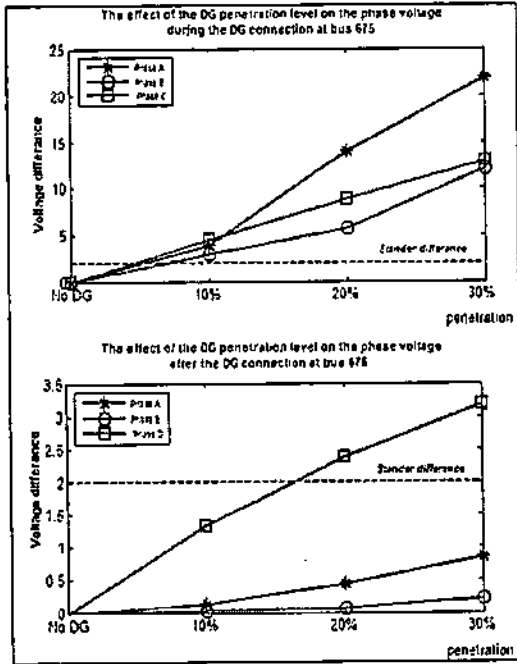

Fig.11. the effect of the DG penetration level on bus 675(PCC) phase voltage

As shown in fig.11 that, the voltage difference with the DG connected to bus 675 is greater than the corresponding values when the DG connected to bus 740 during and after the DG connection.

Table 9 and table 10 show the THD<sub>v</sub> at the PCC during and after the DG connection.

Table.9: THD<sub>v</sub> at bus 675 during the DG connection

Penetration phase	A	B	C
10%	4.74%	5.41%	5.29%
20%	7.84 %	8.9 %	8.7 %
30%	10.5 %	11.6%	9.8 %

Table 10: THD<sub>v</sub> at bus 675 after the DG connection

Penetration phase	A	B	C
10%	0.29%	0.26%	0.43%
20%	0.3 %	0.26 %	0.43 %
30%	0.34%	0.29	0.43%

As shown in Table 9 that, during the DG connection, THD<sub>v</sub> exceeds 5% which is higher than the corresponding values when the DG is connected to bus 740 at the same penetration level. However, it is in the acceptable limit for all the studied penetration levels after the DG connection as shown in Table 10.

### 5.4 DG Connected to bus 740 and 675

To analyze the effect of either distributing the DG value on two sites or collecting on one site, a comparison is held among using 10% DG penetration level allocated at bus 740 or bus 675, with (5 % penetration allocated at bus 740 + 5 % penetration level at bus 675).

Figure 12 shows the voltage at bus 740 with the DG connected as (5 % penetration allocated at bus 740 + 5 % penetration level at bus 675).

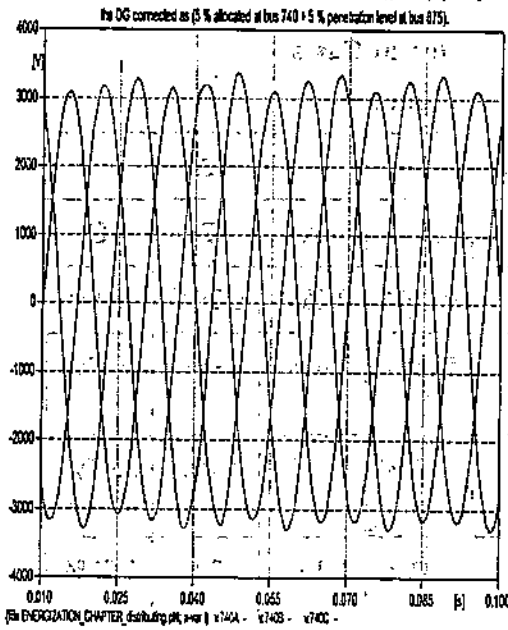
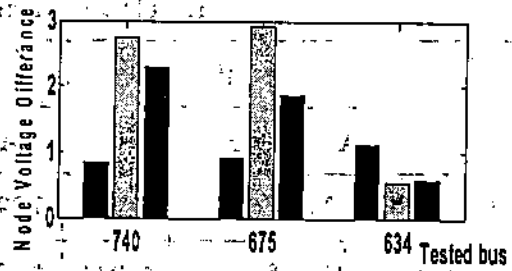

Fig.12. effect of 10% DG Penetration connected as a distributed among bus 740 and bus 675

As shown in fig.12 that, during the DG connection (at time ~33- ms) there is a very small variation appears on voltage profiles. The same result found in the studied buses. Figure. 13 shows the difference of the phase voltage during and after the DG connection.

Effect of the DG on the node voltage during the DG connection



Effect of the DG on the node voltage after the DG connection

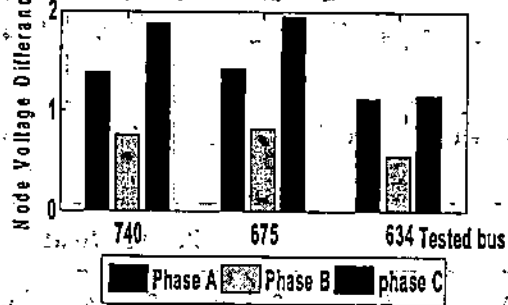

Fig.13. effect of DG as a distributing power on the studied buses node voltage

As shown in Fig. 13, the voltage rises at all phases and, at all studied buses with a range 0.55% - 1.94% after the DG connection and 0.55% -2.92% during the DG connection, which has a lower value than the DG penetration level 10%, allocated at bus 740 or bus 675.

Table 11 shows a comparison, among using 10% DG penetration level allocated at bus 740 or bus 675, and as (5% allocated at bus 740, + 5% allocated at bus 675) from the voltage harmonic content point of view.

Table. 11: Comparison of THD<sub>v</sub> at Different Cases

1. THD<sub>v</sub> during the DG connection

Location phase	740			675			634		
	A	B	C	A	B	C	A	B	C
No DG	0.29%	0.27%	0.46%	0.29%	0.27%	0.46%	0.28%	0.29%	0.49%
10% at bus 740	4.42%	5 %	4.98%	4.55%	5.21%	5.09%	2.41%	2.9%	2.62%
10% at bus 675	4.55%	5.21	5.06%	4.74%	5.41%	5.29%	2.48%	2.95%	2.66%
5% at each bus	2.36%	2.07%	2.24%	2.44%	2.13%	2.31%	1.3%	1.24%	1.23%

2. THD<sub>v</sub> after the DG connection

No DG	0.29%	0.27%	0.46%	0.29%	0.27%	0.46%	0.28%	0.29%	0.468 %
10% at bus 740	0.28%	0.26%	0.43%	0.28%	0.25%	0.43%	0.27%	0.27%	0.44%
10% at bus 675	0.29%	0.26%	0.43%	0.29%	0.26%	0.43%	0.27%	0.27%	0.44%
5% at each bus	0.28%	0.26%	0.44%	0.28%	0.26%	0.44%	0.27%	0.28%	0.45%

As shown in Table 11 during the DG connection that, distributing the same capacity of DG at two buses is better than concentrating the same capacity at one bus only. Also, it shows that the THD<sub>v</sub> of the load 634 that is far from the placement of the DG is less affected than other location.

Also, it shows that 10% penetration level concentrated at bus 740 produces less THD<sub>v</sub> than inserting the same amount at bus 675.

6. Conclusions

In this paper, the impact of the DG energization on distribution system is being studied. Based on the obtained results it can be concluded that, ATP is a suitable tool to study the integration of distributed energy resource into power systems.

From the simulations we can make these conclusions:

- The addition of the DG in the power distribution network improves the voltage profile of the system and help to stabilize the unbalanced voltage. That could improve the voltage quality.
- Based on the location that DG is placed, it could be seen that the voltage profile of the location that is nearer to the placement of the DG is affected more than other locations.
- There is a trade-off between improving the voltage quality of the power system network by increasing the penetration level of the DG, and implementation of the prescribed rules for the DG connection, due to increase the voltage difference during and after the DG connection.
- Based on the nature of the system, there is always a location which is the best place for the DG to be interconnected based on voltage harmonic content value.
- Distributing the same capacity of DG at two buses and different locations is better from voltage stability point of view than concentrating the same capacity at one bus only.

Appendix

Table A1. 410 KVA Synchronous Generator Parameters

$V_{Rated}$ (V)	480	$X_d'$ (pu)	0.21
$KVA_{Rated}$	410	$X_q'$ (pu)	0.18
$P_{Rated}$ (KW)	350	$X_d''$ (pu)	0.13
$V_{Scheduled}$ (pu)	1	$X_q''$ (pu)	0.11
$Q_{max}$ (pu)	0.5	$r_a$ (pu)	0
$Q_{min}$ (pu)	-0.25	$r_s$ (pu)	0
pf	0.85365	$r_H$ (pu)	0
$X_d$ (pu)	1.76	$X_{lr}$ (pu)	0
$X_q$ (pu)	1.66	$X_0$ (pu)	0.065

Table A 2. 200 KVA Synchronous Generator Parameters

$V_{Rated}$ (V)	480	$X_d'$ (pu)	0.353
$KVA_{Rated}$	200	$X_q'$ (pu)	0
$P_{Rated}$ (KW)	160	$X_d''$ (pu)	0.214
$V_{Scheduled}$ (pu)	1	$X_q''$ (pu)	0.232
$Q_{max}$ (pu)	0.5	$r_a$ (pu)	0
$Q_{min}$ (pu)	-0.25	$r_s$ (pu)	0
pf	0.8	$r_H$ (pu)	0
$X_d$ (pu)	3.74	$X_{lr}$ (pu)	0
$X_q$ (pu)	2.066	$X_0$ (pu)	0.0099

REFERENCES

[1] S. Boutora, H. Bentarzi and A. Ouadi, "Analysis of the Disturbances in Distribution Networks using Matlab and ATP", International Journal of Energy, issue 1, Vol. 5, 2011.

[2] D.B. Mupparty, "Capacitor Switching Transient Modeling and Analysis on an Electrical Utility Distribution System using Simulink Software" (2011), Master's Thesis, University of Kentucky  
[http://uknowledge.uky.edu/gradschool\\_theses/82](http://uknowledge.uky.edu/gradschool_theses/82)

- [3] P. Mitra, A. De, and A. Chakrabarti, "Study of the Transient Overvoltage Profiles in the Power Distribution Network of Durgapur Steel Plant (DSP)", 16th National Power Systems Conference, Osmania University, Hyderabad, India 15-17 December, 2010.
- [4] A. S. El Safty, B. M. Abd El Geliel, and C. M. Ammar, "Distributed Generation Stability during Fault Conditions", International Conference on Renewable Energies and Power Quality (ICREPQ'10) Granada (Spain), 23-25 March, 2010.
- [5] M. Reza, D. Hamdani, "Distributed Generation Potential in Indonesia", International Conference on Electrical Engineering and Informatics, Institute Technology Bandung, Indonesia June 17-19, 2007.
- [6] IEEE/CIGRE joint task force on stability terms and definitions, "Definition and Classification of Power System Stability", IEEE Transactions on Power Systems, Vol. 19, No. 3, 2004, pp. 1387-1401.
- [7] T. Vuvan, A. Woyte, "Impacts of Distributed Generation on Distribution System Power Quality", the International Conference of Electrical Power Quality and Utilization September 17-19, 2003, Cracow, Poland.
- [8] N. Acharya, P. Mahat and N. Mithulananthan, "An Analytical Approach for DG Allocation in Primary Distribution Network", Electrical Power and Energy Systems 28 (2006) 669-678.
- [9] K.V. Kumar, B. S. Kumar, and M. P. Selvan, "Voltage Stability Enhancement of Radial Distribution System Using Distributed Generators", 16th National Power Systems Conference, Osmania University, Hyderabad, India 15-17 December, 2010.
- [10] N. Hemdan, M. Kurrat, "Distributed Generation Location and Capacity Effect on Voltage Stability of Distribution Networks", Annual IEEE Conference, 15-26 Feb. 2008.
- [11] S. Shrivastava, S. Jain and R.K. Nema, "Distributed Generation: Technical Aspects of Interconnection", International Journal on Emerging Technologies 1(1): 37-40(2010).
- [12] V. R. Kanduri "Distributed Generation Impact on Fault Response of A Distribution Network", master's Thesis, Mississippi State University, Dec. 2004.
- [13] E.V. Mgaya, and Z. Müller, "The Impact of Connecting Distributed Generation to the Distribution System", ACTA Polytechnica Vol. 47 No. 4-5/2007.



- [14] IEEE Std. 1547-2003 "Interconnecting Distributed Resources with Electric Power System", Standards Coordinating Committee 21, June 2003.
- [15] V. Van Thong, D. Van Dommelen, Johan Driesen, Ronnie Belmans, "Impact of Large Scale Distributed and Unpredictable Generation on Voltage Angle Stability of Transmission System", 21, rue d'Artois, F-75008 Paris, Session 2004.  
<http://www.cigre.org>
- [16] W. H. Kersting, "Radial Distribution Test Feeders", IEEE Power Engineering Society Winter Meeting, 2001. Volume: 2, 28 Jan.-1 Feb. 2001 pp. 908-912 vol.2.
- [17] F. Jurado, N. Acero, J. Carpio and M. Castro, "Using Various Computer Tools in Electrical Transients Studies", 30th ASEE/IEEE Frontiers in Education Conference, October 18 - 21, 2000 Kansas City.
- [18] Z. Miao, I. Christie and A. Feliachi "Modeling and Dynamic Stability of Distributed Generations", PhD Thesis, Lane Department of Computer Science and Electrical Engineering of Morgantown West Virginia University, 2002.
- [19] M. Danyek, P. Handl and D. Raisz, "Comparison of Simulation Tools ATP-EMTP and MATLAB-Simulink for Time Domain Power System Transient Studies".  
[www.ipst.org/techpapers/IPST99 Paper 013](http://www.ipst.org/techpapers/IPST99_Paper_013)
- [20] T. Degner, A. Engler and O. Osika, "Modeling of Distributed Energy Resources with ATP-EMTP", European ATP-EMTP Users Group Meeting and Conference, 12.-14. September 2005, Warsaw, Poland.
- [21] Alternative Transients Program (ATP) Rule Book, Canadian/American EMTP User Group, 30 October 2010
- [22] Electro-Magnetic Transients Program (EMTP) Theory Book, Bonneville Power Administration, USA, September 29, 2008.