

Performance of Low Voltage Ride-Through Protection Techniques for DFIG Wind Generator

مقارنة بين نظم الحماية لمولد رياح حتى ثنائي التغذية

M. M. Kabsha Nagy Y. Abed Gabr Abdlsalam

Dept. of Electrical Engineering, Faculty of Engineering, Mansoura University

ملخص البحث:

في الآونة الأخيرة تزايد استخدام طاقة الرياح بشكل كبير في توليد الطاقة الكهربائية حتى أصبحت تشكل نسبة ملموسة من القدرة المولدة داخل الشبكات الكهربائية وأجبرت هذه الزيادة مشغلي الشبكة على وضع مواصفات قياسية لتوصيل مولدات طاقة الرياح بالشبكة. ومن هذه المواصفات ضرورة بقاء مولدات طاقة الرياح في الخدمة عند حدوث خطأ في الشبكة المتصلة بدلا من فصلها مباشرة وبالتالي لا تفقد الشبكة جزء من القدرة المولدة مما يزيد استقرارها بدون فصل احمال وتعود الى طبيعتها بعد ازالة الخطأ. وقد قامت كل شبكة كهربية بوضع شروط للفصل تتضمن قيم ومخططات لجهد الشبكة مع الزمن يجب ان تتبعه وحدة التوليد بحيث عندما يكون الجهد خارج القيم المسموح بها لمدته زمنية معينة يتم فصل المولد اما لو كان قيمة الجهد داخل الحيز المسموح به لا يتم فصل الوحدة مباشرة بل يتم عمل حماية لها اثناء الخطأ لآحماد التيارات والجهود العالية دون فصل المولد عن الشبكة. ويوجد انواع كثيرة من مولدات الرياح والنوع المستخدم بكثرة حاليا هو المولد الحثي الثنائي التغذية وذلك لمميزات العديدة ومنها ان المولد يعمل عند اقصى قدرة عند سرعات مختلفة للرياح وقدرة على توليد قدرة غير فعالة. وفي هذا البحث تم دراسة استخدام خمسة طرق مختلفة لمساعدة المولد الحثي الثنائي التغذية للبقاء في الخدمة اثناء حدوث اخطاء مختلفة داخل الشبكة وتقليل تاثير الخطأ على أجزاء المولد الاكترونية. والطرق هي كالتالي اولا حماية باستخدام العزل الاكتروني لعزل الجزء الاكتروني من العضو الدوار عن الشبكة ثانياً مقطع التيار المستمر ثالثاً مقاومات التوالي الديناميكية و طريقتين مركبتين باستخدام مقطع التيار المستمر مع العزل الاكتروني و مقاومات التوالي الديناميكية مع مقطع التيار المستمر وقد تم عمل مقارنة بين اداء نظم الحماية المختلفة عند انواع مختلفة من الاخطاء المتماثلة وغير المتماثلة لمعرفة مدى قدرة كل طريقة على الحماية.

Abstract:

Due to the increase of the number of wind turbines connected directly to the electric utility grid, new regulator codes have been issued that require Low-Voltage Ride-Through capability (LVRT) for wind turbines so that they can remain online and support the electric grid during low voltage fault events instead of direct tripping of the wind turbines. This LVRT capability will increase the stability of the network and reduce the need for load shedding after the fault clearance. Each utility has its own grid codes for this LVRT. There are many types of wind generators, and currently the Doubly Fed Induction Generator (DFIG) is the most popular type among the leading wind turbine (WT) manufacturers. In this paper five LVRT methods for protection of DFIG during LV events are implemented and compared. The five methods are Crowbar, DC Chopper, series dynamic resistances, and two hybrid methods that combine DC chopper with Crowbar and DC chopper with series dynamic resistances respectively. These methods were tested under different types of fault including symmetrical and unsymmetrical faults and their performances were compared.

Keywords: DFIG, LVRT, Crowbar, DC Chopper, SDR.

by the bi-directional transfer of slip power via the frequency converter. Also the cost reduction compared to the Full Converter Wind generation (Type 4) as the rating of the rotor converter unit is about 25%-30% of the total power rating of the generator,

I. Introduction

In the last 15 years, the use of doubly-fed induction generator (DFIG) in modern variable-speed wind turbines has increased rapidly [1]. The speed variability is ensured

and the penetration of this wind energy into the power system has resulted in the power system operators revising the grid codes.

A special focus in these requirements is drawn to the wind turbine fault ride-through capability (LVRT). The Fault ride-through capability addresses primarily the design of the wind turbine controller in such a way that the wind turbine is able to remain connected to the network during grid faults also, they can contribute to voltage support during and after the fault. The Crowbar system is essential to avoid the disconnection of the doubly fed induction wind generators from the network during faults through the disconnection of the machine side converter. The SDR and DC chopper protect DFIG and converter unit without the disconnection of the machine side converter (RSC).

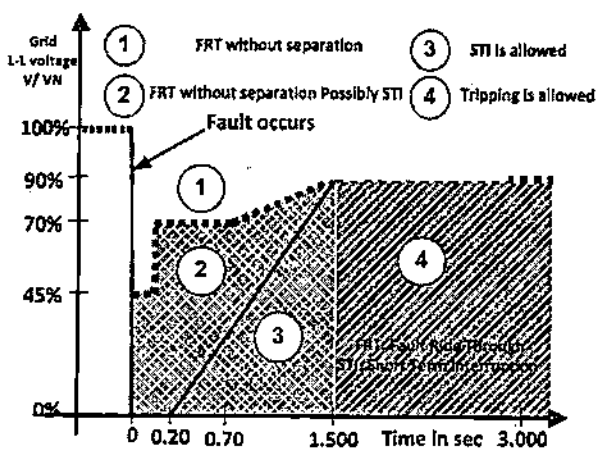

Fig.1 Fault Ride Through-short Time Interruption Behavior

In the past wind turbines were separated from the grid following grid faults which

lead to the loss of a portion of the grid power generation. Existing grid codes tackle this problem by imposing conditions for connecting wind farms in terms of voltage dip behavior. An example of such LVRT requirement by German system operator E.ON Netz is shown in Figure 1 [2]. These requirements are intended to ensure that the wind generators will remain connected during a fault in the grid outside the protection range of the generating unit (with the voltage-time profile falls within the shaded area). Grid code for high and extra high voltage in area 2 the interruption time allowed is around few hundred milliseconds. Short term interruption (STI) is allowed under specific circumstances. The STI in area 3 requires resynchronization within 2 s with a power increase rate of at least 10% of the nominal power per second.

In addition, wind farms are required to contribute to the voltage restoration of the power system by injecting additional reactive power during a voltage dip. To do this, the voltage control must be activated in the event of a voltage dip of more than 10 % of the effective value of the generator voltage. The voltage control must take place within 20 ms after fault recognition by providing a reactive current on the low voltage side of the generator transformer amounting to at least 2 % of the rated current for each percent of the voltage dip.

A reactive power output of at least 100 % of the rated current must be possible if necessary [2]

This paper is organized as follows: In section II the modeling details of DFIG with three different LVRT schemes and two hybrid schemes are outlined and their switching strategy is explained, in section III the behavior of the DFIG under various grid faults with and without the different LVRT protection techniques is evaluated using PSCAD/EMTDC simulations, and in section V a comparison between the different proposed LVRT protection schemes performance is outlined and discussed.

II. Description of DFIG

Figure 2 shows the overall DFIG wind generation system. In DFIG turbines, the induction generator is a wound-rotor induction machine. The stator is directly connected to the grid while the rotor is connected through a back-to-back power converter. Because only part of the real power output flows through the rotor circuit, the power rating of the converter need only be about 25% - 30 % of the rated turbine output [1]. The grid side converter is connected to the grid via three chokes to filter the current harmonics. A control system is employed to regulate the rotor frequency (and thus the voltages and

currents in the rotor) to extract the maximum possible power from the wind.

Modeling of the DFIG consists of modeling of the Machine, the rotor-side converter (RSC), the grid-side converter (GSC) schemes, the control system and the protection system.

A. DFIG modeling

In order to represent a more detailed dynamic behavior of the generator under fault conditions, a fifth-order dynamic model of the DFIG is adopted in this study. From the per-phase equivalent circuit of the DFIG in an arbitrary reference frame rotating at synchronous angular speed ω_s , the following stator and rotor voltage and flux equations can be derived:

$$v_{ds} = -R_s i_{ds} - \omega_s \psi_{qs} + \frac{d\psi_{ds}}{dt} \quad (1)$$

$$v_{qs} = -R_s i_{qs} + \omega_s \psi_{ds} + \frac{d\psi_{qs}}{dt} \quad (2)$$

$$v_{dr} = -R_r i_{dr} - \omega_r \psi_{qr} + \frac{d\psi_{dr}}{dt} \quad (3)$$

$$v_{qr} = -R_r i_{qr} - \omega_r \psi_{dr} + \frac{d\psi_{qr}}{dt} \quad (4)$$

$$\begin{bmatrix} \psi_{ds} \\ \psi_{dr} \end{bmatrix} = \begin{bmatrix} L_{ss} & L_M \\ L_M & L_{rr} \end{bmatrix} \begin{bmatrix} i_{ds} \\ i_{dr} \end{bmatrix} \quad (5)$$

$$\begin{bmatrix} \psi_{qs} \\ \psi_{qr} \end{bmatrix} = \begin{bmatrix} L_{ss} & L_M \\ L_M & L_{rr} \end{bmatrix} \begin{bmatrix} i_{qs} \\ i_{qr} \end{bmatrix} \quad (6)$$

$$\text{Where: } \begin{aligned} L_{ss} &= L_s + L_M \\ L_{rr} &= L_r + L_M \end{aligned} \quad (7)$$

Where v are voltages in Volt (V), i are currents in Ampere (A), R_s, R_r, L_s, L_r are resistances and inductances of the stator and rotor windings, L_M is the main inductance, $V_{ds}, V_{qs}, V_{dr}, V_{qr}, i_{ds}, i_{qs}, i_{dr}, i_{qr}, \psi_{ds}, \psi_{qs}, \psi_{dr}$ and ψ_{qr} are the d and q components of the space vectors of the stator and rotor voltages, currents and flux linkage, ω_r is the rotor speed and ω_s is the synchronous speed. All quantities are referred to the stator. The rotor currents are controlled by the rotor side voltage source converter.

The electromagnetic torque is given by:

$$T_{em} = p(\psi_{ds}i_{qs} - \psi_{qs}i_{ds}) \quad (8)$$

Where: p is the number of pole-pairs.

B. Control of back-to-back converters

The back-to-back converter consists of a rotor side converter (RSC) and a grid side

converter (GSC) connected to the grid by a line filter to reduce the harmonics caused by the converter. The control of the rotor-side converter (RSC) and the grid-side converter (GSC) is shown in Fig. 2. The RSC is used to control the wind turbine output power and the reactive power (or voltage) measured at the grid terminal. The power is controlled in order to follow maximum power tracking. The GSC is used to regulate the voltage of the DC bus capacitor. The objective is to provide constant voltage to the rotor-side converter by keeping the DC voltage at the DC link between RSC and GSC constant. In addition, this converter can also generate or absorb reactive power.

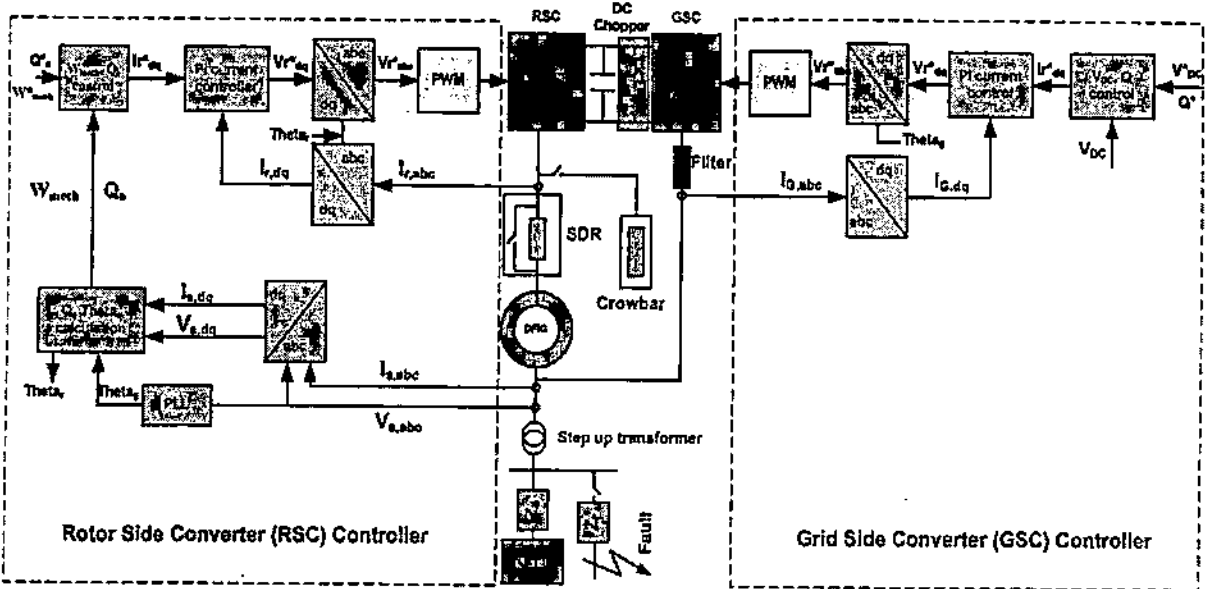

Fig 2 Schematic diagram of DFIG WTGs Control structure

III. LVRT protection schemes

A. Crowbar protection circuit

The considered crowbar protection circuit is composed of three phase diodes bridge and bypass resistors [3-5]. The Passive crowbar control connects the crowbar resistance bypassing the RSC until the interruption of DFIG. The active crowbar control scheme connects the crowbar resistance when necessary and disables it to resume DFIG control without interruption of DFIG. The crowbar circuit used in this paper consists of three-phase rectifier, power resistor and a series IGBT switch and the turn off ability of the IGBT is necessary for Active crowbar as shown in Fig. 3.

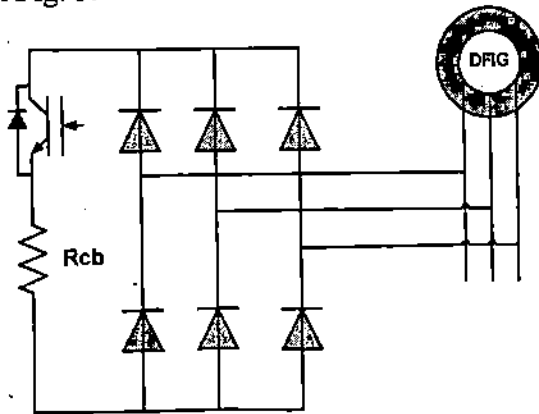

Fig .3 Crowbar Protection circuit

The control strategy of the Crowbar switching is shown in Fig. 4. When the value of the terminal voltage decrease below the threshold value of comparator the Crowbar will be switched on and the RSC will be switched off by stopping its IGBTs operation. When the terminal voltage exceed the threshold value the Crowbar will be switched off, and the RSC will be switched on.

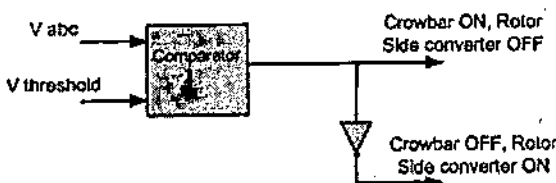

Fig .4 switching strategy of Crowbar

B. DC Chopper Protection circuit

The DC chopper consists of power resistor which is connected in parallel with the DC

capacitor through IGBT power switch in order to have the ability to turn off the DC chopper when the DC voltage is within the range. It's connected in parallel with the dc-link capacitor to protect it from the overvoltage during low grid voltage [6]. This protects the DC link capacitor and IGBTs from overvoltages resulted from various grid faults [7]. The DC chopper circuit is shown in Fig. 5.

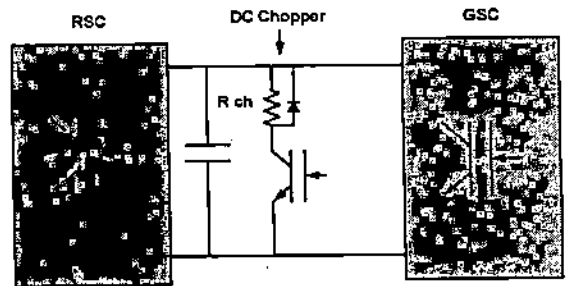

Fig .5 DC Chopper circuit

The control strategy of the DC Chopper switching is shown in Figure 6. When the value of the DC-link voltage exceed the threshold value of the comparator the Chopper will be switched on but the RSC still connected to the rotor of the DFIG, and when the DC voltage decrease under threshold value the DC Chopper will turn off.

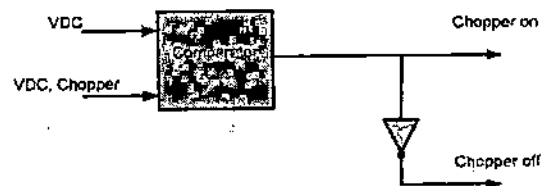

Fig .6 switching strategy of DC chopper.

C. SDR Protection circuit

In this technique, the series dynamic resistor is connected in series with the rotor, and this connection can limit the overcurrents during the fault events. The layout of the SDR Protection circuit is shown in Figure 7. SDR is controlled by a power-electronic switch, in normal operation, the switch is on and the resistor is bypassed; during fault conditions, the switch is OFF and the resistor is connected in series with the rotor windings. The main differences among the SDR, the crowbar

and the dc-link Chopper is its connection topology. The crowbar and the DC Chopper are both shunt-connected devices and control the voltage while the SDR has the distinct advantage of controlling the current magnitude directly. Moreover, with the SDR, the high voltage will be shared by the series resistance; therefore, the induced overvoltage may not lead to the loss of converter control. SDR can limit the rotor overvoltage as well as limit the high rotor current during the faults. The rotor current limiting can reduce the charging current to the dc-link capacitor, and hence avoid dc-link overvoltage.

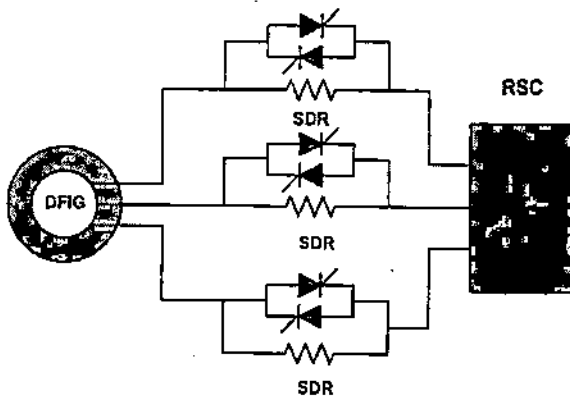

Fig. 7 SDR Protection circuit

The control strategy of the SDR switching is shown in Fig. 8. When the value of the generator terminal voltage decrease under the threshold value of comparator the SDR will be switched on, but the RSC still connected to the rotor of the DFIG and when the terminal voltage exceed the threshold value the SDR will be switched off.

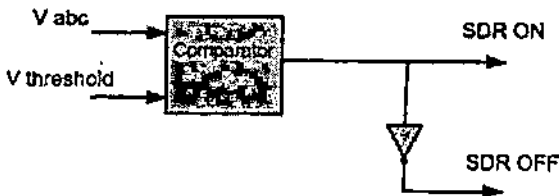

Fig. 8 switching strategy of SDR

IV. Simulation Results

To evaluate the effectiveness of the different LVRT protection techniques simulations have been performed using PSCAD/EMTDC for a 2 MW DFIG wind

turbine system as shown in Fig. 2. The generator parameters are given in the appendix. The control structure as shown in Fig. 2 is implemented. The different LVRT protection techniques described were implemented using PSCAD.

A series of test cases were conducted on a test system in which the DFIG is connected through step up transformer to the grid. The fault was created on the grid side of the step-up transformer using a controlled switch.

A. Performance without any LVRT protection

The objective of this section is to show the effects of a short circuit fault without any LVRT counter protection on the DFIG wind generator. These low voltage grid faults will lead to overcurrents and overvoltages that stress the DFIG and its converters.

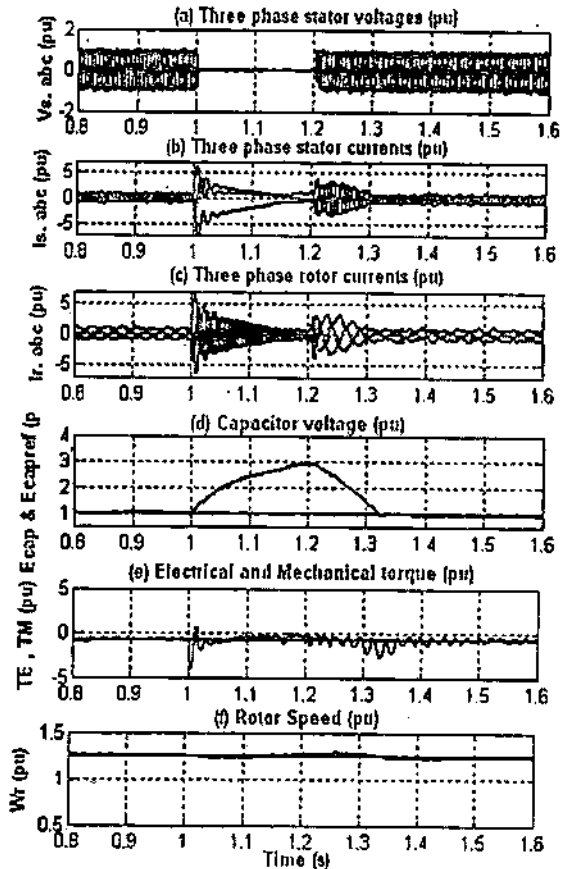

Fig. 9 Three phase fault with 0.95 p.u. voltage dip for 0.2 sec without any LVRT protection system

Figures 9, 10 and 11 show the simulation results for a three phase to ground fault

with 0.95 p.u. voltage dip on the DFIG terminal, phase to phase fault, and single phase to ground fault with 0.95 p.u. voltage dip respectively.

For symmetrical faults as shown in Figure 9, the rotor currents increase abruptly both at the beginning and at the end of the fault, but decreased slowly during the fault. On the other hand the unsymmetrical faults as shown in Figure 10 and in Figure 11 are more stressful on the DFIG than symmetrical faults.

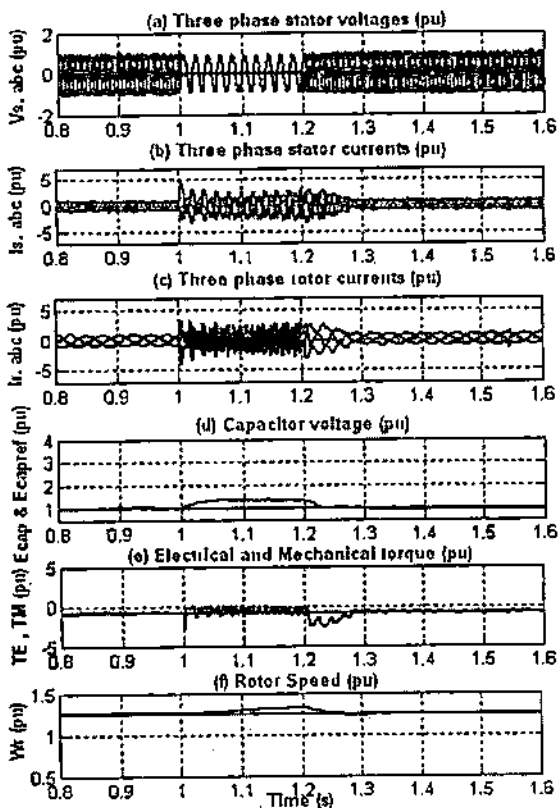

Fig .10 phase to phase fault, voltage dip with 0.2 s without protection

The overcurrents of the unsymmetrical faults increase at the beginning of the faults and remain constant at this value during the fault. So the thermal stress on the DFIG windings and power electronics devices is high during unsymmetrical faults than symmetrical faults.

From the simulation of a symmetrical fault it was found also that the DC link voltage increased rapidly to a high value 3 p.u. which is higher than the DC link rating and may damage the DC capacitor and the IGBTs of RSC and GSC, but with

unsymmetrical faults the DC link voltage increase by small value, and the DC capacitor and IGBTs may withstand this voltage without damage.

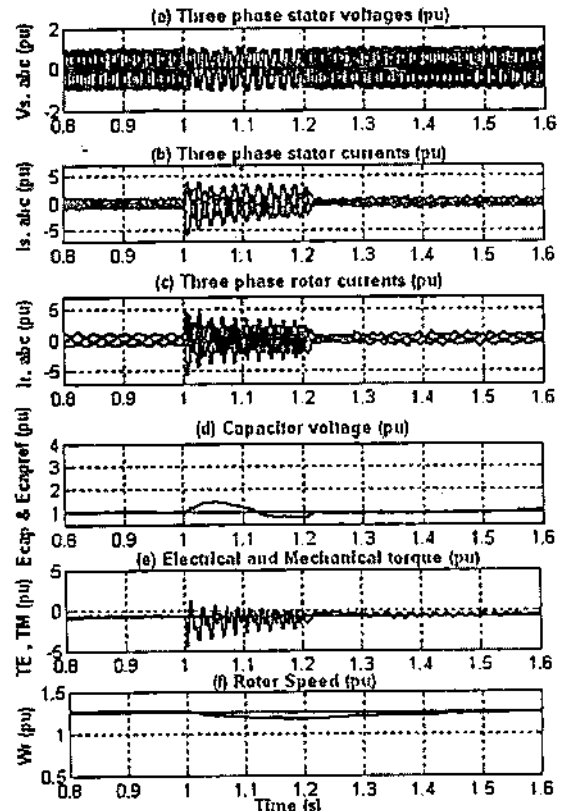

Fig .11 single phase fault with voltage dip of 0.95 p.u. on the faulty phase for 0.2 s without protection.

For unsymmetrical faults the torque and speed fluctuations are higher than that of symmetrical fault so have higher mechanical stress on wind turbine due to high torque fluctuations.

In the next section the performance of the different protection methods, Crowbar, DC Chopper, SDR and combinations of them will be evaluated.

B. Performance with Crowbar

Crowbar is commonly used to protect converters and the DFIG during voltage dips, it will operate from the beginning of fault until it's cleared. The Crowbar protects the IGBTs and the DFIG from the overcurrents during the low voltage fault event, also it protects the IGBTs from overvoltage as the RSC was switched off and rotor currents pass through the

Crowbar instead passing through the DC link as shown in Fig. 12. The results show that the DC link voltage will increase due to the operation of the freewheeling diodes. This finding coincides with other researcher's findings [10].

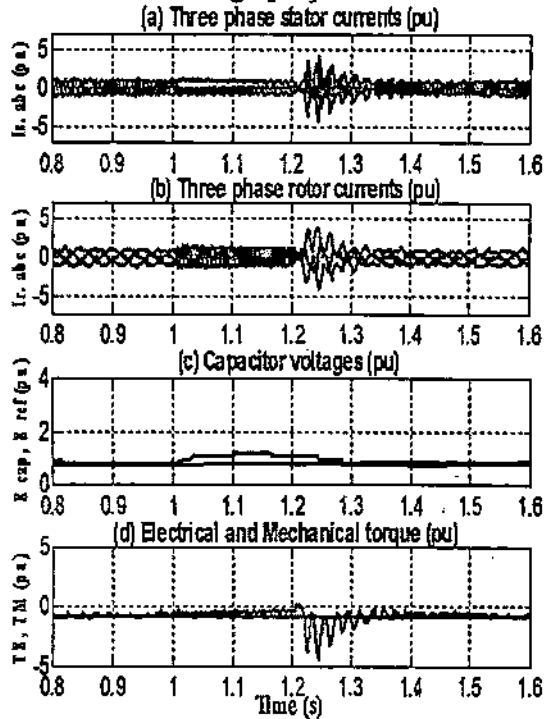

Fig. 12 three phase fault with 0.95 p.u. voltage dips for 0.2 s with Crowbar protection.

C. Performance with DC Chopper

When using DC chopper to protect the power converters and the DFIG during voltage dips, it will operate from the beginning of fault until it's cleared. It was found from the test simulations that the DC chopper protects the IGBTs from the overvoltage, but it has no effect on overcurrents and torque fluctuation during the low voltage fault as shown in Fig. 13. So this protection is a primary protection for the DC link overvoltage.

D. Performance with SDR

The SDR protection is relatively new technique for DFIG protection during low voltage events. The protection algorithm operates as follow: when a fault occurs and leads to a voltage dip on the terminal of the DFIG, a signal will be sent

to the SDR protection scheme to connect the SDR resistors in series with the rotor by switching off the bypass back to back thyristors. When the fault is removed the resistor is removed from service by the bypass thyristors.

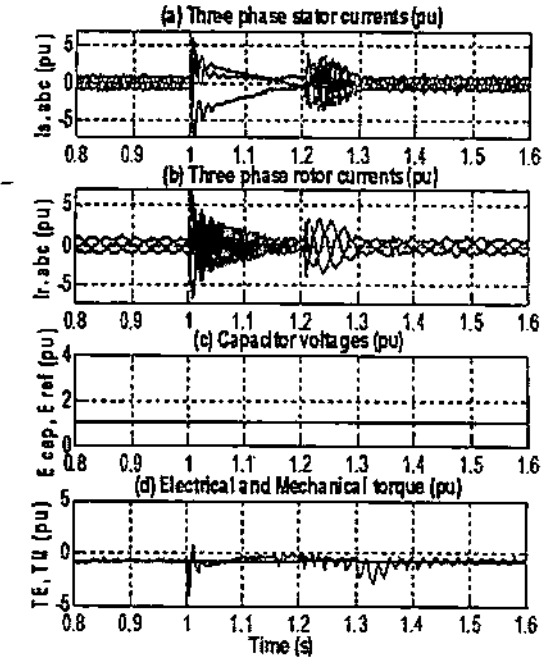
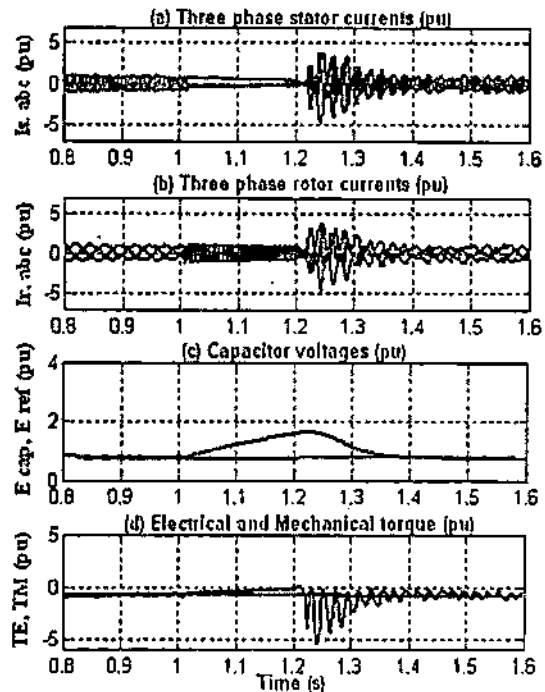

Fig.13 three phase fault with 0.95 p.u. voltage dip for 0.2 s with DC Chopper protection.



Figs .14 three phase fault with 0.95 p.u. voltage dip for 0.2 s with SDR protection.

It was found from the simulations as shown in Fig.14 that the SDR protects the IGBTs and the DFIG from the

overcurrents, but the DC link voltage increases by significant value, and this is because the rotor currents with SDR protection pass through the DC link during the fault leading to the capacitor charging.

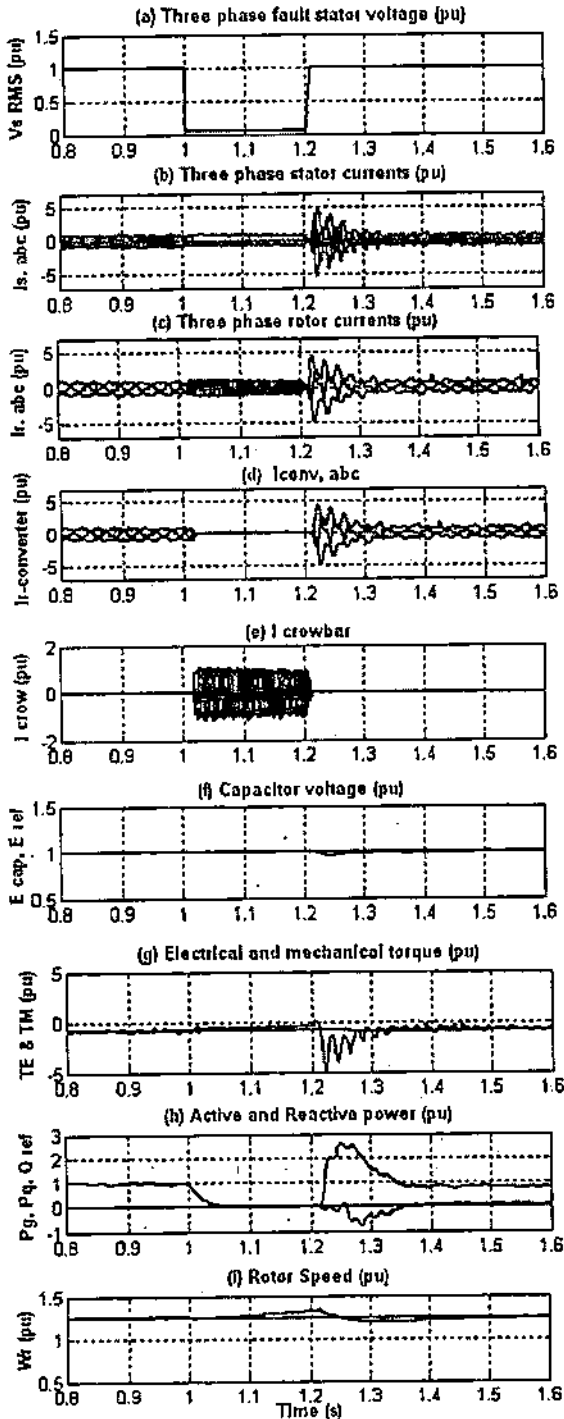

Fig. 15 Three phase fault with 0.95 p.u. voltage dip for 0.2 s with crowbar and DC Chopper protection.

This DC overvoltage may damage the IGBTs of the RSC and GSC, so the SDR can't protect the converter from

overvoltages, and it can't be used individually as overall protection scheme.

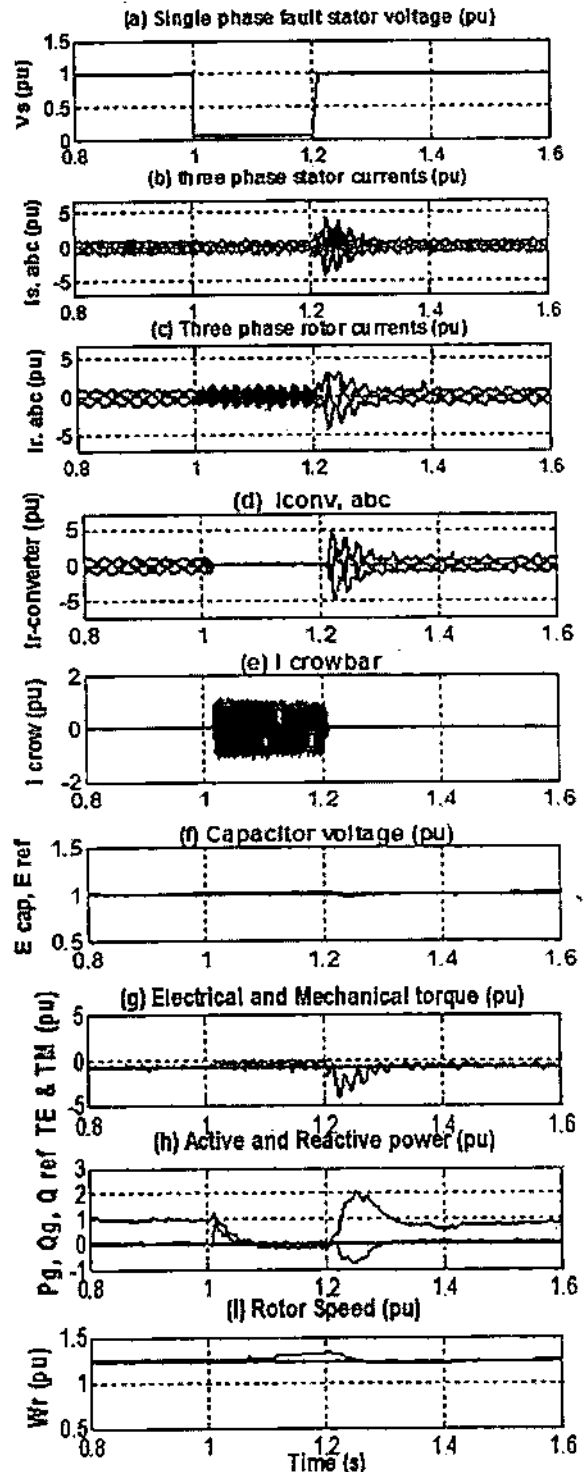

Fig. 16 single phase fault, with 0.95 p.u. voltage dip for the faulty phase for 0.2 s with crowbar and DC Chopper protection.

E. Hybrid Protection technique using Crowbar and DC chopper

Crowbars are commonly used to protect the power converters during voltage dips.

When crowbar is activated during the faults the RSC will be switched off, so the generator in this case work as single fed induction generator (SFIG) and the machine is out of control as the active and reactive power are not be controlled and this is the disadvantage of the Crowbar protection [11-12]. Also, the DFIG absorbs reactive power from the grid.

It was found from the simulation results for three phase fault that the overcurrents of the stator and rotor are damped and the RSC overcurrent was reduced as it was switched off during the fault as shown in Fig. 15. We can see that the rotor currents will pass through the crowbar during the fault. Also the DC link overvoltage was damped and smoothed by the DC Chopper, and the torque fluctuation at the beginning of the fault was greatly reduced

To make sure that the proposed protection technique is effective, it was tested under unsymmetrical single line to ground fault. The simulation results are shown in Figure 18. The results show that the stator, rotor overcurrents are damped and the converter overcurrents are reduced. Also the torque ripples in the beginning of the fault were cut down and the DC voltage was smoothed by the DC Chopper so the converter is fully protected. The results show the effectiveness for both the symmetrical and unsymmetrical faults.

F. Hybrid Protection technique using SDR and DC chopper

This protection technique combines two techniques the SDR and the DC chopper. The advantage of this proposed protection scheme is that the RSC will not switched off during the fault and the generator output active and reactive power can be still controlled.

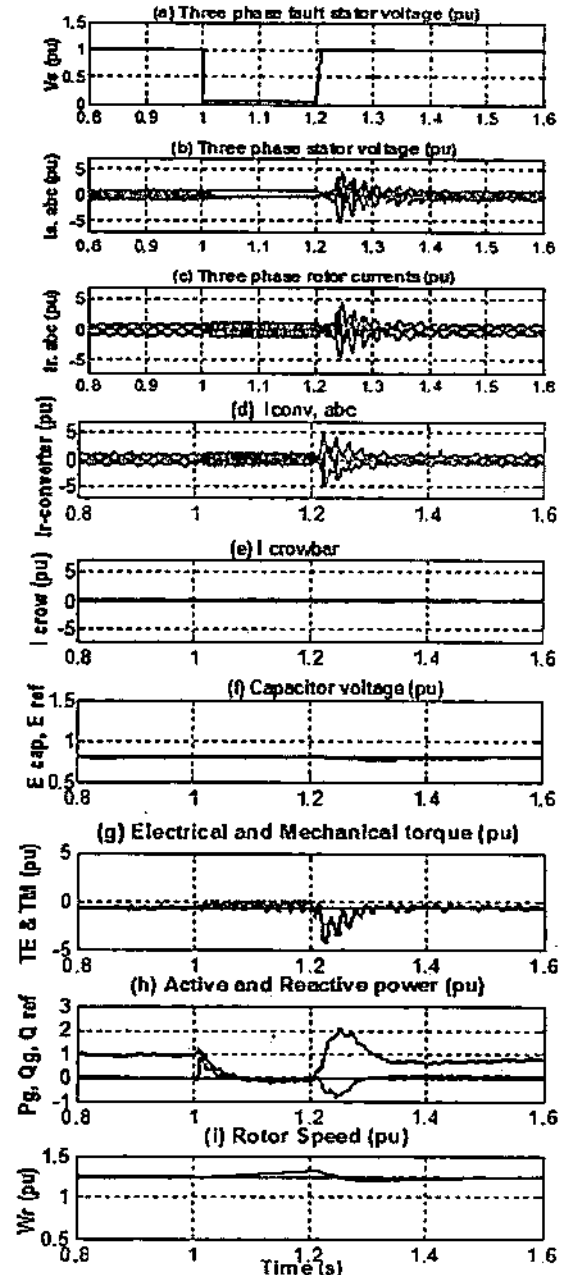

Fig.17 Three phase fault with 0.95 p.u. voltage dip for 0.2 s with SDR and DC Chopper protection.

By using this technique the generator works as DFIG under fault condition instead of operating as SFIG with Crowbar protection.

The simulation results shows that the overcurrents of the stator, rotor and the RSC are damped under the LV fault as shown in Figure 17.

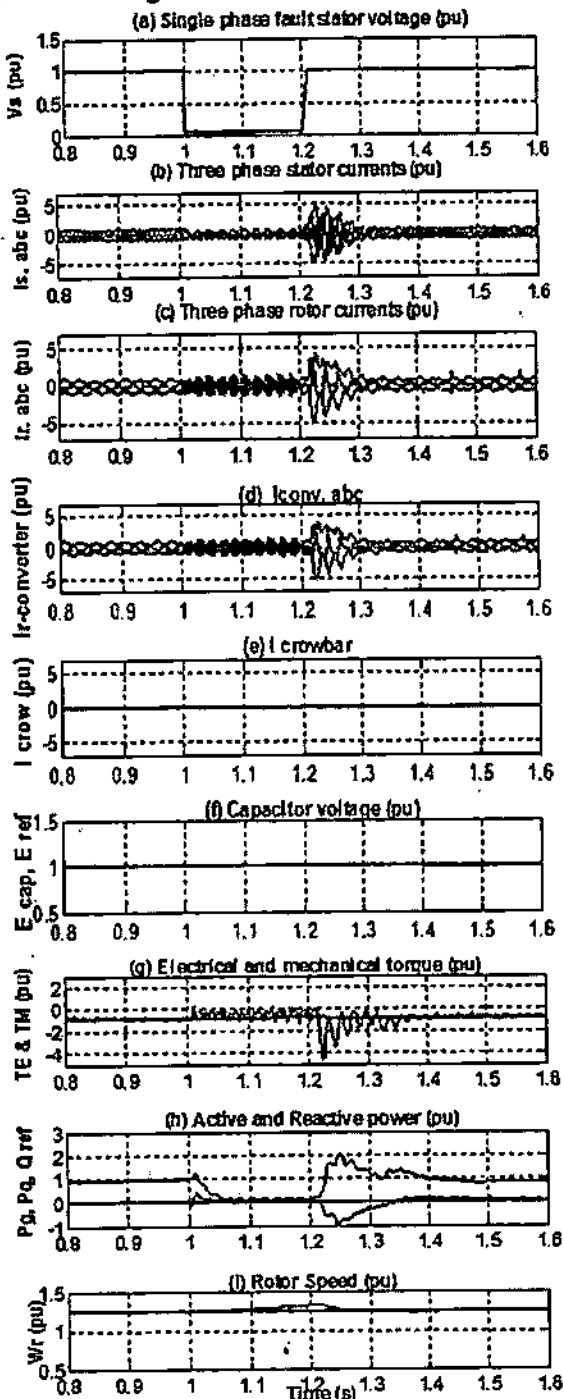

Fig.18 single phase fault with 0.95 p.u. voltage dip on the faulty phase for 0.2 s with SDR and DC Chopper protection.

The converter current will be the rotor current under LV fault in this case. Also the DC link overvoltage was damped and smoothed by the DC Chopper, and the

torque fluctuation at the beginning of the fault was reduced.

The proposed technique was tested under single phase to ground fault and the results are shown in Figure 18.

From the results it was found that the stator, rotor and converter overcurrents are damped, also the torque ripples in the begging of the fault were reduced and the DC voltage was smoothed by the DC Chopper.

The proposed protection scheme with the DC Chopper connected in parallel with the DC link and the SDR connected in series with the rotor will provide a similar Crowbar with DC Chopper performance for the DFIG under LV faults.

G. LVRT Hybrid techniques performance comparison

The performance of DFIG with the two hybrids proposed protection systems were compared. It was found from simulation results for three phase fault with 0.5 (p.u) voltage dip that the DFIG with crowbar protection absorbs reactive power as the RSC was switched off and the generator worked as single fed induction generator (SFIG), but in the case of the SDR protection no reactive power absorbed during the fault as the RSC was not switched off as shown in Fig. 19. This mean that with the SDR based scheme the machine can generate its own reactive power during the fault. This will improve the LVRT capability of the unit. Also the speed peak value with SDR is lower than speed peak value with Crowbar protection. But with the SDR the torque peak value is little more than torque peak value with

Crowbar protection, and this is due to increased series rotor winding resistance with the SDR protection.

The main disadvantage of Crowbar based scheme is loss of control of the DFIG that lead to reactive power absorption from the grid, and the increase in the rotor speed. The main advantage of the Crowbar based scheme is the lower increase in the torque ripples in comparison with SDR.

The main advantage of the SDR based scheme is the ability to control the DFIG during faults by keeping RSC which enable the generator to generate reactive power, and also lower rotor speed overshooting. The main disadvantage of this technique is that a torque fluctuation is higher than that with the Crowbar protection. So in general the SDR protection method has a better performance with various grid faults, and this method can be an effective alternative to the Crowbar protection in the industrial environment. DC Chopper is proposed to be used in combination with Crowbar or SDR for smoothing the DC link voltage.

V. Conclusion

In this paper five low voltage protection schemes for DFIG were simulated and evaluated using PSCAD. This includes DC Chopper, crowbar, SDR LVRT techniques along with two hybrid LVRT techniques.

It was found that DC Chopper can't be used individually to protect DFIG, because it cannot limit the overcurrents during the LV events, but it can be used only to smooth the DC link voltage during the low voltage event. The Crowbar protection which is the most preferred LV protection technique by manufacturers has good LVRT performance including damping of the overcurrents, and torque fluctuations. Its main drawback is that the DFIG absorbs reactive power from the grid during low voltage events. The SDR protection scheme has better LVRT performance than the Crowbar protection scheme and it reduce the need for reactive power from the grid. The disadvantage of the technique is the small increase in the torque fluctuations during the fault. SDR method can be the best alternative protection scheme for the Crowbar protection circuit.

APPENDIX

Table 1 generator parameters.

Parameter	value	Parameter	value
Rated power (MW)	2	Ratio N_s/N_r	0.3
Rated stator voltage (V)	690	Inertia constant (s)	2
Rated frequency (Hz)	50	Pole pair nom	2
Stator leakage inductance (pu)	0.1	Stator resistance (pu)	0.0054
Rotor leakage inductance (pu)	0.11	Rotor resistance (pu)	0.006
Magnetizing inductance (pu)	4		

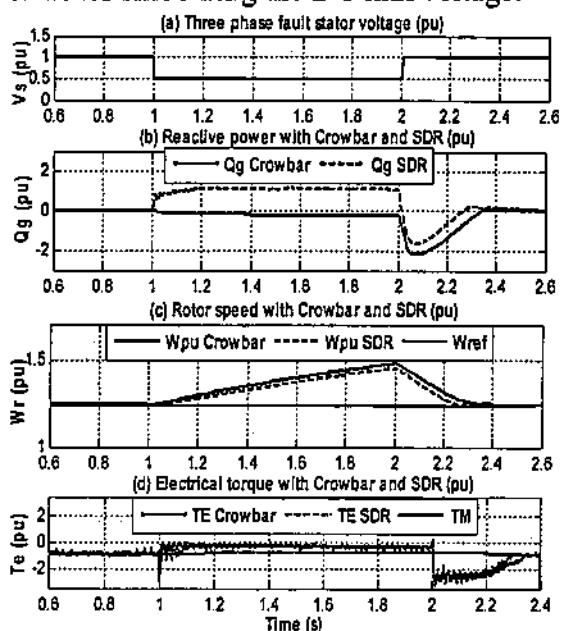

Fig. 19 Crowbar and SDR performances under three phase fault with 0.5 p.u. voltage dip for 1 second.

REFERENCES

- [1] J. Morren and S. de Haan, "Ride through of wind turbines with doubly-fed induction generator during a voltage dip," *IEEE Trans. Energy Convers.*, vol. 20, no. 2, pp. 435-441, 2005.
- [2] E.ON. Netz GmbH, Grid code for high and extra high voltage, April 2006.
- [3] J. G. Sloopweg, H. Polinder, and W. L. Kling, "Dynamic modeling of a wind turbine with doubly fed induction generator," in *Proc. IEEE Power Eng. Soc. Summer Meeting, Vancouver, BC, Canada, July 15-19, 2001*.
- [4] S. Seman, J. Niiranen, and A. Arkkio, "Ride-through analysis of doubly fed induction wind power generator under unsymmetrical network disturbance," *Power Systems, IEEE Transactions on*, vol. 21, no. 4, pp. 1782-1789, Nov. 2006.
- [5] C. Wessels and F. W. Fuchs, "Fault ride through of DFIG wind turbines during symmetrical voltage dip with crowbar or stator current feedback solution" *IEEE Energy conversion* Sept 2010.
- [6] I. Erlich, J. Kretschmann, J. Fortmann, S. Mueller-Engelhardt, and H. Wrede, "Modeling of wind turbines based on doubly-fed induction generators for power system stability studies," *IEEE Trans. Power Syst.*, vol. 22, no. 3, pp. 909-919, Aug. 2007.
- [7] I. Erlich, H. Wrede, and C. Feltes, "Dynamic behavior of DFIG-based wind turbines during grid faults," in *Proc. Power Convers. Conf, Nagoya, Japan, Apr. 2-5, 2007*.
- [8] A. Causebrook, D. J. Atkinson, and A. G. Jack, "Fault ride-through of large wind farms using series dynamic braking resistors (March 2007)," *IEEE Trans. Power Syst.*, vol. 22, no. 3, pp. 966-975, Aug. 2007.
- [9] J. Yang, John E. Fletcher, and J. O'Reilly "A Series-Dynamic-Resistor-Based Converter Protection Scheme for Doubly-Fed Induction Generator During Various Fault Conditions" *IEEE Trans. Energy. Conv*, vol. 25, NO. 2, June 2010.
- [10] Tamer Kawady, Christian Feltes, Istvan Erlich and A.I. Taalab "Protection System Behavior of DFIG Based Wind Farms for Grid-Faults with Practical considerations" *IEEE Power and Energy Society General Meeting* 2010.
- [11] D. Xiang, L. Ran, P. J. Tavner, and S. Yang, "Control of a doubly fed induction generator in a wind turbine during grid fault ride-through," *IEEE Trans. Energy Convers.*, vol. 21, no. 3, pp. 652-662, 2006.
- [12] G. Pannell, D.J. Atkinson, and B. Zahawi "Minimum-Threshold Crowbar for a Fault-Ride-Through Grid-Code-Compliant DFIG Wind Turbine" *IEEE Trans. Energy. Conv*, vol. 25, NO. 3, September 2010.