

EFFECT OF TAILDEPTH VARIATION ON COMBINED DISCHARGE OVER WEIRS AND BELOW GATES

تأثير تغير العمق الخلفي على السريان الآتي فوق الهدارات وأسفل البوابات

A.M. AL-Brahim¹, A.M. Negm² and A.A. Ibrahim³

¹ Associate Prof., Civil Engineering Dept., College of Engineering,
King Saud University, P.O.Box 800, Riyadh 11421.

² Associate Prof., Water & Water Structures Engineering Dept.,
Faculty of Engineering, Zagazig University, Egypt.

³ Assistant Prof., Water & Water Structures Engineering Dept.,
Faculty of Engineering, Zagazig University, Egypt.

المستخلص:

في هذا البحث تم دراسة تأثير تغير عمق المياه الخلفي على السريان الآتي فوق الهدارات وأسفل البوابات. وقد استخدم لذلك ١١ نموذج معلمي بأبعاد مختلفة حيث تم اختبار كل نموذج تحت ظروف سريان مختلفة وتحت أعماق خلفية متغيرة. وقد استخدمت قناة معملية قابلة للميل حيث اختبرت جميع النماذج تحت تأثير ثلاثة ميول (أفقي، ميل معتدل، وميل منحد). وبطبيعة الحال وجد تأثير واضح للميل على العمق الخلفي وكذلك على معامل التصريف. وقد تبين من الدراسة أن العمق الخلفي له قيمة معينة يظهر بعدها تأثيره على السريان الآتي حيث كلما زاد العمق الخلفي يقل الجريان ويظهر زيادة في العمق الأماسي كلما زاد العمق الخلف لذات التدفق. وأظهرت نتائج الدراسة أن الحصاة الكبرى من السريان الآتي إنما ترجع إلى السريان أسفل البوابة. هذا وقد توصل البحث إلى معادلة لحساب العمق الخلفي الذي بعده مباشرة فإن أي زيادة فيه تؤثر على السريان الآتي. كما توصل البحث إلى معادلة تجريبية غير بعدي لحساب التصريف الآتي باستخدام الأساليب الإحصائية بدلالة المتغيرات المختلفة للسريان و الأبعاد الهندسية للنماذج بالإضافة إلى شمولها على الحد الأقصى للعمق الخلفي (للسريان الحر).

ABSTRACT

Recently, both the free and the submerged flow through combined weir and gates were analyzed. But the flow in the zone between free and submerged flow has not analyzed yet. This paper presents the results of an experimental investigation to study the effect of varying tailwater depth on the characteristics of the combined flow over contracted sharp crested rectangular weirs and below contracted rectangular gates of sharp edges. The experiments were carried out in a flume using various geometrical dimensions under different flow conditions. The effects of both flow and geometrical parameters are discussed and presented in graphical form. The dimensional analysis principles were employed to correlate the combined discharge to the geometry and flow parameters. The experimental data were then used to develop a general non-dimensional equation for predicting the discharge through the combined notch knowing its geometry and the head of water over the weir. The predicted discharges agreed well with the experimental ones.

INTRODUCTION

Gates and weirs are used extensively to control and measure water flows in open streams. Many works have been dealt with the use of sluice gate in discharge measurements such as Henry [1], Rajaratnam and Subramanya [2], Rajaratnam [3], Subramanya [4]. Swamee [5] developed a generalized discharge equation for the sluice gates based on Henry's curves. One disadvantage of the sluice gates is the retaining of the floating materials behind the gate. This can be overcome by providing an opening in the top of the gate thus allowing simultaneous underflow and overflow conditions. Concerning the flow over weirs, many works have been found in the literature such as Ackers, et al. [6], Bos [7], Kindsvater and Carter [8], and Swamee [9]. Some of these works discussed the specifications and the proper ways of installing and using weirs in flow measurements, BSI [10], USBR [11]. Many problems concerning sedimentation and depositions could be minimized by combined weirs and gates flow, Alhamid, et al. [12].

Few works dealing with the combined overflow and underflow as flow measurement devices are available in the literature [13-23]. Negm, et al. [14] discussed the characteristics of the combined flow over rectangular contracted weirs and below inverted triangular weirs. In 1995, El-Saiad, et al [15] investigated the effect of the angle of a triangular opening when it is used above and below the rectangular opening. They found that the use of a triangular opening above a rectangular one is more efficient than the reversed case for different angles. Alhamid, et al. [16] presented regression equation to predict the flow passing over contracted rectangular weir and below triangular gates. Negm [17] analyzed the characteristics of the combined free flow over contracted weirs and below contracted gates of rectangular shape with unequal contractions. A discharge prediction model for combined flow over suppressed rectangular weirs and below gates was presented by Negm [18]. Negm, et al. [19] discussed the effect of downstream submergence on the combined flow and presented discharge prediction equations for triangular weir above rectangular contracted gates and contracted rectangular weir above triangular gate. The combined free flow over weirs and submerged flow below gates of unequal contractions was investigated by Negm [20]. Recently, Alhamid [21] provided an equation for predicting the combined free and submerged flow through the combined V-notch-gate device to overcome some of the deficiencies of the developed equation by Alhamid et al. [12].

The characteristics of free flow through combined rectangular weir and below gates are discussed by Al-Brahim, et al. [22] while those of the combined submerged flow are analyzed by Negm, et al. [23]. In this study the transition from free flow to submerged flow is discussed. This means that the effect of tailwater depth variation on the flow characteristics is analyzed. One aim of this study is to provide a relationship between the tailwater depth beyond which the submergence ratio affects the combined flow. Also, empirical equations are provided to estimate the combined discharge in terms of geometry and flow parameters.

2. THEORETICAL BACKGROUND

Figure (1) shows a definitions sketch for the free flow over contracted sharp crested weir and below contracted rectangular gate of sharp edges. The flow equation for the contracted sharp crested weir is given by [4]:

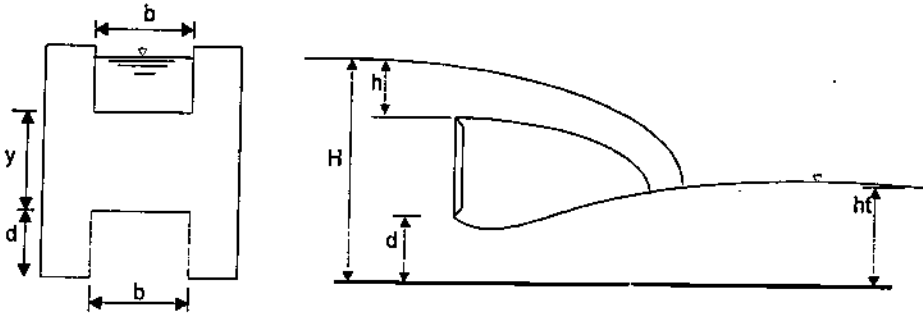

Figure 1. Definition sketch for combined flow over weirs and below gates

$$Q_w = \frac{2}{3} C_w \sqrt{2g} (b - 0.1nh) h^{1.5} \quad (1)$$

Where Q_w is the discharge passing over the weir, h is the head over the weir measured upstream the weir at about 40 cm, C_w is the coefficient of discharge of the weir, b is the width of the weir crest, n is the number of side contraction, and g is the acceleration due to gravity.

Also, the flow equation for the gate of sharp edges can be written as [2]:

$$Q_g = C_g b d \sqrt{2g} \sqrt{(d + y + h)} \quad (2)$$

Where Q_g is the flow rate under the gate, b is the gate width (which is the same for the weir), C_g is the coefficient of discharge for the gate, d is the gate opening, and y is vertical distance between the gate top and the weir bottom.

Assuming that one coefficient of discharge, C_d , can be applied for the combined flow. Adding Eq. (1) to Eq. (2), the discharge equation for the combined flow may be expressed as:

$$Q_c = C_d b d \sqrt{2g} \sqrt{(d + y + h)} + \frac{2}{3} C_d \sqrt{2g} (b - 0.2h) h^{1.5} \quad (3)$$

Q_c is the combined flow over the weir and below the gate

which can be rewritten as:

$$\frac{Q_c}{\sqrt{2gb}d^{1.5}} = C_d \left\{ \frac{1}{1} \sqrt{\left(1 + \frac{y}{d} + \frac{h}{d}\right)} + \frac{2}{3} \left(1 - 0.2 \frac{h}{b}\right) \left(\frac{h}{d}\right)^{1.5} \frac{1}{1} \right\} \quad (4)$$

On the other hand, the dimensional analysis is employed and the following equation is derived:

$$\frac{Q_c}{\sqrt{2gb}d^{1.5}} = f\left(\frac{H}{d}, \frac{h}{d}, \frac{y}{d}, \frac{h}{b}, \frac{b}{d}, \frac{b}{B}\right) \quad (5)$$

Eqs. (4) and (5) are valid for free flow. In order to take the effect of tailwater depth on the combined flow, Equation (5) should contain the tailwater depth-gate opening ratio, h_t/d (the submergence ratio). Also, the bottom slope, S_o , should be included to enable the study of the effect of the bottom slope on the tailwater depth variation. Therefore, Eq. (5) becomes:

$$\frac{Q_c}{\sqrt{2gb}d^{1.5}} = f\left(\frac{H}{d}, \frac{h}{d}, \frac{y}{d}, \frac{h}{b}, \frac{b}{d}, \frac{b}{B}, \frac{h_t}{d}, S_o\right) \quad (6)$$

3. EXPERIMENTAL SET-UP

Experiments were conducted in a glass sided tilting flume of 9 m long working section. The flume bed width as well as the maximum allowed water depth is 305 mm. Water depths were measured by means of point gauges. Discharge was measured by a pre-calibrated V-notch installed in a measuring tank located below the outlet of the flume. The flume is equipped with a tailgate to control the tailwater depth variations.

Nine combined flow models were tested. An additional two models were considered, one model for the gate flow only and another model for the weir flow only, to discuss the relative contribution of gate flow and weir flow to the combined flow. Model dimensions and model dimensionless parameters are given in Table (1). Models are made from Plexiglas sheet of 10 mm thick beveled from all the edges at 45° with sharp edges of thickness 1 to 2 mm. The sides of the models are provided with rubber sheets to prevent leakage. Models are fixed to the flume using Plexiglas supports. Tests are carried out in a flume at horizontal bed. The selection of model materials and flume slopes is based on the available facilities.

In each test, flow rate, Q_c , upstream depth, head over the weir, h , and the tailwater depth, h_t , are measured under free flow conditions. The position of the tailgate is changed to increase the tailwater depth. Waiting for stability conditions, the tail and upstream water depths are measured again each time the gate is changed. When the flow conditions upstream the weir/gate starts to be controlled by the downstream flow, the tailwater depth and the upstream depth are measured. This final tailwater depth is termed the limiting tailwater depth.

Table 1 Dimensions of the models

Model	.b cm	.y cm	.d cm	b/d	y/d	b/B	Remarks
1	9.75	7.0	15	0.65	0.47	0.330	CF*
2	10.0	5.0	10	1.00	0.50	0.330	CF
3	20.0	5.0	7	2.86	0.71	0.660	CF
4	20.0	10.0	10	2.00	1.00	0.660	CF
5	20.0	7.0	5	4.00	1.40	0.660	CF
6	16.0	15.0	10	1.60	1.50	0.525	CF
7	16.0	10.0	5	3.20	2.00	0.525	CF
8	16.0	15.0	7	2.29	2.14	0.525	CF
9	10.0	15.0	7	1.43	2.14	0.328	CF
10	20.0	0	10	2.00	-	0.660	GF
11	20.0	20.0	0	-	-	0.660	WF

* CF=combined flow, GF=gate flow alone and WF=weir flow alone

4. DISCUSSIONS AND ANALYSIS OF RESULTS

4.1 Combined Discharge Coefficient

Equation (4) may be used to predict the combined discharge in terms of four parameters, h/d , h/b , y/d and C_d provided that the assumption of one C_d for both gate and weir is valid. Therefore, it is important to check the validity of assuming same C_d for weir and gate. Figure (2) presents the typical results of testing model No. 4 for combined flow ($b/d=2$, $y/d=1$) and models No.10 for weir flow ($b=20$ cm) alone and No. 11 for gate flow ($b=20$ cm and $d=10$ cm) alone. This figure highlights the nature of the combined discharge coefficient, C_d . It is observed that combined C_d is closer to the gate discharge coefficient, C_g , than that of the weir, C_w . This can be explained by the fact that the contribution of the gate discharge to the combined discharge is more than that of the weir. This fact is well demonstrated by Figure (3) that shows the variations of discharge with the upstream head ratio (H/b) for the three cases of combined flow, gate flow and weir flow. The variations of Q and H seem to be linear (which is not true). This is because the range of H tested in this work is small (according to the test flume and models facilities). From figures (2) and (3) it may be deduced that the average C_d can not be used directly in Eq.(4) to predict the combined discharge as this will result in

underestimation of the weir flow. The average value of C_d is 0.5707, 0.5770 and 0.5838 for bottom slopes of 0.0, 0.77% and 1.161% respectively. Inserting these values in Eq.(4) and comparing the calculated values with measured, a maximum error of 10% is obtained and higher than 10% in few cases. This result corporates with that obtained by Negm et al. [16]. For this reason the regression analysis is used to correlate the combined C_d with the parameters of Eq.(6a):

$$C_d = f\left(\frac{h}{d}, \frac{H}{b}, \frac{y}{d}, \frac{h}{b}, \frac{b}{d}, \frac{b}{B}, \frac{h}{d}, S_o\right) \tag{6a}$$

The following equation is obtained:

$$C_d = C_o + C_1 \frac{H}{d} + C_2 \frac{H}{b} + C_3 \frac{h}{d} + C_4 \frac{y}{d} + C_5 \frac{b}{d} + C_d \frac{b}{B} \tag{7}$$

where the coefficients of Eq.(7), the coefficient of determination, R^2 , and the standard error of estimate, SEE, are given in table (2) for different slopes:

Table 2. Coefficient of Eq.(7)

C_o	C_1	C_2	C_3	C_4	C_5	C_6	R^2	SEE	S_o
0.1866	0.1775	0.0353	-0.1406	-0.1811	0.0066	0.1947	0.9230	0.0086	0.0
0.3378	0.1077	0.0153	-0.0627	-0.1040	-0.0018	0.1303	0.9106	0.0094	0.77%
-0.0526	0.4054	0.0414	-0.3706	-0.4132	0.0140	0.2094	0.8793	0.0112	1.161%

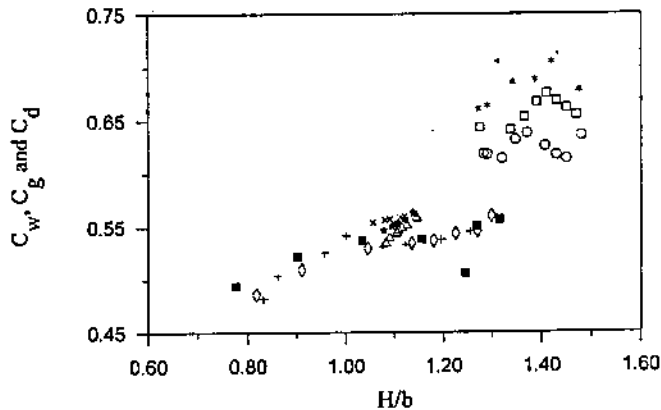

Figure (2) Typical variation of C_d with H/b for gate flow (○) $S_o=0\%$, (+) 0.77%, (■) 1.161%, weir flow (○) 0%, (□) 0.77%, (*), 1.161% and combined flow ($b/d=2, y/d=1$) (Δ) 0%, (★) 0.77%, (×) 1.161%.

Figures (4a), (5a) and (6a) show the measured combined discharge coefficient versus the prediction of Eq.(7) for bottom slopes of $S_o=0.0, 0.77\%$ and 1.161% respectively. These figures show good agreement between the measured discharge coefficient and the predicted ones with maximum absolute error equals to 3%. Figures (4b), (5b) and (6c) that presents the predicted discharges using Eq.(7) and (4) for $S_o=0.0, 0.77\%$ and

1.161% respectively versus the observed ones. These figure show good agreement between predicted and measured results with maximum absolute error equals to 3%.

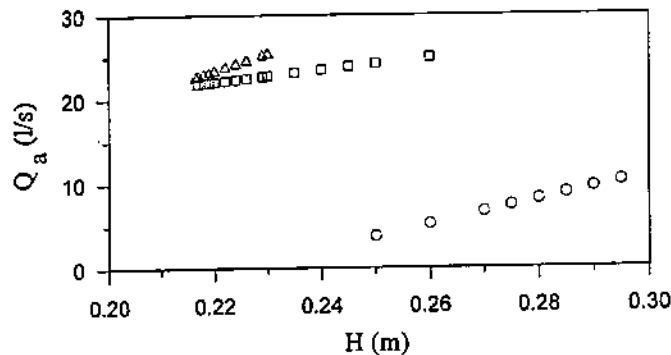

Figure (3) Typical variation of Q with H for gate flow (\square), weir flow (\circ) and combined flow (Δ), ($b/d=2$, $y/d=1$).

4.2 Effect of Taildepth Variations on Flow Parameters

It is known that the taildepth has no effect on the discharge characteristics of the gate or the weir when the flow through them is free flow. Consequently, the upstream flow depth is not affected. Increasing the taildepth yields backwater effect that increases the depth of flow downstream the combined flow system. When the flow depth downstream the combined weir-gate-device just exceeds the gate opening depth, d , the flow is termed submerged flow. Any further increase in the taildepth will lead to further increase in the depth just downstream the gate. In turn this will affect the upstream depth by increasing it at the same d discharge due to the transfer of the energy from kinetic energy to pressure energy [19]. These discussions can be easily noted from the variations of h/d with h/d for different Q_T as in Figure (7). This figure shows that for the same Q_T , h/d is constant upto a certain value of h/d . Beyond which, h/d increases with the increase of h/d . This value of h/d is the maximum limit of free flow. Any further increase in it, the flow becomes submerged and the upstream head ratio is affected. This limiting h/d is being fixed for each model and is independent of the flow parameters as can be seen from Figure (7). The variations of h/b with h/d show the same trend as in Figure (7) because for any particular model, b and d are fixed and hence the data for any Q_T will be only shifted up or down according to the relative dimensions of b and d . The analysis of all the data shows that the limiting tailwater depth ratio, h/d , varies between 1 and 3.5 for the range of the tested models in the present study.

4.3 Effect of Bottom Slope on h/d .

It was observed that h/d increased with the increase of Q_T at particular bottom slope as shown from Figure (8). This figure indicates also that the increase of the bottom slope increases h/d at the same Q_T .

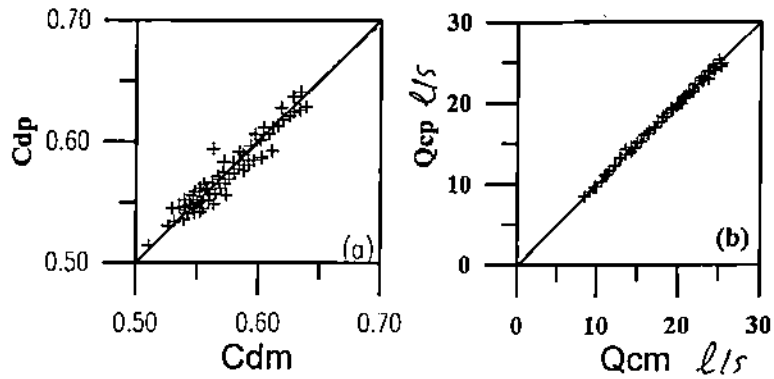
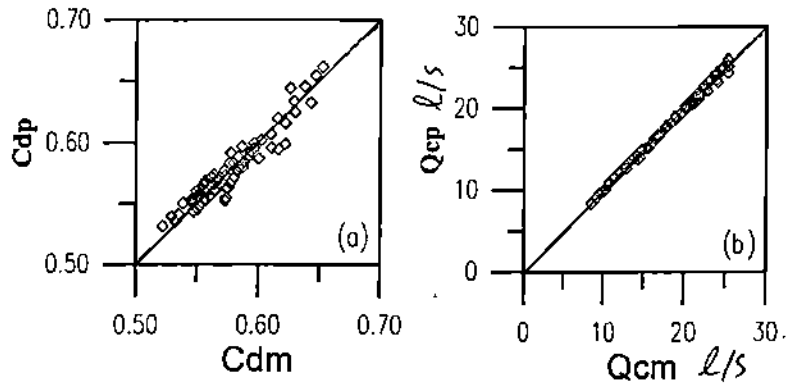

Figure (4): Measured values versus prediction for (a) Cd and (b) Qc, for $S_o=0.0$, m =measured and p =predicted, Eq.(7)



Figure(5) Measured vaues versus predicted ones for (a) Cd and (b) Qc, for $S_o=0.77\%$, m =measured and p =predicted, Eq.(7)

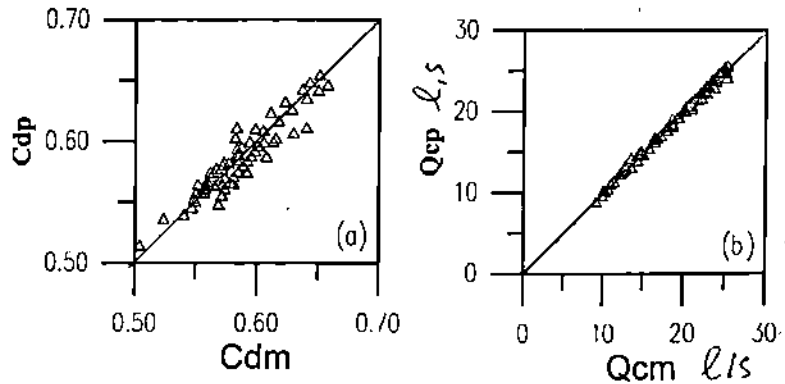

Figure (6) Measured values versus predicted ones for (a) Cd and (b) Qc, for $S_o=1.61\%$, m =measured and p =predicted, Eq.(7)

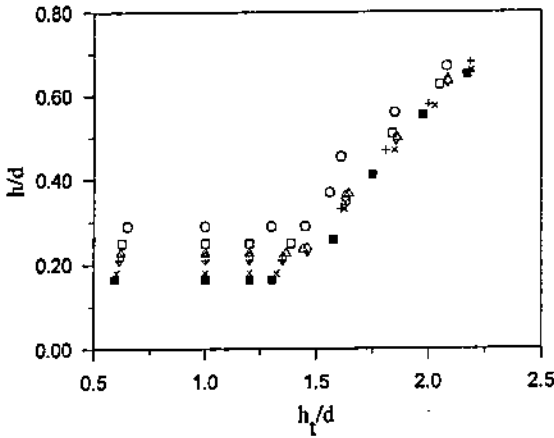

Figure (7) Typical variation of h_t/d with h_b/d for different Q_T for $b/d=2, y/d=1, (O) Q_T=0.9031, (\square) 0.8746, (\Delta) 0.8603, (\circ) 0.8496, (+) 0.8460, (x) 0.8246$ and $(\blacksquare) 0.8103$.

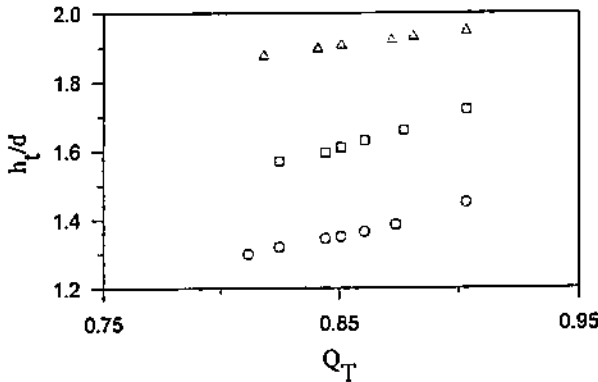

Figure (8) Typical variation of h_t/d with Q_T for different bed slopes at $b/d=2, y/d=1, (O) S_0=0\%, (\square) 0.77\%$ and $(\Delta) 1.161\%$.

4.4 Estimation of the Limiting h_t/d for Free Flow

It is possible to predict the limiting tailwater depth ratio, h_t/d , beyond which the flow becomes submerged (and the flow characteristics is affected) using different flow and geometry parameters. The data of the 9 models of table (1) are used through multiple linear regression analysis. Eq.(8) is found to fit the data well with coefficient of determination of ($R^2 = 0.952$) and standard error of estimate of ($SEE = 0.143$).

$$\frac{h_t}{d} = -0.1447 + 0.9877Q_T - 0.435\frac{h}{d} + 0.1693\frac{h}{b} + 0.1571\frac{y}{d} + 34.3864S_0 + 0.2929\frac{b}{d} \quad (8)$$

The prediction of Eq. (8) is shown in Figure (10) compared to the experimental data.

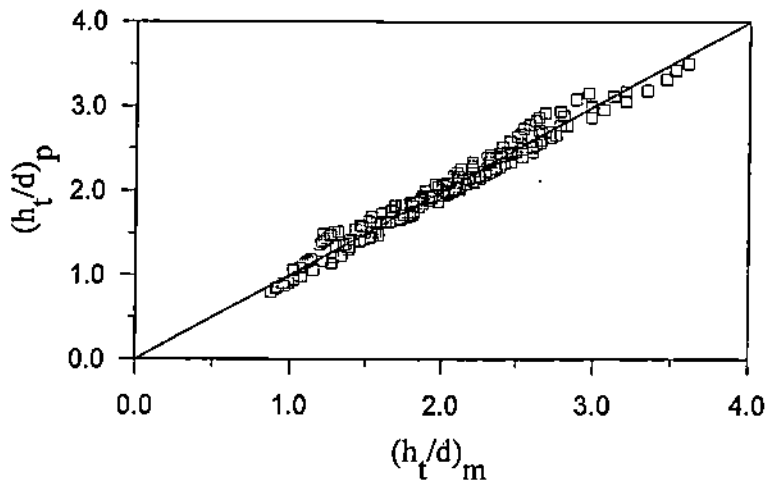

Figure (9) Comparison between measured and estimated values of h/d using Eq. (8), m for measured and p for predicted.

4.3 Estimation of Discharge

Based on Eq. (6), the correlation and the multiple linear regression analysis are used to correlate the non-dimensional discharge both the flow and geometry parameters. Several trials are attempted using all the parameters of Eq.(6) and using subsets of them. The insignificant parameters are excluded from the regression analysis. The following equation is found to fit the data well.

$$\left(\frac{Q_c}{\sqrt{2gbd^{1.5}}} \right) = 0.5298 + 0.5628 \left(\frac{h}{d} \right)^{1.35} - 0.0077 \left(\frac{h}{b} \right) + 0.1459 \left(\frac{y}{d} \right) + 0.0679 \left(\frac{h_t}{d} \right) \quad (9)$$

Eq. (9) have R^2 of 0.997 and SEE of 0.0286. As can be seen from the coefficients of the different terms in Eq. (9), the contributions of h/d and y/d to Q_T are major while that due to h/b and h_t/d are minor. The comparison between the predicted values (Q_{TP}) using (9), with the measured values (Q_{Tm}) is presented in Figure (9). This figure shows close agreement between the observed and the predicted values. Eq. (9) is an empirical equation and is valid within the following limitations:

$0.47 \leq y/d \leq 2.14$, $0.65 \leq b/d \leq 4$, $0.9 \leq h/d \leq 3.7$, $1 \leq h_t/d \leq 3.5$, $h > 0$ and $d > 0$.

When $h=0$ the flow is due to gate alone and the when $d=0$ the flow will be due to weir only. In both cases, Eqs.(8) and (9) are not valid and the developed equations for both devices and presented in the review [2,3,6,7,8,11] can be used.

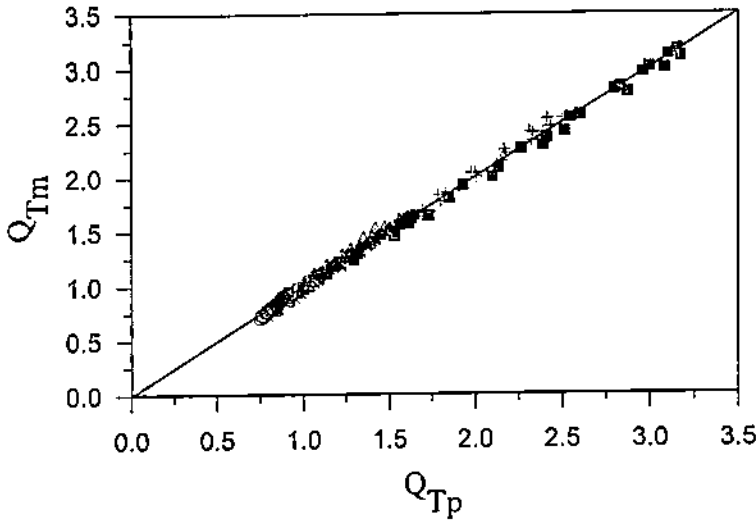

Figure (10) Comparison between measured and estimated Non-dimensional discharge term using Eq. (9), (O) $b/d=0.65$, $y/d=0.47$, $b/B=0.32$, (\times) 1, 0.5, 0.33, (Δ) 2.86, 0.71, 0.66, (\diamond) 2, 1, 0.66, (+) 4, 1.4, 0.66, (\square) 1.6, 1.5, 0.53, (\blacksquare) 3.2, 2, 0.5, (\star) 2.29, 2.14, 0.53 and (\times) 1.43, 2.14, 0.33.

5. CONCLUSIONS

An experimental investigation is conducted to study the effect of taildepth variation on flow characteristics through combined weir-gate device. It is observed that none of the flow characteristics is affected by increasing the taildepth for free flow range. The flow characteristics begins to change when the depth just downstream the device exceeds the gate openings. The submergence ratio may have a value of more than 1.0 without affecting the free flow characteristics depending upon the model geometrical parameters b/d and y/d . It is observed that as the bottom slope increases the limiting submergence ratio increases. The regression analysis is used to correlate the limiting submergence to the flow and geometrical parameters and Eq. (8) is developed to estimate h/d . Also, Eq.(9) can be used to estimate the combined discharge in terms of h/d , h/b , y/d and h_1/d . Both of Eqs.(8) and (9) are only valid within the following limitations: $0.47 \leq y/d \leq 2.14$, $0.65 \leq b/d \leq 4$, $0.9 \leq h/d \leq 3.7$, $1 \leq h_1/d \leq 3.5$, $h > 0$ and $d > 0$.

REFERENCES

- [1] Henery, H.R., "Discussion of diffusion of submerged jets", by M.L. Albertson, Y.B. Dai, R.A. Jensen, and H. Rouse, Trans. ASCE, Vol.115, pp.687-694, 1950.
- [2] Rajaratnam, N., and Subramanya, K., "Flow equation for the sluice gate", Proc. ASCE, J. Irrigation and Drainage Engineering Div., Vol 93, No. IR3, paper No. 5436, pp. 167-186, 1967.

- [3] Rajaratnam, N., "Free flow immediately below sluice gates", Proc. ASCE, J. Hydraulic Engineering Div., Vol 103, No. HY4, pp. 345-351, 1977.
- [4] Subramanya, K., "Flow in open channels", Tata McGraw-Hill Publishing Company Ltd., New Delhi, First revised edition, pp.219-226, 1986.
- [5] Swamee, P.K., "Sluice-gate discharge equations", Proc. ASCE, J. Irrigation and Drainage Engineering, Vol 118, No. 1, pp. 57-60, 1992.
- [6] Ackers, A., White, W.R., Perkins, J.A., and Harrison, A.J.M., "Weirs and flumes for flow measurements", Chapter 3, John Wiley & Sons, New York, pp.44-85, 1978.
- [7] Bos, M.G., Editor, "Discharge measurement structures", Oxford & IBH publishing Co., New Delhi, pp. 34-42, 1976.
- [8] Kindsvater, C.E., and Carter, R.W., "Discharge characteristics of rectangular thin-plate weirs", Proc. ASCE, J. Hyd. div., Vol. 83, No. HY6, paper No.1453, pp 1-36, 1957.
- [9] Swamee, P.K., "Generalized rectangular weirs equations", Proc. ASCE, J. Hydraulic Engineering, Vol. 114, No. 8, pp. 945-949, 1988.
- [10] British Standard Institution (BSI), Part 4A, "Thin-plate weirs and Venturi flumes, in methods of measurement of liquid flow in open channel", BSI 3680, BSI, London, 1965.
- [11] USBR, United States Dept. of the Interior Bureau of Reclamation, "Water measurement manual", Second Edition, Denver, Col., revised reprint (1984), pp. 7-42, 1967.
- [12] Alhamid, A.A., Negm, A.M. and Al-Brahim, A.M., "Discharge Equation for Proposed Self-Cleaning Device", Journal of King Saud University, Engineering Science, Vol.9, No.1, Riyadh, Saudi Arabia, 1997.
- [13] Ahmed, F.H., "Characteristics of discharge of the combined flow through sluice gate and over weirs", J. Engineering and Technology, Iraq, Vol 3, No. 2, pp. 49-63 (in Arabic), 1985.
- [14] Negm, A.M., El-Saiad, A.A., Alhamid, A.A., and Husain, D., "Characteristics of Simultaneous Flow Over Weir and Below Inverted V-Notches", Civil Engineering Research Magazine, Civil Engineering Department, Faculty of Engineering, Al-Azhar University, Cairo, Egypt, Vol. 16, No. 19, pp. 786-799, 1994.
- [15] El-Saiad, A.A., Negm, A.M. and Waheed El-Din, U., "Simultaneous Flow Over Weirs and Below Gates", Civil Engineering Research Magazine, Civil Engineering Department, Faculty of Engineering, Al-Azhar University, Cairo, Egypt, Vol. 17, No. 7, 1995, pp. 62-71, 1995.
- [16] Alhamid, A.A., Husain, D. and Negm, A.M., "Discharge Equation for Combined Flow Over Rectangular Weirs and Below Inverted Triangular Weirs", Arab Gulf Journal for Scientific Research, Vol. 14, No.3, Riyadh, Saudi Arabia, pp.595-607, 1996.
- [17] Negm, A.M., "Characteristics of combined flow over weirs and under gate with unequal contractions", in Advances in Hydrosience and Engineering, Vol.2, Part A, (Ed. Chinese Hydraulic Engineering Society, CHES and International Research and Training Center on Erosion and Sedimentation, IRTCES),

- Proceedings of second Int. Conf. on Hydro-Science and Engineering, ICHE-95, 22-26 March, Tsinghua University Press, Beijing, China, pp. 285-292, 1995.
- [18] Negm, A.M., "Discharge Prediction Model for Simultaneous Underflow-Overflow", 6th Int. Symp. on Flow Modeling and Turbulence Measurements, Florida, USA, 8-10, Sep., Balkema Publishers, 665-670, 1996.
- [19] Negm, A.M., El-Saiad, A.A. and Saleh, O.K., "Characteristics of Combined Flow Over Weirs and Below Submerged Gates", Proceedings of Second Int. Eng. Conf., 1-3 April, Vol. III-B, Mansoura University, Mansoura, 259-272, 1997.
- [20] Negm, A.M., "Characteristics of simultaneous overflow-submerged underflow, Scientific Bulletin, Faculty of Engineering, Ain Shams University, Accepted for Publications, Vol.34, 1999.
- [21] Alhamid, A.A., Analysis and Formulation of flow through combined V-notch-gate device, Journal of Hydraulic Research, Vol 37, no.5, pp.697-705, 1999.
- [22] Al-Brahim, A.M., Negm, A.M. and Alhamid, Combined flow over weirs and below gates, Journal of Hydraulic Research, Accepted for Publications, 1999.
- [23] Negm, A.M., Salem, M.N. and Ibrahim, A.A., Characteristics of simultaneous flow over weirs and below submerged gates, Al-Matar Engineering Bulletin, Faculty of Engineering and Technology, Hellwan University, (to be published 2000).

NOTATIONS

- b width of the weir crest, (L).
- B width of flume, (L).
- C_d the discharge coefficient for the combined flow, (-).
- C_g discharge coefficient of the lower opening alone, (-).
- C_w discharge coefficient of the contracted rectangular weir alone, (-).
- d gate opening, (L).
- g acceleration due to gravity, ($L T^{-2}$).
- h the measured head over the weir, (L).
- h_d the head just downstream the gate, (L).
- h_t the maximum tail water depth for free flows conditions, (L).
- Q_c the combined flow rate, ($L^3 T^{-1}$).
- Q_T the nondimensional discharge term (T_m for measured and T_p for estimated (-).
- Q_w discharge over the suppressed rectangular weir alone, ($L^3 T^{-1}$).
- Q_g discharge below the gate alone, ($L^3 T^{-1}$).
- R^2 Multiple coefficient of determination, (-).
- S submergence ratio, y_t/d .
- y the vertical distance between the top most weir edge and the bottom most gate edge, (L).