

EXPERIMENTAL DEDUCTION OF SERIES RESISTANCE FOR VARIOUS CONFIGURATIONS OF LEAD ACID BATTERIES SUPPLIED FROM SOLAR CELLS ARRAY

الاستنتاج العملي لقيمة مقاومة التوالي لبطارية الرصاص الحامضية التي تغذي بمجموعة خلايا شمسية

By

A.M.M.Aly S.S.Eskander

Mansoura University- Faculty of Engineering- Electrical Power and Machines Department

الخلاصة

في هذا البحث يتم شحن بطاريتان متماثلتان من مجموعة خلايا شمسية. وقد تم توصيلهم مرة علي التوازي ثم علي التوالي. وقد تم مراقبة أداء البطاريتان في كل مرة وحساب قيم مقاومة التوالي للبطاريتان معا عند كل توصيلة وذلك باستخدام طريقة مقترحة وقد تم أيضا حساب قيم مقاومة التوالي لكل بطارية علي حدة. ومن فحص وتحليل منحنيات مقاومة التوالي في الحالات السابقة تبين انه بالرغم من أن البطاريتان كانتا متماثلتان تماما الا انه في حالة توصيلهم علي التوازي فإن أحدهم تكون دائما حل علي الأخرى مما يؤدي الي وجود تيار في الدائرة الكهربية بين البطاريتين مما يعوق عملية الشحن. ومن هنا فانه يوصي بشحن البطاريتان معا وهما موصلتان علي التوالي بالرغم من أن مقاومة التوالي الكلية لهم تكون أكبر من تلك التي يتم الحصول عليها في حالة توصيلهم علي التوازي.

ABSTRACT

This paper illustrates the series resistances of two parallel and series connected batteries. The series resistances are calculated based upon experimental measurements at solar energy laboratory. The batteries under test are supplied by solar cells array for few days for charging them. The experiments show that, the best configuration is series one in spite of it's large series resistance than parallel configuration.

INTRODUCTION

Photovoltaic (PV) generators are, probably, the cleanest method of electrical power generation. They produce no noise, no harmful polluting emissions and need no fuel other than sunlight. The applications in which photovoltaic systems are used increasing as the cost of photovoltaic modules decreases[1].

A stand-alone photovoltaic power system consists of photovoltaic arrays, power conditioner and an energy storage. The energy storage is very important in stand alone photovoltaic system. It is used to store solar energy and as a maximum power tracking element[2]. A brief background on the preparation of standard energy storage equipment is existed in for standard document prepared for large storage batteries. These documents are used to prepare batteries at power stations, substations and photovoltaic power systems (PVPS)[2,3].

The lead acid battery storage configurations have a pronounced effect on ampere-hour capacity. Three configurations; a conventional, a parallel and a dual, were analyzed for both shallow cycle and deep cycle lead acid batteries to determine if capacity improvement is achievable. A dual battery configuration when used with deep cycle

batteries has a positive effect on the available capacity. Incorporation of a dual configuration achieves optimum utilization of photovoltaic array [4,5,6].

In this paper new techniques are used for obtaining the lead acid battery series resistance. Two batteries are connected in two configurations, then series resistance of each of which is deduced. A comparison between series resistance of the two configurations is illustrated. Then the best configuration is defined.

RESULTS

The effect of series and parallel configuration of lead acid batteries upon series resistance is carried out based upon experimental data. These data are obtained by connecting two identical lead acid batteries each of which is 6V, 6Ah firstly in parallel configuration then, in series configuration. For each configuration, the batteries are supplied by a solar cells array (SCA).

a- Parallel Configuration :

Two identical batteries are connected in parallel and supplied from a solar cells array as shown in fig.1. During charging process, the charging circuit is opened at selected times (noon and 4 pm during charging days) for few minutes. For each instant the batteries are connected through recorder which the terminal voltage is recorded against time as shown in fig.2a. This process is repeated for 9 days, over their the batteries are charged and reach to over charge condition. Figs.2a,2b. give the data required for obtaining series resistance of parallel configuration at the selected instants. These figures represent the terminal voltage of parallel configuration batteries during open circuit condition during the selected instants of charging period. At these instants the terminal voltage of each open battery (B_1 and B_2) is recorded also by the recorder as shown in figures 2c, 2d for battery number one and figures 2e, 2f for battery number two. The series resistance can be obtained from the following equation :-

$$R_{sp} = \frac{(V_{ibef} - V_{iaf})}{I_{ibef}} \quad (1)$$

where :- R_{sp} is the equivalent series resistance of the two parallel batteries;
 V_{ibef} is the terminal voltage of the parallel configuration batteries directly before open circuit condition;
 V_{iaf} is the terminal voltage directly after open circuit condition; and
 I_{ibef} is the current supplied to the two batteries before open circuit condition from SCA.

Figs.3 and fig.4 illustrate series resistance of the previous batteries configuration during the selected times for few periods of charging condition. The two figures are a similar, this is because at the first instant (noon), the charging current is more than the B_2 .

The batteries are reconnected again to charging circuit directly after obtaining figures 2a and 2b for few minutes. Then, the charging circuit is open again and one battery of them is terminated to a recorder and figs.2c,2d are obtained at the previous instants. The same procedure is repeated for obtaining figures 2e and 2f for the second battery.

Equation (2) is used for determining the series resistance for each battery, which is written as follows :-

$$R_{si} = \frac{(V_{tbe}f - V_{tate}f)}{I_{tbe}f} \quad (2)$$

where : R_{si} is the equivalent series resistance of one battery;

$V_{tbe}f$ is the terminal voltage of one battery directly before open circuit condition

$V_{tate}f$ is the terminal voltage of one battery directly after open circuit condition and

$I_{tbe}f$ is the current energized one battery before open circuit condition from SCA

Figures 6 and 8 illustrate the series resistance calculated from the experimental results obtained at another instant, 4pm. These figures ensure that B_2 is one is loaded on battery two (battery one discharges through battery two). For instance during time period 59hrs < t > 72hrs of charging time. The behavior of series resistance are opposite. During this period the series resistance of B_1 increases where it decrease for B_2 .

b- Series Configuration :

The two batteries are reconnected in series configuration and their series resistance is determined by the same procedure used above. Figs.5 and 7 represent the behavior of series resistance of B_1 and B_2 , respectively. These figures illustrate that their behaviors take an opposite direction. The increasing rate of series resistance of B_1 within period $t > 60$ hrs is faster than the increasing rate of series resistance of B_2 within the same period. This means that the B_1 discharges through B_2 during this period. The experiment shows that the charging process for more than one battery must be done by connecting them in series, even when they are identical batteries. So the second experiment is carried out by connecting the two batteries in series. During charging process, the charging circuit is opened at selected times (noon and 4pm during charging days). For few minutes of each instant the batteries are connected through a recorder which gives the terminal voltage as shown in figs.(9.a) and (9.b) for selected times. This process is repeated for 9 days. The batteries are charged and reached to over charge condition. The series resistance can be obtained from the following equation :-

$$R_{st} = \frac{(V_{tbe}f - V_{tate}f)}{I_{tbe}f}$$

where :- R_{st} is the equivalent series resistance of two batteries;

$V_{tbe}f$ is the terminal voltage of a series configuration batteries directly before open circuit condition;

$V_{tate}f$ is the terminal voltage of a series configuration batteries directly after open circuit condition;and

$I_{tbe}f$ is the current supplied the two batteries before open circuit condition from SCA.

Figure 10 represents the equivalent series resistance of the two batteries at a selected instance (noon instant). This figure illustrates that, at the beginning of charging periods the value of series resistance increases fastly till charging time becomes 23 hours. After this time the rate of increasing of the resistance is decreased. On the other hand, figure 11 represents the series resistance of the series batteries takes a stable values. This is due to large accumulation of charges within batteries (end of charging period).

CONCLUSIONS

In this paper the behavior of the series resistance of the two lead acid batteries connected in series and parallel is investigated during charging process. The experiments show that, the charging of series batteries is recommended in spite of it has a large value of series resistance. On the other hand during charging of parallel connected batteries a circulating current between them is initiated even for two similar batteries. This current leads to prevent charging of the two batteries in spite of it has a small value of series resistance.

REFERENCES

- 1- A.M. Abdel-Halim, H.G. Hamed and M.A. Al-Ahmar, "Effect of Cell Temperature on the Performance of A Photovoltaic Generator/DC Motor System", Sixth Middle East Power System Conference (MEPCON'98).
- 2- I.H. Bellock, "Update on Standards for Large Lead Storage Batteries for Generation Stations and Substations", IEEE Transaction on Power Apparatus and Systems, Vol.1, Pas-99, No.5, Sep./Oct. 1980.
- 3- Twos Markvart, "Solar Electricity", Book, RePrinted in July, 1996, Jonwilky and sons.
- 4- Ziyad M. Salameh, "Lead-Acid Battery Storage Configuration for improved Available Capacity", IEEE Transactions on Energy Conversion, Vol.11, No.1, March 1996.
- 5- Ziyad M. Salameh, "Determination of Lead-Acid Battery Capacity via Mathematical Modeling Techniques", IEEE Transactions on Energy Conversion, Vol.7, No.3, September 1992.
- 6- Technical-Marketing Staff of Gates Energy Products, Inc. "Rechargeable Batteries Applications Handbook" Book, Copyright 1992, by Butterworth- Heinemann.

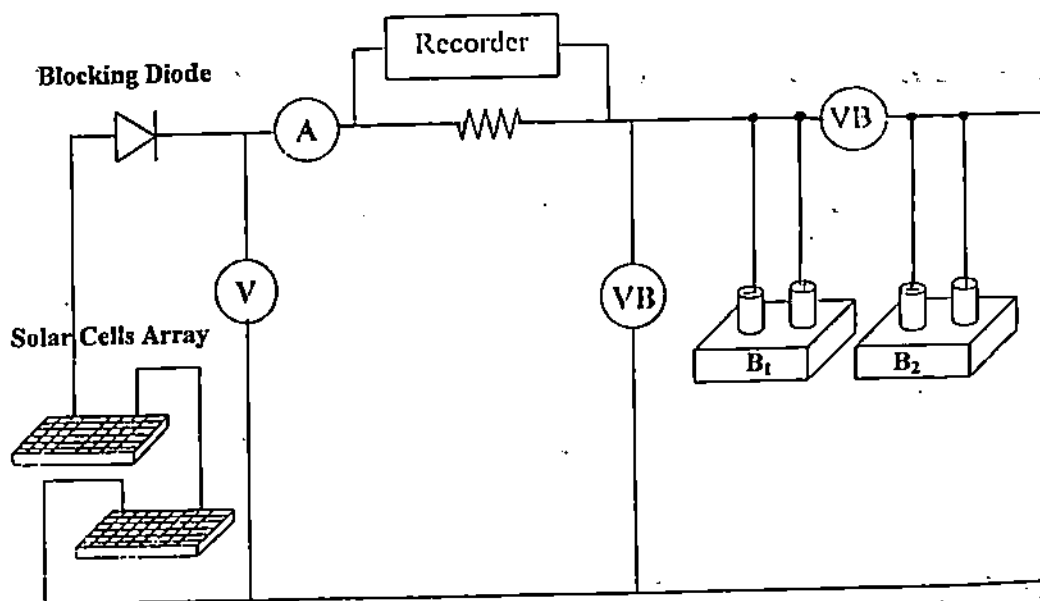

Fig.1 The connection diagram of parallel configuration batteries under test.

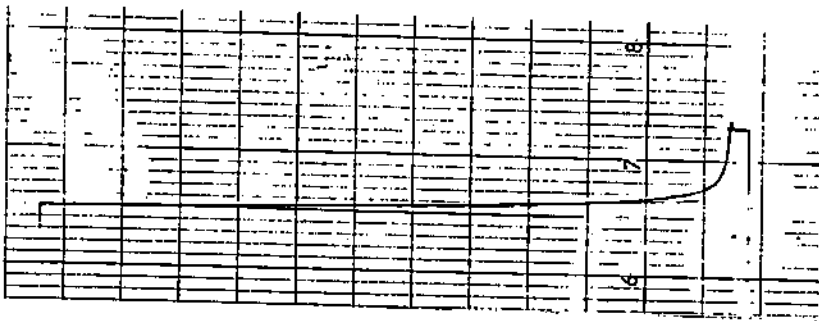

Fig. 2a

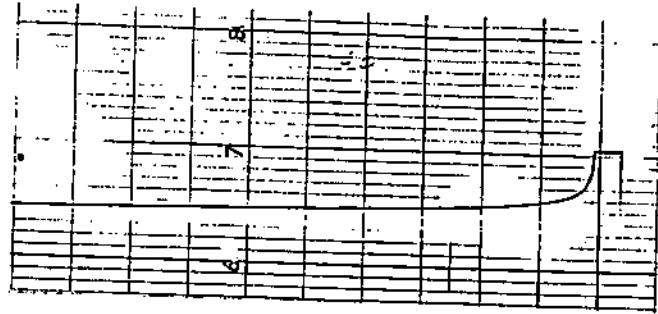

Fig. 2b

Fig.2 Terminal voltage of parallel connected batteries as recorded during open circuit condition after 62.72hrs and 66.8hrs, respectively of charging times.

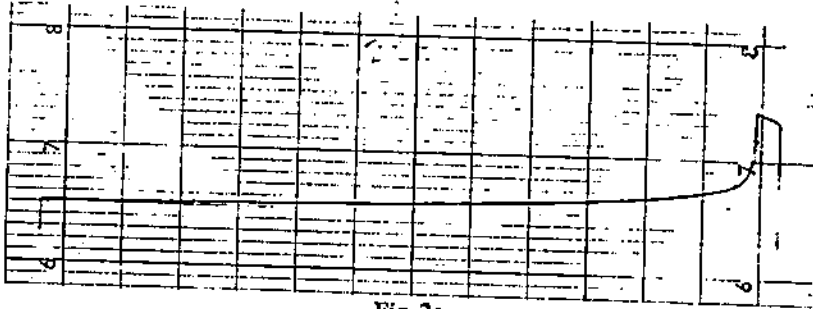

Fig. 2c

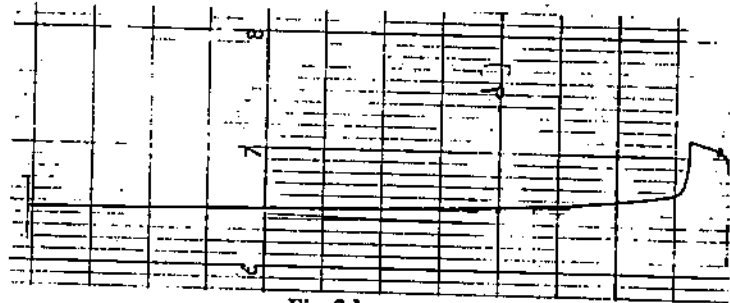

Fig. 2d

Fig.2 Terminal voltage of B_1 only recorded during open circuit condition after 62.72hrs and 66.8hrs, respectively of charging times.

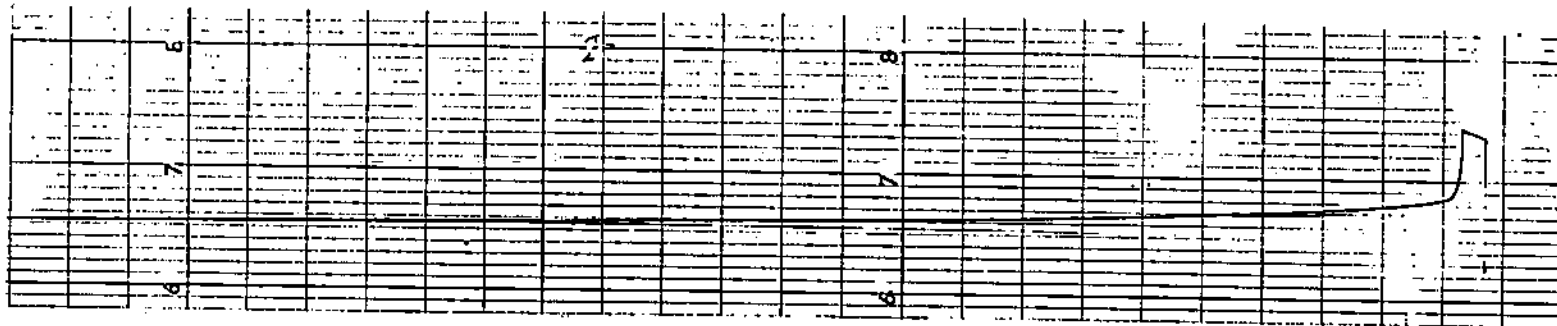

Fig. 2e

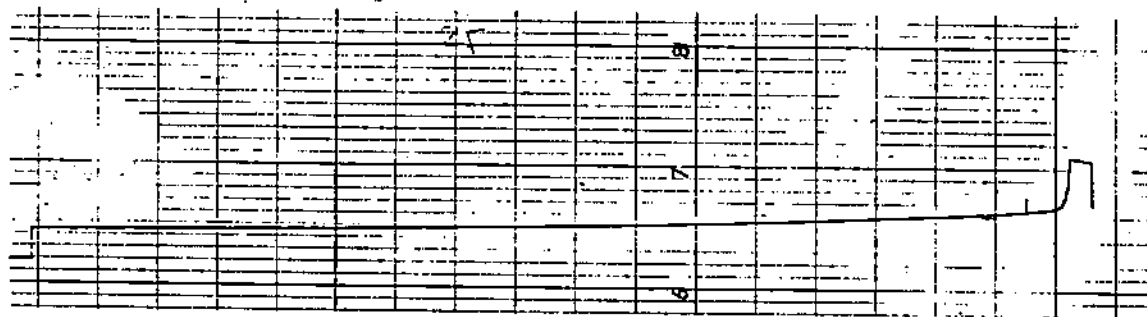

Fig. 2f

Fig.2 Terminal voltage of B₂ recorded by recorder during open circuit condition after 62.72hrs and 66.8hrs, respectively of charging times.

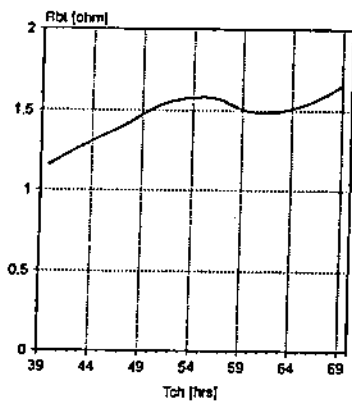

Fig.3 Series Resistance Against Charging Time at Noon Instants for Two Parallel Batteries.

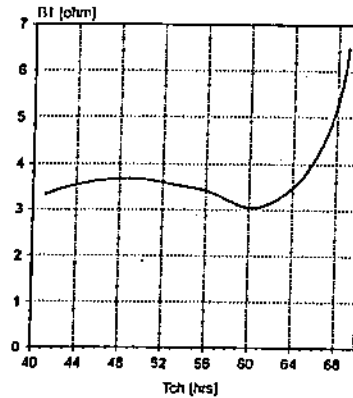

Fig.5 Series Resistance Against Charging Time at Noon Instants for B_1 .

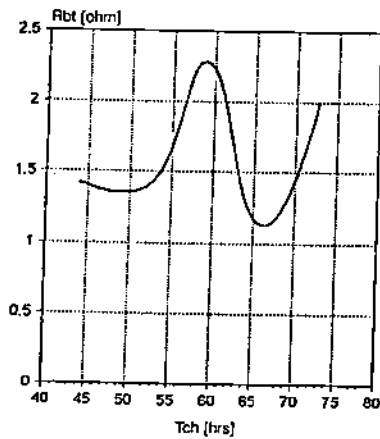

Fig.4 Series Resistance Against Charging Time at 4 PM Instants for Two Parallel connected Batteries.

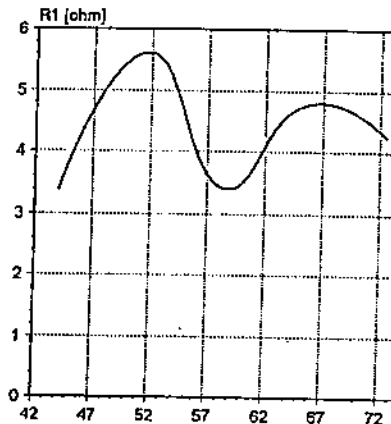

Fig.6 Series Resistance Against Charging Time at 4 PM Instants for B_1 .

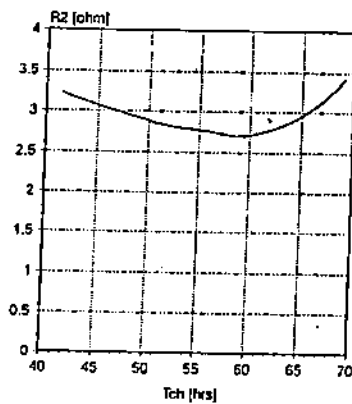

Fig.7 Series Resistance Against Charging Time at Noon Instants for B_2 .

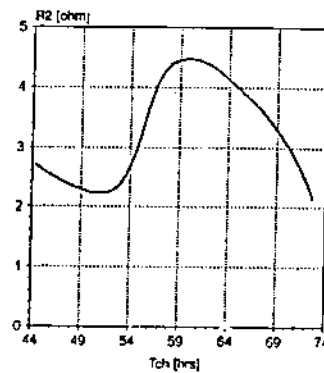

Fig. 8 Series Resistance Against Charging Time at 4 PM for B_2 .

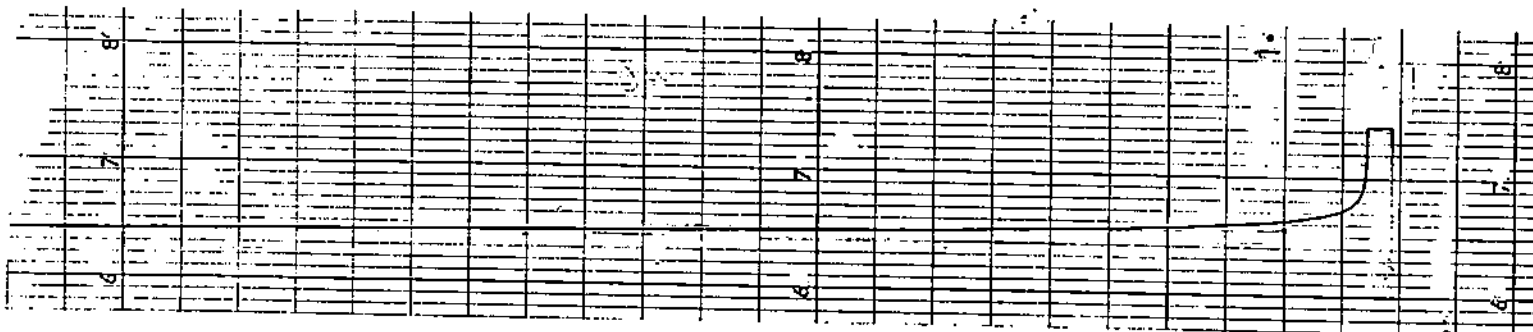

Fig. 9a

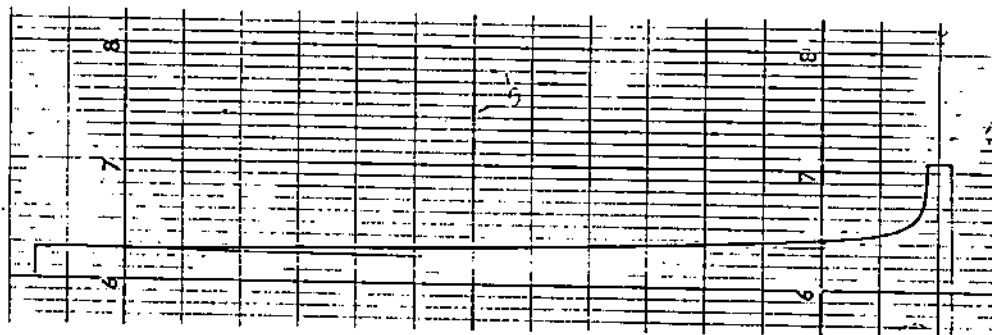

Fig. 9b

Fig. 9 Terminal voltage of series connected batteries during open circuit condition recorded after 44hrs and 47.33hrs, respectively of charging times.

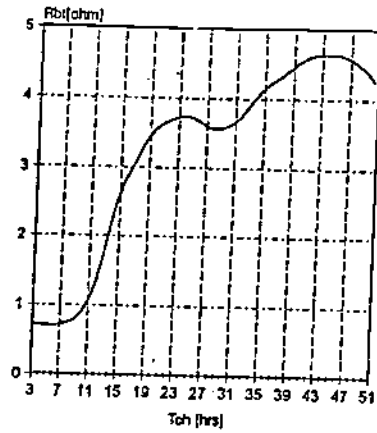

Fig. 10 Series Resistance Against Charging Time at Noon Instants for Two Series connected Batteries.

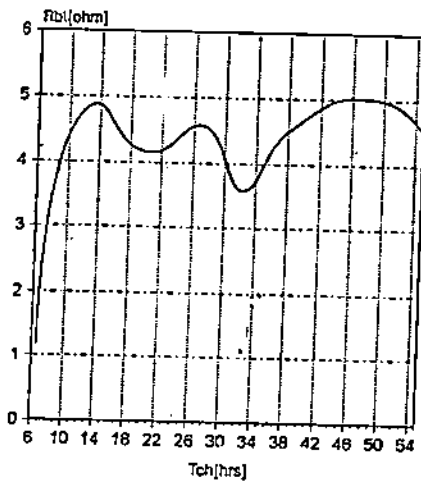

Fig. 11 Series Resistance Against Charging Time At 4 PM for Two Batteries.