

INFLUENCE OF CONTAMINATED DROPS ON POLYMERIC INSULATION SURFACES IN THE VICINITY OF HIGH VOLTAGE TRACKING

S. S. El-Dessouky
Electrical Engineering Department
Faculty of Engineering
Suez Canal University
Port-Said, Egypt

تأثير الجزيئات الملوثه على أسطح عازلات البولمر التقريبه من تأثير مساريه الجهد العالي

الخلاصة :-

مقاومة العوازل الكهربائيه الموجوده في الخلاء للاجهادات الكهربائيه تتطلب بالضروره ضمن الدراسه العامه لمستويات سلوك العزل . بحث مقاومة العزل للمعرض للتأثيرات المساريه عليه التي تسببها الجهود العاليه . من هذا المنطلق فإن تأثير التلوث المتواجد في صورة جزيئات (نقاط أو رزاز ملوثة) والتقريبه من التأثير المساري للجهد العالي على أسطح العازلات البولمرية قد تم تناولها في هذا البحث . وجدير بالذكر أن المواد العازلة البولمرية التي أجريت عليها لتجارب كانت انبكاليت ، البلاستيك والبوليسترين . هذا وقد تم دراسه سلوك تيارات الزحف التي تعرضت لها أسطح عازلات البولمر تحت تأثير معدلات مختلفه لمقادير الجهد العالي للتيار المتغير طبقاً للاسس العالمى رقم ٥٨٧ . وقد إتضح أن تيارات الزحف المساريه على أسطح عازلات البولمر تحت تأثير الجهود العاليه (في حدود من ١ الى ٦ كلف) تعتمد على عدة عوامل منها مقدار الجهد المسلط ومقدار تغير التلوث وحجمه . أضف الى ذلك أنه قد تم بحث عمليه التجويف التي تنشأ نتيجة للتفاعل الكيماوى بين جزيئات التلوث و سطح العازل أثناء تعرضه لتيارات الزحف المساريه . كما تم اقتراح أن نسبة تيارات الزحف المساريه للقيمه للعظمى الى للقيمه للمتوسطه يمكن أن تستخدم كمؤشر واد لمعرفه مدى انتاكل (التجويف) على أسطح عازلات البولمر .

ABSTRACT

The resistivity of electric outdoor insulations against electric stresses is determined decidingly among other characteristics forming the insulation coordination systems by its insulation against high voltage tracking. From this point of view, the effect of contamination on polymeric insulation surfaces in the vicinity of high voltage tracking is presented. The polymeric

insulating materials treated in this work are Bakelite (Ba), Polyvinylchloride (PVC) and Polystyrene (PS). Behaviour of creepage current under some typical ratings of high voltage a.c. according to the IEC standard 587 is introduced. The insulation against h.v. tracking is dependent on the amplitude of the applied voltage stress, changes in the degree of contamination and on its size on the insulation surface. Erosion process due to the chemical reactions between pollution and insulation surface during the creepage stress has been investigated. Results suggest that the peak to average current ratio during creepage stress up to the end point of h.v. tracking may be used to determine the value of erosion depth of polymeric materials.

INTRODUCTION

The increasing use of solid organic insulating materials in h.v. equipment has occasioned growing interest in the study and assessment of the effect of creepage stresses on the insulation surface. Polymeric insulators subjected to high voltages suffer from the degradation by tracking [1-4]. It is believed that tracking arises as a result of pure thermal decomposition and polymer damage by electron bombardment. A high electric stress can be created at the interface between conductor and polymeric insulator due to the presence of non-uniform fields. This stress leads to local discharges with corona effects, even when the voltage difference between electrodes is not enough to cause complete flashover [5,6]. However, interruption of moisture films is caused by drying the surface following the heating effect of leakage current. Sparks are drawn between the separation moisture films, which acts as extensions to the electrodes and damage is done [1].

Most of work done in this field has concerned generally with organic materials. Recently, the polymeric insulation materials are widely used. Therefore, it is important to determine and implement further experiments required to define the behaviour of these polymeric materials. So, this paper presents the evaluation of polymeric insulating materials for use under outdoor high voltage application by measuring the creepage characteristic as well as the resistance to tracking using a liquid contaminant and insulator plane specimens as recommended in IEC standard, published 587 [7]. The present series of measurements are carried out on the same polymeric materials as used in our previous work [8-10]. In case of Bakelite insulator, it is found that at a voltage tracking up to 600 volt the creepage current has a value less than that of other polymeric materials and carbonization takes place rapidly before forming erosion.

As part of this work, the experiments have been developed to measure the creepage current of polymeric insulating materials during the high voltage stress up to 6 kV to the end point of h.v. tracking. The erosion rate due to the heating effect and the chemical reactions between contamination and insulation

surface have been investigated as a function of the insulation weight loss. However, the erosion depth has been measured and evaluated as a function of average to peak current ratio.

EXPERIMENTAL METHOD

Tests have been carried out using the arrangement illustrated in Fig. 1. The voltages up to 6 kV, 50 Hz have been applied between electrodes by using 80 kV, 25 kVA high voltage transformer in conjunction with an induction regulator as a smooth control unit and a measuring voltmeter on the primary side (0 - 220 volt) as well as a measuring sphere-gap type MKTW-5R on the h.v. side (0-80 kV output).

Two stainless steel electrodes contacted the polymeric insulator are placed 50 mm apart as those used in the IEC standard, publication 587. The specimen is set up with its longer axis at 45° to the vertical and the electrodes are attached to the underside, as shown in Fig. 2.

The insulants treated in this work are bakelite (Ba), polyvinylchloride (PVC), polystyrene(PS). The samples measure 50 mm x 120 mm with 4 mm in thickness.

The application of liquid contaminant can be done by dripping the solution in order of 0.1% ammonium chloride in distilled water into the filter paper pad with a fixed flow rate. A 200 watt resistor is connected in series with each specimen on the high voltage side. These processes are made according to the IEC standard 587 [7] as given in Table I.

Table I Test voltage, contaminant flow rate and series resistor.

Test voltage (kV)	Contaminant flow rate (ml/min)	Series resistor (k Ω)
1	0.075	1
2	0.15	10
3	0.30	22
4	0.60	33
5-6	0.90	33

tests, the method is chosen as a contact tracking voltage the creepage stress and the distance between electrodes is fixed to 50 mm. Through this IEC standard distance, a partial conducting path is created by localized deterioration on the polymeric insulating surface. The track starts at the lower electrode and the end point is reached when the track reaches a mark on the specimen surface at 25 mm from the lower electrode as shown in Fig. 2. As in our previous paper of low voltage tracking [10], a data acquisition processing is also used in the present work under h.v. tracking to register the creepage current values flowing into the circuit.

Fig. 3, shows the graph of the creepage current behaviour obtained by using a data acquisition processing. To confirm the accuracy of these results, a portable pen-recorder instrument (type 30570) is used. The creepage current is, also, directly recorded on the chart as demonstrated in Fig. 4. It is seen from the two figures 3,4 that, a consistent result of creepage current behaviour for both two procedures. However, a data acquisition processing is used in most experiments.

RESULTS OF EXPERIMENTS

The experiments start with a creepage distance of 50 mm between the h.v. electrodes. According to the IEC standard, publication 587 [7], the contaminant conductivity on the insulation surface is 2.5 ms/cm (or 395 ohm-cm resistivity). The voltage is maintained constant during 6 hours. It is found that, for the polymeric insulating materials under test, no h.v. tracking occurs at most different ranges of IEC 587 up to 6 kV, as shown in Table II.

Table II Creepage stress during 6 hours.

Material	Ba	PS	PVC
conductivity(ms/cm)	2.5	2.5	2.5
Voltage(kV)	2-6 kV	2-6 kV	2-6 kV
Aver. current	3-4.3	2.6-2.8	2.9-2.98
Tracking condition	no tracking occurs.		

Choosing another value of contaminant conductivity higher than that of 2.5 ms/cm, the tracking test can be accelerated in the laboratory within the information of IEC standard 587. Fig. 5, shows the creepage current behaviour for PVC at contaminant conductivity of 7.5 ms/cm and applied h.v. a. c. of 6 kV. It is seen from the figure that, the PVC insulator can withstand the creepage stress during 6 hours and then tracked directly. The other insulators of Ba and PS are tracked at a time less than 6 hours at the same condition of contaminant (7.5 ms/cm) as shown in Figs. (3 or 4),6. Thereby, the PVC is found to possess the best h.v. tracking behaviour than that of Ba and PS. This insures that, the polymeric insulating material of Ba has the worst h tracking and the PS is the second worst one. This result is consistent with our previous work in [8,9] carried out at voltage up to 600 volt. In a word, regardless of voltage value (low or high), the worst behaviour of insulating materials can be determined, i.e., the worst level of insulation creepage/tracking behaviour (CTB) is independent of the applied voltage value.

Fig. 7, shows the relation between the erosion depth and the creepage distance up to the end point of tracking at 25 mm from the lower electrode. Fig. 8 shows the photographs of h.v. tracking for both polymeric insulating materials Ba, PS and PVC. It is clear from the two figures that, the erosion depth decreases with increasing the distance from the lower electrode. Fig. 9, illustrates the erosion depth versus the applied h.v. a.c. for both

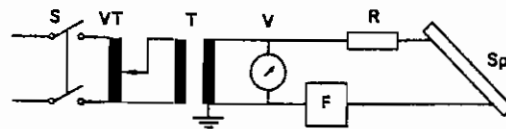

- S = power supply switch
- VT = variable ratio transformer
- T = high-voltage transformer
- R = series resistor
- V = voltmeter
- Sp = specimen
- F = overcurrent device, fuse or relay

Fig. 1. Test circuit.

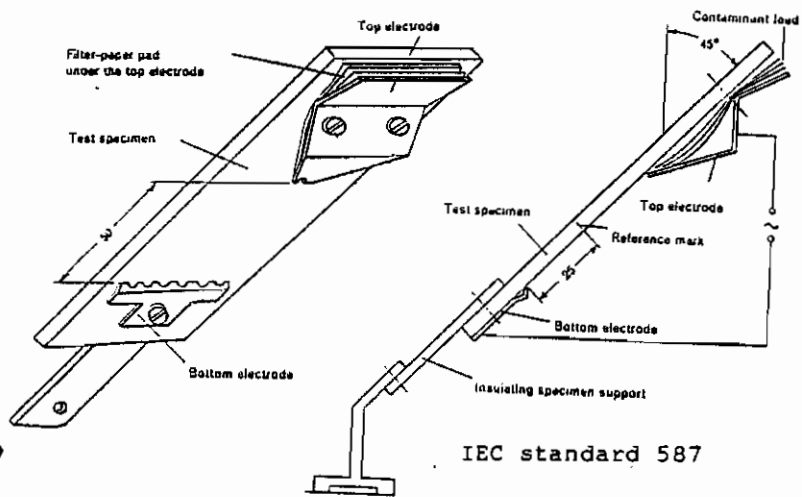

Fig. 2. Assembly of the electrodes.

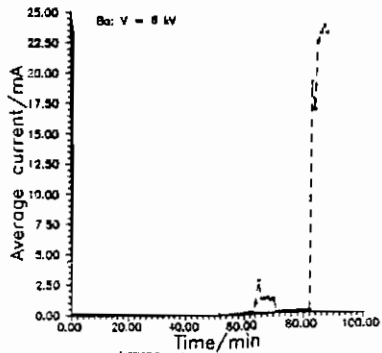

Fig. 3. Creepage current behaviour for Ba at 6 kV and 7.5 ms/cm by using a data-acquisition processing.

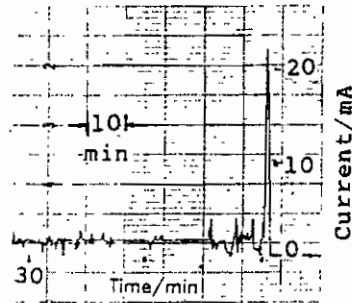

Fig. 4. Creepage current behaviour for Ba at 6 kV and contaminant conductivity at 7.5 ms/cm by using Pen-recorder.

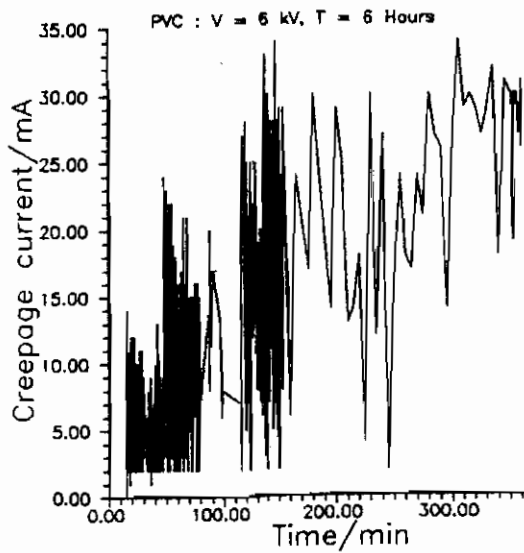

Fig. 5. Creepage current behaviour for PVC at 6 kV and 7.5 ms/cm.

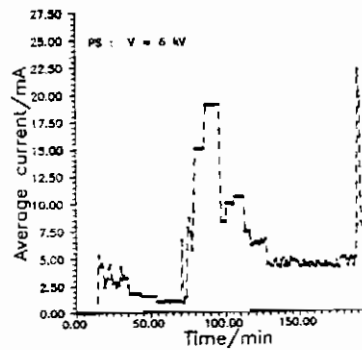

Fig. 6. Creepage current behaviour for PS at 6 kV and 7.5 ms/cm.

insulating materials of Ba, PS and PVC. It can be seen that, the erosion depth increases with decreasing the applied voltage. Although the tracking time in case of PVC is greater than that of Ba and PS, the insulation surface of Ba and PS can not withstand the creepage stress for a long time period and the degradation by tracking is going rapidly. This phenomenon may be due to the stronger effect of sparks which causes an increase of the carbonization traces between the separation moisture film on the insulation surface for both Ba and PS. Additional information is provided by the actual measurements of erosion as the insulation weight loss. Fig. 10. shows the relation between the insulation weight loss and the creepage time up to the end point of tracking. It is seen from the figure that, the insulation weight loss increases with increasing the creepage time. The slop of the curve can be regarded as an erosion rate (mg/h), i.e. the degradation on the surface due to the carbonization tracks can be obtained as a function of the insulation weight loss.

Fig. 11, illustrates the behaviour of average creepage current as the voltage is raised for different values of electrolyte conductivity. At values of low voltages, in the range (0-2 kV), the current is proportional to both voltage and electrolyte conductivity, so the contaminant film acts as an aqueous resistor. After that, a dry band formation occurs at certain point in direction of high voltages and therefore the creepage current flow is no longer continuance over the entire a.c. cycle. In addition, discharging can occur in intermittent bursts. Similar behaviour have been found elsewhere [11] for another insulating materials. Fig. 12, shows both average and tracking current as a function of applied voltage a.c. It is seen from the figure that, the average and tracking currents increase with increasing the applied voltage and they have greater values when using the Ba insulator than that of PS and PVC insulators at high values of applied voltages, vice versa they have lower values for Ba insulator at low voltages. This means that, the heating effect due to the higher values of creepage current at high voltages causes an increase in the evaporation process of contaminant moisture film on the insulation surface more than that at low voltages and this depends on the type of the polymeric material.

shows the peak to average current ratio as a function of h.v. a.c. It is seen from the figure that an increase of voltage increases the peak to the average current ratio. This means that the increase of the discharge current magnitude causes an increase in the heat energy. This leads to decrease the erosion depth due to the evaporating effect. This result may be used to point out the value of erosion as a function of the peak to average current ratio when subjecting the insulating materials to the creepage stress.

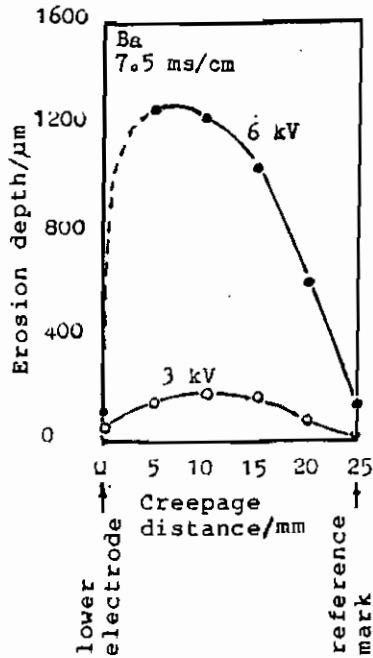

Fig. 7. Erosion depth versus creepage distance from the lower electrode

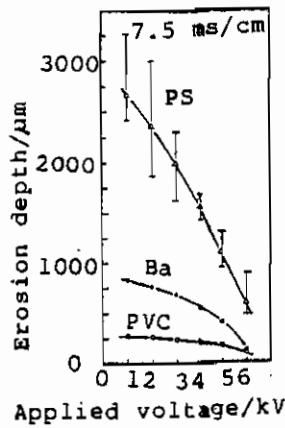

Fig. 9. Erosion depth versus applied h.v. a.c.

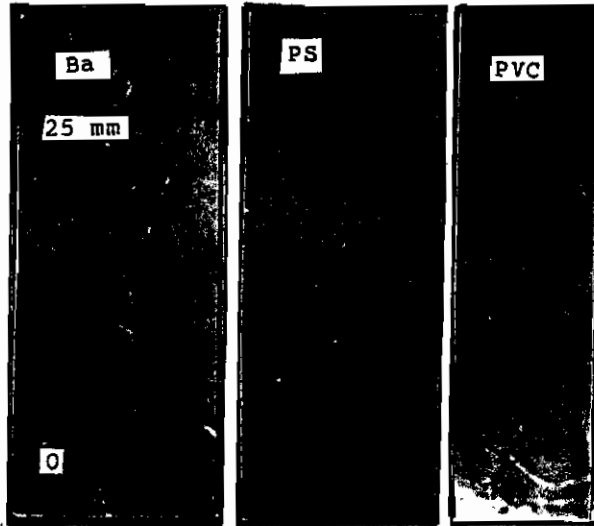

Fig. 8. Photographs of h.v. tracking for Ba, PS and PVC at electrolyte conductivity of 7.5 ms/cm and 3 kV appl. voltage.

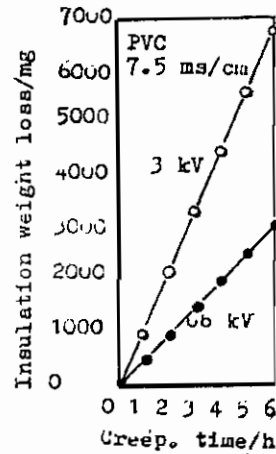

Fig. 10. Insulation weight loss versus creepage time to the end point h.v. tracking.

Fig. 11. Average creepage current to electrolyte conductivity as a function of appl. voltage

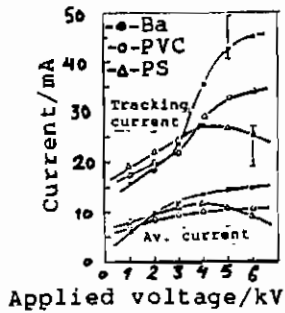
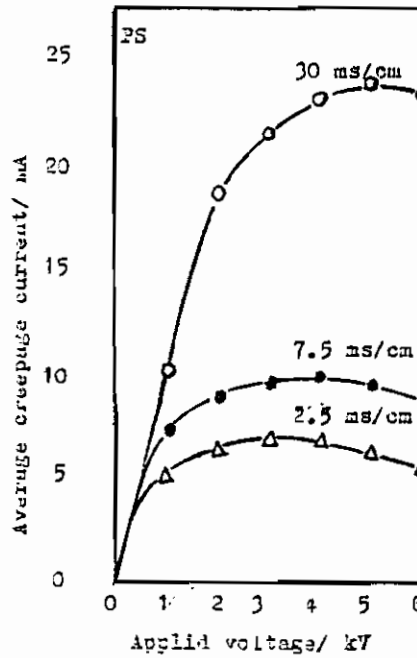

Fig. 12. Tracking current and average creepage current versus applied h.v. a.c.

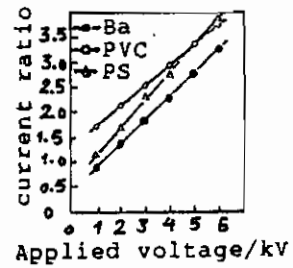

Fig. 13. Peak to average creepage current ratio versus applied h.v. a.c.

CONCLUSIONS

The following conclusions have been drawn from investigating the effect of creepage stress on the h.v. tracking of polymeric materials :-

- The characteristic of Ba has the worst h.v. tracking, i.e., the same as that for low voltage tracking. The PS is followed to Ba as a second worst one. Therefore, regardless of voltage value (low or high), the worst behaviour of insulating materials can be determined, i.e., the worst level of behaviour is independent of the applied voltage value.
- The degradation on the polymeric surface due to the carbonization tracks can be obtained as a function of the insulation weight loss.
- The result of peak to average current ratio obtained during creepage stress up to the end point of h.v. tracking may be used to point out the value of erosion depth of polymeric materials.

REFERENCES

- [1] Alston, L. L., "High voltage technology", Book, Oxford University Press, pp. 158-169, 1968.
- [2] Billings, M. J., et al., "Tracking in polymeric insulation", IEEE Trans. Elect. Insul. Vol. 2, pp. 131-137, 1967.
- [3] Tanaka, T., et al., "A basic study on out door insulators of organic materials", IEEE Trans. Elect. Insul. Vol. 13, pp. 184-193, 1978.
- [4] Mason, J. M., "Discharges", IEEE Trans. Elect. Insul. Vol. 13, pp. 211-238, 1978.
- [5] Barsch, R., Pilling, J., "Zur elektrischen Alterung und Überschlag an Kunststoffisolator-Oberflächen elektrolytschleitfähigen Fremdschichten" Wiss. Bericht 903, PP.36-41, 1988.
- [6] Nunes, S. P., et al., "Tracking degradation and pyrolysis of EPDM insulators", IEEE Trans. Elect. Insul. Vol. 13, pp. 99-105, 1989.
- [7] IEC standard, publication 578, 1977-1984.
- [8] El-Dessouky, S. S. and Youssef, F.M.H., "Factors affecting creepage and clearance distances of polymer insulators...", 6th Inter. Symp. on Electrets (ISE 6), The Queen college, Oxford, England, pp.354-358, 1988.

- [9] El-Dessouky, S. S. and Youssef, F.M.H., "About the creepage characteristics of some current polymer insulating materials", Conf., MEPCON 89, Egypt, paper no. EE04-021, Vol. 1, pp. 111-115, 1989.
- [10] El-Dessouky, S. S., "Effect of creepage stress on the insulation tracking of polymeric materials", 25th Universities Power Engineering Conference (UPEC'90),
- [11] Jolly, D.C., "A quantitative method for determining the resistance of polymers to surface discharges", IEEE Trans. Elect. Insul. Vol. 17, pp. 293-299, 1982.