

POWER FACTOR CORRECTION OF A PERMANENT-MAGNET SYNCHRONOUS MACHINE-DRIVE

USING A TRANSISTORIZED INVERTER WITH BYPASS WAYS

تصحيح معامل القدرة لنظام تحريك ذو آلة متزامنة بمفردات دائمة باستخدام معبر ترانزستوري ومسارات نحوي

Salah Gh. Ramadan

Zagazig University - Faculty of Engineering (Shoubra)

ملخص البحث:

هذا البحث يشتمل على تصميم و تنفيذ دائرة مغير ترانسستوري معدلة لتحسين معامل قدرة الآلة المتزامنة الدائمة المغناطيسية وذلك عن طريق منع جزء موجة التيار المختلف في التطبيقية مع فرق الجهد المناظر له من المرور بعلقات الآلة المتزامنة و بذلك يتقدم المحور الجديد لموجة التيار المعدلة. وكذلك تم تنفيذ دائرة تحكم جديدة لتحديد خواص الآلة المتزامنة حيث يتم التحكم في عزم الدوران و محملة الفيض المغناطيسي بالثغرة الهوائية وذلك عن طريق ضبط مقدار واتجاه التيار البار بعلقات الآلة و زاوية تشغيل دائرة المغير. ومن نتائج هذا البحث أحداث تحسن ملحوظ في معامل القدرة بالمقارنة بدائرة المغير المعتادة. ويجب ملاحظة أن فكرة دائرة المغير المستخدمة وكذلك دائرة التحكم يمكن استخدامها مع نظام ذو قدرة عالية بإبدال المغير الترانسستوري بأخر ثايرستوري.

ABSTRACT

This paper describes a synchronous machine drive system in which the advantage of a method for power factor correction is taken and practiced. In this method the phase currents are forced, at definite instantaneous values, to bypass the three phases of the machine. Also a new control circuit for the system is theoretically clarified and then practically performed. Here the airgap flux and the induced torque are controlled in accordance to the speed. Thereafter the amplitude of the stator current and its phase angle are controlled to satisfy the load torque and the magnetizing conditions. The machine available is a small permanent-magnet synchronous machine and therefore a constant-current small-power rectifier-inverter set with a transistorized inverter is used to avoid the complicity of the firing commutating circuits. Using such a type of inverters and applying this method of power factor correction, the permanent-magnet machine can run with a nearly unity power factor. The obtained results of the steady-state as well as the transient responses are given.

1. INTRODUCTION

The ability to control the power factor of the synchronous machine-drive by simply varying the firing-angle of the inverter coupled with the machine is of very great practical importance. The importance lies in the fact that a synchronous motor can operate at a leading power factor, when possible, and consequently the overall power factor for the installation can be improved.

By conventional synchronous machine-drive systems described in [1] and [2] naturally commutated converters were used, the machine was overexcited and hence the power-factor was leading but still less than unity. Using forced commutated converters, a unity power factor can be reached. In the two systems, the field current, load current, and the turn-off time of the used thyristors were mentioned in calculating the inverter firing-angle corresponding to the optimal power factor. In the system presented, the power factor is always inductive.

In this paper the method of the power factor correction which was studied for high power induction machine drive systems, [3]-[4], is modified to drive a practical permanent-magnet synchronous machine drive system. The performed system contains a new transistorized inverter configuration. Figure 1.a shows such a connection. Two bypass transistors (called zero transistors), QA and QB, are connected between the mid-point of the stator winding and the output leads of the coupled inverter.

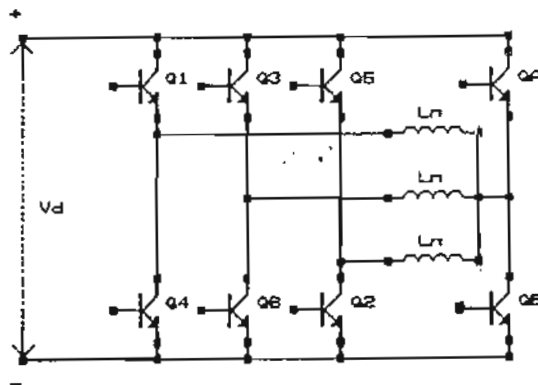

Fig.1.a.

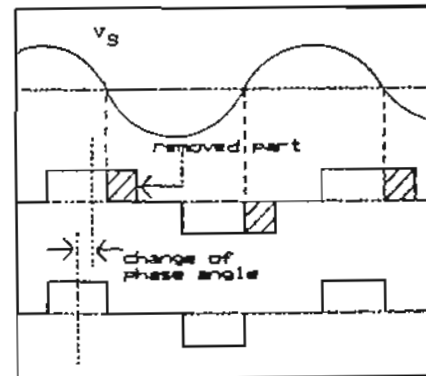

Fig.1.b.

Fig.1. Principle of power factor correction

The principle of this method is as follows:

Since in the three-phase systems, as here, the widths of the positive or the negative parts of the phase current-blocks are 120° , therefore the axis at which the maximum values of the fundamental harmonics of the phase currents coincide are always at half of the current-blocks as seen in Fig.1.b. In the method used the instantaneous values of the phase current-blocks which are negative with respect to the corresponding phase voltage are forced to skip the phase winding through a responsible transistor. Therefore the actual phase current-block is terminated before reaching the normal 120° -width. Due to this change the axis of the maximum value of the fundamental harmonics is shifted to the left at the new half of the current-block as shown in Fig.1.c, therefore the effective phase angle becomes smaller. Due to the abridgment of the phase current, its effective value is reduced. This disadvantage is corrected through the control system to change the amplitude of the dc link current.

2. DESCRIPTION OF THE DRIVE-SYSTEM

2.1. The Power Circuit

The block-diagram of the studied system is indicated in Fig.2. Here, the inverter consists of a three-phase transistorized bridge ($Q_1 - Q_6$). Each transistor is protected by an antiparallel diode ($D_1 - D_6$) [5],[6]. In order to improve the power factor, more than that given due to the calculated inverter firing angle, two additional bypass transistors (Q_A and Q_B) protected by two diodes (D_A and D_B) are connected between the mid-point of the three-phases of the machine and the output leads of the inverter. Other improvement is accounted if the overlap-angle and the transistor turn-off time are considered in calculating the inverter firing angle of the inverter.

The power-source consists of a three-phase transformer coupled with a half-controlled three-phase rectifier (naturally commutated) and a dc link consisting a constant current source. By this type of rectifiers the power-factor of the overall system is better than if a fully controlled rectifier is used. The same principle of the power-factor correction used by the inverter can be followed to optimize the power factor of the overall system by addition of other two bypass thyristors between the mid point of the used supply transformer and the output edges of the rectifier:

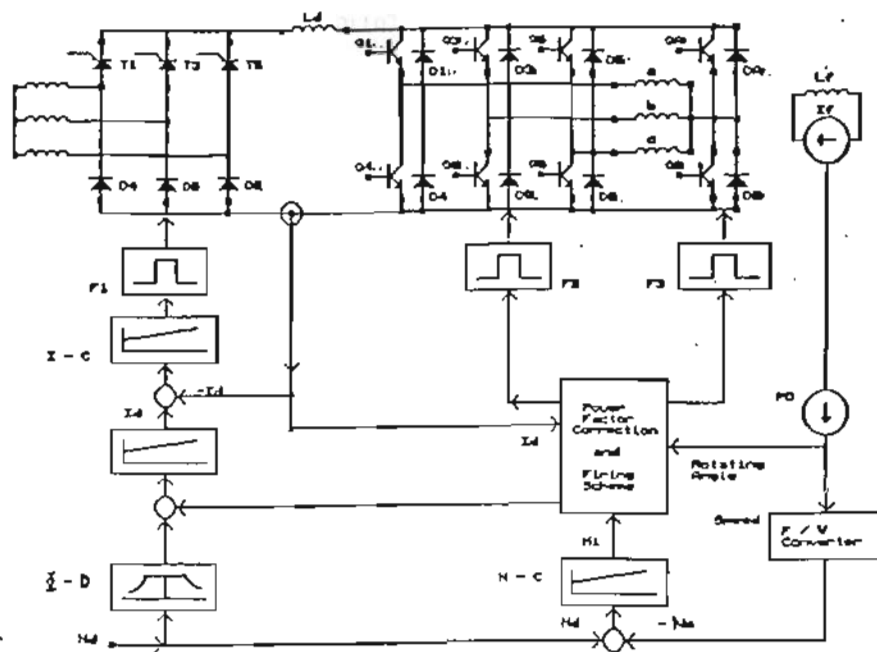

Fig.2. The performed drive system

2.2. Principle of the Control Circuit

Figure 2 shows the performed control circuit and the vector diagram of the machine is shown in Fig.3. The electromagnetic torque of the machine depends on the phase current I_s (dc link current I_d), the magnetic excitation (replaced by a fictitious field current I_f), and the displacement angle δ_s between these two vectors. The relation may be written in the form:

$$M_i = K_m \cdot I_s \cdot I_f \cdot \sin(\delta_s) \quad (1)$$

From which, the displacement angle δ_s (angle of field) can be calculated as

$$\delta_s = \arcsin \left[\frac{M_i}{K_m \cdot I_s \cdot I_f} \right] \quad (2)$$

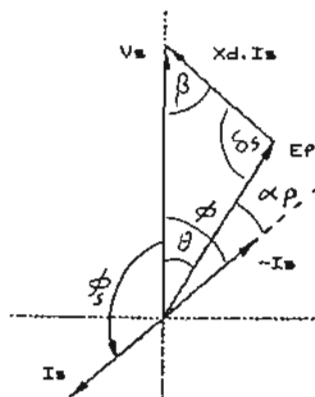

Fig.3 The Vector-diagram

As shown in Fig.3 and Fig.4, the output of the speed controller N-C is assumed to be proportional to the induced torque given by Eq.1. Dividing this value by the product of the measurable value of the stator current I_S ($\sim I_d$) and the given fictitious field current I_f , then the mettle value of the displacement angle δ_S can be obtained using Eq.2. As seen from the vector diagram shown in Fig.2 (overlap is neglected) the phase angle ϕ_S for motor operation is given by:

$$\phi_S = \pi - \phi = \left[\frac{\pi}{2} + \delta_S - \theta \right] \quad (3)$$

where the angle θ is the power angle between the excitation emf E_f and machine voltage V_S and can be calculated according the relation;

$$\tan(\theta) = \left[\frac{I_S \cdot X_d \cdot \sin(\delta_S)}{E_f - I_S \cdot X_d \cdot \cos(\delta_S)} \right] \quad (4)$$

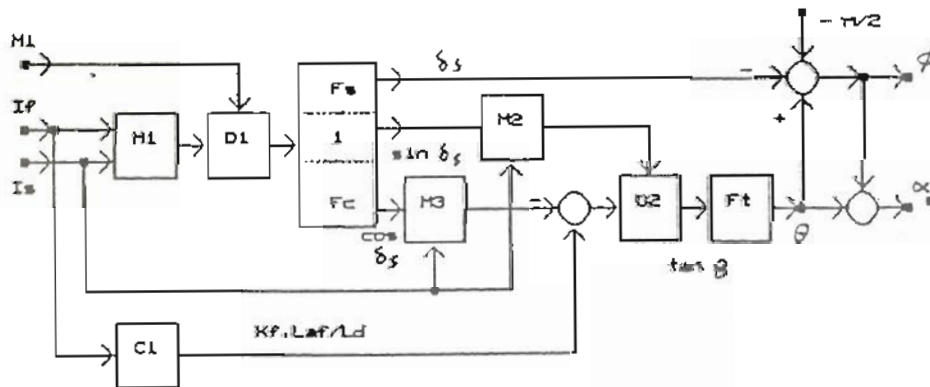

$M_{1,2,3}$: multipliers, $D_{1,2}$: Dividers, C_1 : constant
 F_S : $\arcsin(\delta_S)$, F_C : $\arccos(\delta_S)$, F_t : $\arctan(\theta)$

Fig.4 The power factor correction unit

The excitation voltage E_f of a permanent-magnet machine can be recognized as a linear function of its angular speed ω_e defined by the relation;

$$E_f = K_f \cdot L_{af} \cdot \omega_e \quad (5)$$

Using Eqs. 4 and 5, the power-angle θ can be calculated according to;

$$\tan(\theta) = \left[\frac{I_S \cdot \sin(\delta_S)}{K_f \cdot (L_{af}/L_d) - I_S \cdot \cos(\delta_S)} \right] \quad (8)$$

The inverter firing angle α_θ corresponding to the excitation voltage E_f as shown in Fig.2 is given by;

$$\alpha_\theta = \phi - \theta \quad (7)$$

In order to define the firing angle of the supply rectifier, the desired value of the air-gap field is obtained from the set value of the speed through the field definer Φ -D, where its actual value is calculated from the phase-currents and phase-voltages. The difference gives the desired current in the dc link through the field controller Φ -C. The current controller I-C compares this desired value with the measured actual current and gives an output proportional to the firing angle of the supply converter. The performed three controllers are of the Proportional-Integral types to eliminate any differences between the desired and the measured (or calculated) values.

2.3 Calculation of the phase voltage

Estimation of the amplitude and phase of the phase voltage, which is needed to calculate the air-gap field, can be obtained as follows:

Once the rotor position is known, the instantaneous values of the excitation voltage e_f and the phase voltage v_s can be obtained according to the two relations;

$$e_f = \sqrt{2} \cdot E_f \cdot \sin(\omega_\theta \cdot t) \quad (8)$$

$$v_s = \sqrt{2} \cdot V_s \cdot \sin(\omega_\theta \cdot t \pm \theta) \quad (9)$$

where the positive sign is for motor operation and the negative for generator operation. Also the rms value of the phase voltage V_s can be obtained from the vector diagram in Fig.2 by the trigonometric relation;

$$\left[\frac{V_s}{\sin(\delta_s)} \right] = \left[\frac{E_f}{\sin(\theta)} \right] \quad (10)$$

or by reforming this function the amplitude of the phase voltage is;

$$V_s = \left[\frac{\sin(\delta_s)}{\sin(\theta)} \right] \cdot E_f \quad (11)$$

2.4. Firing Pulses for the Inverter:

The rotor position is detected using a very simple incremental shaft encoder operates by translating the rotation of the shaft into

interruptions of two light beams which are then output as electrical pulses. Counting this pulses with respect to a given point (axes of phase-a), the shaft position is always known.

Figure 5.a shows the block diagram to obtain the firing pulses. The output pulses of the shaft encoder (position of the excitation voltage E_p) are manipulated together to give the dual number given by eight signals P_0 to P_7 . The firing angle α_0 (analogue voltage) corresponding to the emf is also converted into other eight dual signals and then added to the forgoing pulses in order to get the dual number corresponding to the rotating angle of the phase-currents. These final signals are manipulated together to get the needed firing pulses [2].

The firing pulses of the zero transistors Q_A and Q_B in Fig.3 are found by very simple circuit. The square pulses corresponding to the positive half-waves of the phase currents (pulses of transistors T1, T3, and T5) and the square waves corresponding to the negative phase voltages half-waves are manipulated with AND gates and then ORed with three diodes to give the firing pulses for the transistor Q_A . The same way is followed to get the firing pulses for the transistor Q_B using the other half-waves of the voltages and the currents. The implemented circuit is shown in Fig.5.b.

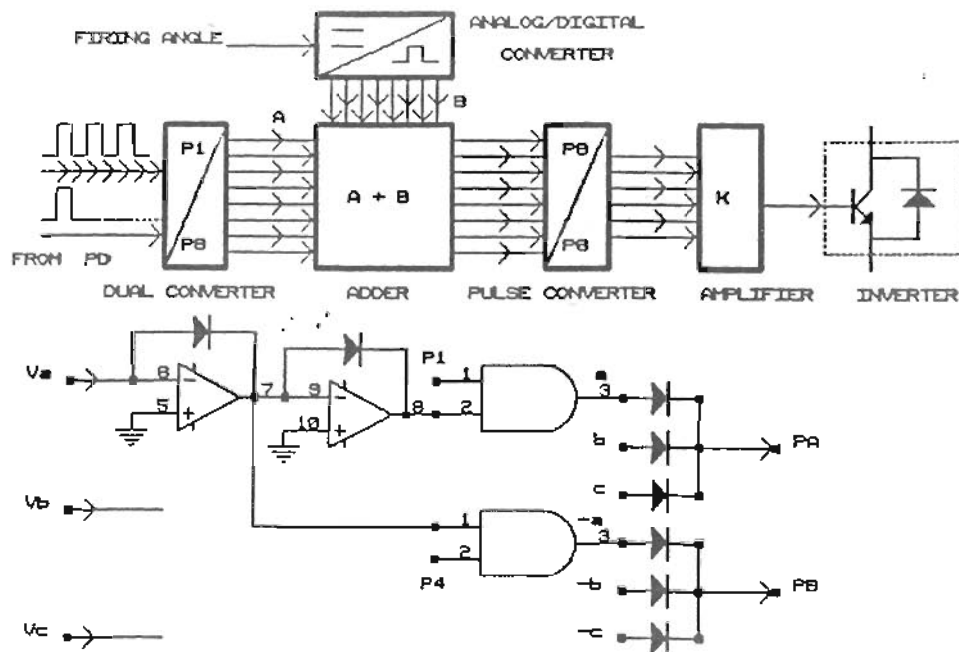

Fig.5 Firing Circuit for the Inverter

3. EXPERIMENTAL RESULTS

3.1. The System Parameters

The power part of the implemented system consists of the following parts:

a. The Synchronous machine:

The machine used is a small permanent-magnet three phase tachogenerator with the following parameters:

Number of Poles	4	Poles	Rated Speed	1500 rpm.
Rated Power	110 VA.	Rated Phase voltage	220 volt	
Rated Phase Current	0.4 amp.			

b. The Current Source:

Thyristors Type	TO 48	Diodes Type	1N54043A
Inductor	20 mH.		

c. The Inverter:

Darlington Transistor Type GE 6252: 450 V, 10 A, $\beta_{min} = 100$

The steady-state and dynamic performances of the implemented drive system are given in the following lines.

3.2. Steady-state performances;

The following curves are measured:

Fig.6 shows the per unit relation $M_1 = f(\delta_s)$ with stator current I_s as parameter at a speed of 1000 rpm.

Fig.7 The same curves as in Fig.6 but for a speed of 200 rpm.

Fig.8 shows the per unit relation $I_s = f(\delta_s)$ with airgap field Φ_s as parameter at a speed of 1000 rpm.

Fig.9 The same curves as in Fig.8 but at a speed of 200 rpm.

The displacement angle δ_s is defined by changing the dc link current through loading the machine. The value of the airgap field Φ_s is fixed through changing the amplification factor between the speed and the airgap field Φ_s .

The effect of the additional Zero Transistors is illustrated through measuring the following two curves:

Fig.10 shows the relation $\phi_s = f(I_s)$ with speed N parameter.

Fig.11 shows the relation $\phi_s = f(N)$ with current I_s parameter.

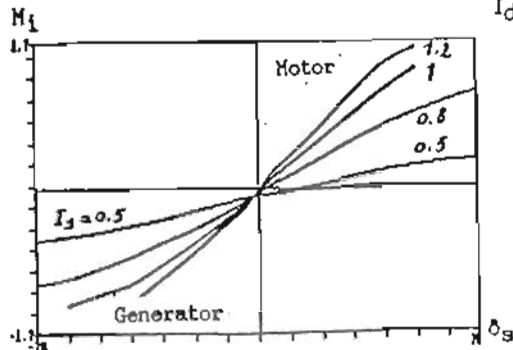

Fig. 8

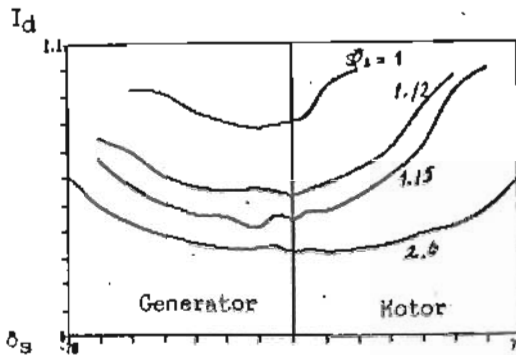

Fig. 9

scale step: $\delta_s : 10^\circ$, $M_i : 0.1$ pu, $I_d : 0.1$ pu, $N = 1000$ rpm

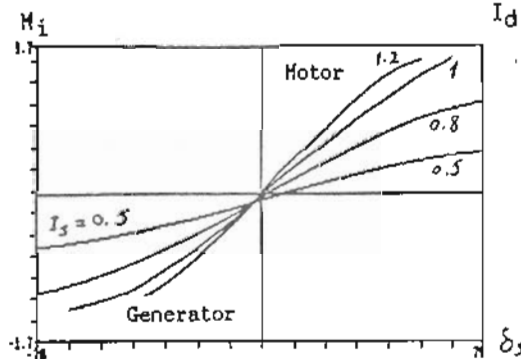

Fig. 7

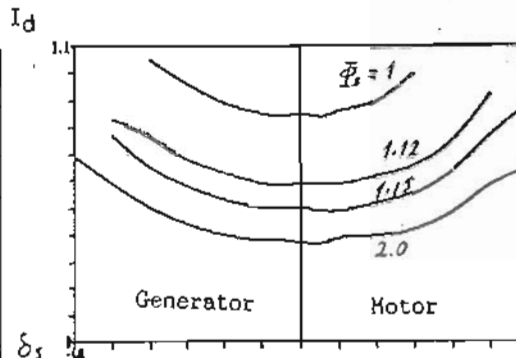

Fig. 8

scale step: $\delta_s : 10^\circ$, $M_i : 0.1$ pu, $I_d : 0.1$ pu, $N = 200$ rpm

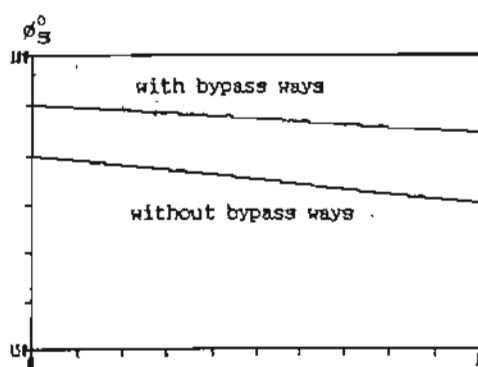

Fig.10 $n = 1$

scale step: $I_d : 0.1$ pu, $N : 0.1$ pu, $\phi_s : 5^\circ$

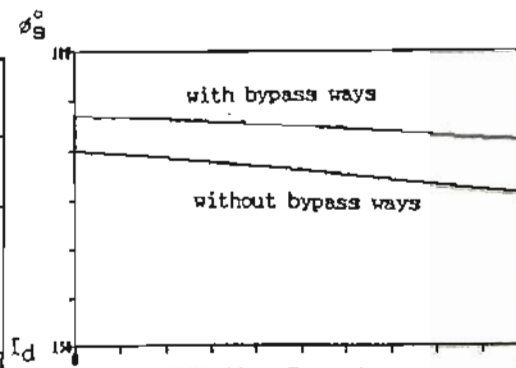

Fig.11 $I_d = 1$

3.3. Transient performances;

The following oscillograms are taken up:

The load (dc machine) is changing suddenly and the dc link current I_d , the speed N and the calculated airgap field Φ_s are recorded in the oscillograms of Fig.12 and Fig.13 respectively. The change in the speed is negligible as seen from the under traces. The oscillogram of Fig.14 shows the changes of the calculated machine voltages in the α -direction $V_{\alpha s}$ and the dc link current I_d , at speed of 500 rpm where the machine is suddenly loaded by full load. In the oscillogram of Fig.15 the load is suddenly relieved.

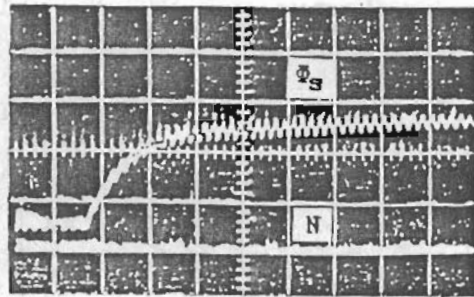
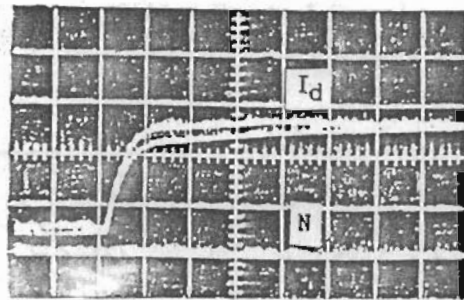

Fig.12

Fig.13

scale step: time : 100 ms,
speed : 500 rpm

current: 100 mA
flux : 0.5 pu

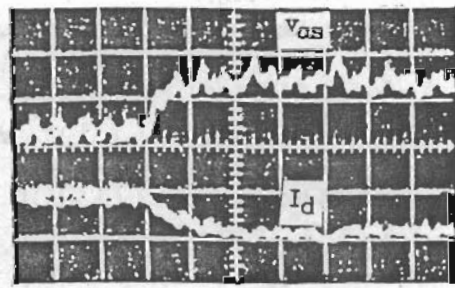
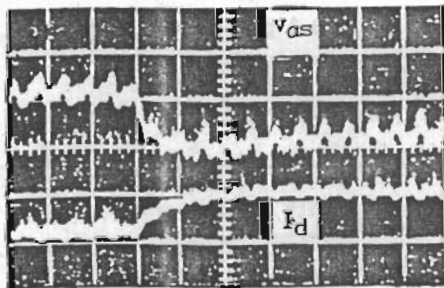

Fig.14

Fig.15

scale step: time : 100 ms,
speed = 500 rpm

current: 400 mA
voltage: 50

4. CONCLUSION

From the above recorded results and the noticeable running of the system, the following remarks were noted:

Due to the zero-transistors, the power factor is slightly improved but still less than unity. Also the overlap angle was neglected in calculating of the phase voltages but these voltages and the measured phase current are practically enough to define the airgap field and the firing angle of the inverter. At last, it is possible to remark that the control circuit is suitable for the implemented drive system and the same principle of power factor correction can be performed by systems containing high power conventional synchronous machines using naturally commutated thyristorized rectifier-inverter sets.

5. REFERENCES

- [1] Salah Gh. Ramadan; "Die Synchronmaschine mit Speisung und Regelung über "Gleichstrom-zwischenkreisrichter einschliesslich des Feldschwächerbereiches"; Diss. Darmstadt 1983-BRD.
- [2] Salah Gh. Ramadan and M. A. Morsy Shanab; "Firing scheme of self-controlled synchronous machine drive"; Scientific Bulletin, Ain Shams University, Faculty of Engineering, No. 19, Jan. 1987.
- [3] P. Zimmermann; "Über und untersynchrone Stromrichter-kascade als schneller Regelantrieb"; Diss. Darmstadt BRD 1978.
- [4] R.Jötten; "Leistungselektronik, Band I, Vieweg-Verlag, Wiesbaden 1971.
- [5] A. Jakubowicz and J. P. Rognon; "Self - Controlled Synchronous Servodrive: Study of the instantaneous Torque"; ICEM, sept. 1986, pp. 544 - 549.
- [6] Eiji Yamada, Katshiro Izumi, Mineo Tsuji and Jun Oyama; "Comparison between computed and test results of a vector controlled induction motor using microprocessor"; ICEM, sept. 1986, pp.685-688.
- [7] Christian Urbanke; "Analoges Echtzeit - Maschinen- und Netzmodell für Drehstrometze und Drehstrom - Gleichstrom - Verbundnetze"; Diss. Darmstadt 1979 BRD.