



" Role Played by Hippocampal Apoptosis, Autophagy and Necroptosis in Pathogenesis of Diabetic Cognitive Dysfunction: A Review of Literature "

Authors:

- 1. Eman Mohammed Elsaed** "Assistant Lecturer of Human Anatomy and Embryology, Faculty of Medicine, Port Said University"
- 2. Ahmed Gamal Abdelghafour Hamad** "Lecturer of Human Anatomy and Embryology, Faculty of Medicine, Mansoura University"
- 3. Omnia Sameer Erfan** "Assistant Professor of Human Anatomy and Embryology, Faculty of Medicine, Mansoura University"
- 4. Mona Abd Elrahim Elshahat** "Professor of Human Anatomy and Embryology, Faculty of Medicine, Mansoura University"
- 5. Fathy Abd Elghany Ebrahim** "Professor of Human Anatomy and Embryology, Faculty of Medicine, Mansoura University"

Abstract

Cognitive dysfunction is an important comorbidity that affects diabetic patients of different types and at different ages. A wide range of cognitive deficits can occur depending on many factors such as type of diabetes, age of its onset and whether properly controlled or not.

Mechanisms of diabetic cognitive affection in children and elderly patients are relatively more obvious as compared to young or middle-aged adults. In type 1 diabetes mellitus of adults, mental agility appears to be affected rather than accuracy. In type 2 diabetes mellitus of adults, the processing of unstructured information, which depends on memory, processing speed, and executive function, shows more noticeable affection.

This review addresses the possible role played by apoptosis, autophagy and necroptosis in the hippocampus of diabetic patients, which may provide an explanation for the diabetic cognitive dysfunction.

Key words: Diabetes mellitus, cognition, hippocampus, apoptosis, autophagy, necroptosis.

1. Introduction

Cognitive deficits associated with diabetes vary between attention, learning, memory, psychomotor speed and executive function. These deficits are also accompanied by structural changes in gray matter, white matter or cerebral perfusion. The type of diabetes, age of its onset, associated microvascular complications and the glycemic state are factors that can determine the type and degree of cognitive deficit (Holt, 2020).

Hippocampus is considered a vulnerable structure that can be damaged by a variety of stimuli, allowing it to be extensively studied in several neuropsychiatric disorders. In early 1970s, attention was directed to the role played by the hippocampus in memory due to memory affection that resulted following its removal in a patient called Henry Gustav Molaison, who developed anterograde and partial retrograde amnesia. Studies

demonstrated that affection of memory in hippocampal damage is manifested as anterograde amnesia and often retrograde amnesia, but implicit memory is spared. In addition, hippocampus plays a role in spatial navigation, emotional behavior, and regulation of hypothalamic functions, since it has connections with neocortex, amygdala and hypothalamus (**Anand & Dhikav, 2012**).

Cell death and cellular response to stress are critical steps in maintaining tissue homeostasis. Dysregulation of apoptosis, necroptosis or changing autophagy to a pro-death mechanism contribute to development of diabetic complication (**Yang et al., 2017**).

2. Discussion

2.1. Burden of the problem

Diabetes mellitus (DM) represents a known health problem and economic burden worldwide. According to the International Diabetes Federation (IDF), its prevalence is expected to increase from 463 million in 2019 to 700 million in 2045 (**Diabetes atlas, 2019**). Cognitive dysfunction in DM seems to be age related, as children and older adults are most vulnerable to brain affection. Both hypoglycemia and chronic hyperglycemia can attribute to diabetic cognitive deficits. Recurrent attacks of severe hypoglycemia are of the most important factors in children cognitive affection, while diabetes-attributable risk of dementia in older people is 6–7%, which is surprisingly more related to cardiovascular risk factors associating DM rather than the glycemic state. In adults with diabetes, the mechanisms underlying the cognitive dysfunction are still not fully understood. Adults with type 1 diabetes show affection of mental agility more than accuracy, while adults with type 2 diabetes show decreased ability of processing unstructured information, which depends on memory, processing speed, and executive function (**Holt, 2020**).

2.2. Pathophysiology and pathogenesis

Following meals, a rise in blood glucose level stimulates insulin secretion. Insulin helps utilization of glucose via transportation, biotransformation and storage. Peripheral

tissues, such as skeletal muscle and adipose tissue, increase glucose transporter 4 (GLUT4) expression in the cell membrane, which is insulin dependent. However, neural tissues mediate glucose transport by GLUT1 and GLUT3, which are insulin independent (Soltésová et al., 2013; Hurrell & Hsu, 2017).

Deficient insulin leads to increase in glucose uptake in insulin independent tissues. Hyperglycemia activates many biochemical pathways, which are associated with generation of reactive oxygen species (ROS), with subsequent increase in oxidative stress and tissue damage (figure 1) (Vanessa Fiorentino et al., 2013; Asmat et al., 2016). Under normal physiological conditions, ROS are produced at low levels and scavenged by endogenous antioxidant systems. These ROS are highly reactive and can remove electrons from anything in their path, as a result, they cause damage to cells. They can destroy the cells that involve apoptotic cell injury, and can lead to apoptosis by variable cellular pathways (Maiese et al., 2007).

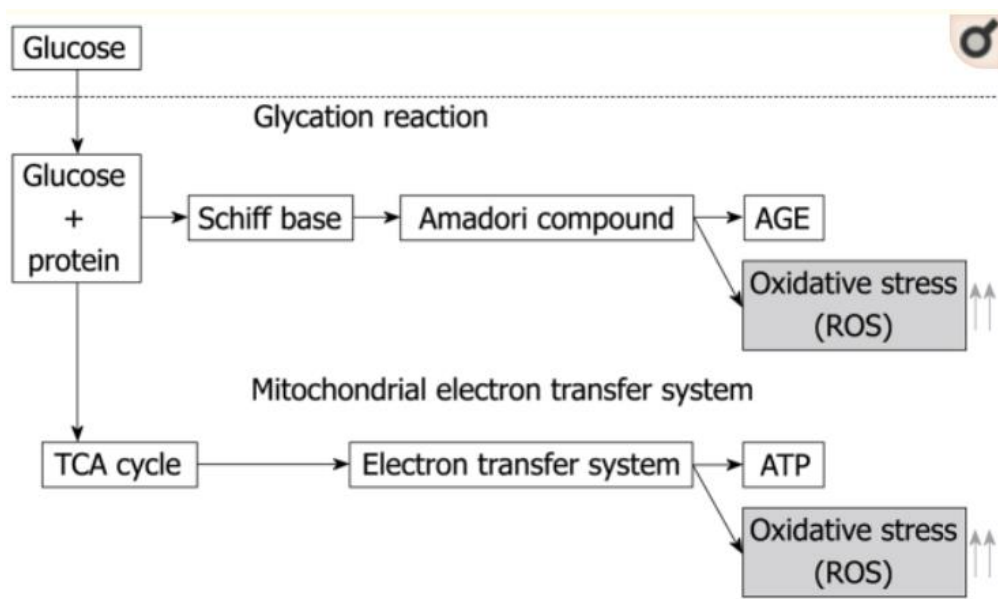

Fig. 1. A diagram showing the effect of hyperglycemia on influencing the oxidative stress in diabetes. AGE: Advanced glycosylation end products; TCA cycle: Tricarboxylic acid cycle; ATP: Adenosine tri-phosphate (Kawahito et al., 2009).

Chronic hyperglycemia is considered the chief injurious mechanism in all types of diabetes, and proper control of blood glucose level is considered the most effective way to reduce the risk for diabetic complications. Impairment of energy production in

affected cells is another major contributor to the development of diabetic complications. Diabetes leads to disturbance in the controlled burn of carbohydrates and fats because of excess substrate availability (glucose transport could be slowed for cellular self-preservation), or impaired insulin signaling. The resulting lack of intracellular glucose may cause the substrates for energy production to be shifted from glucose intermediates to substrates derived from free fatty acids (figure 2) (Forbes & Cooper, 2013).

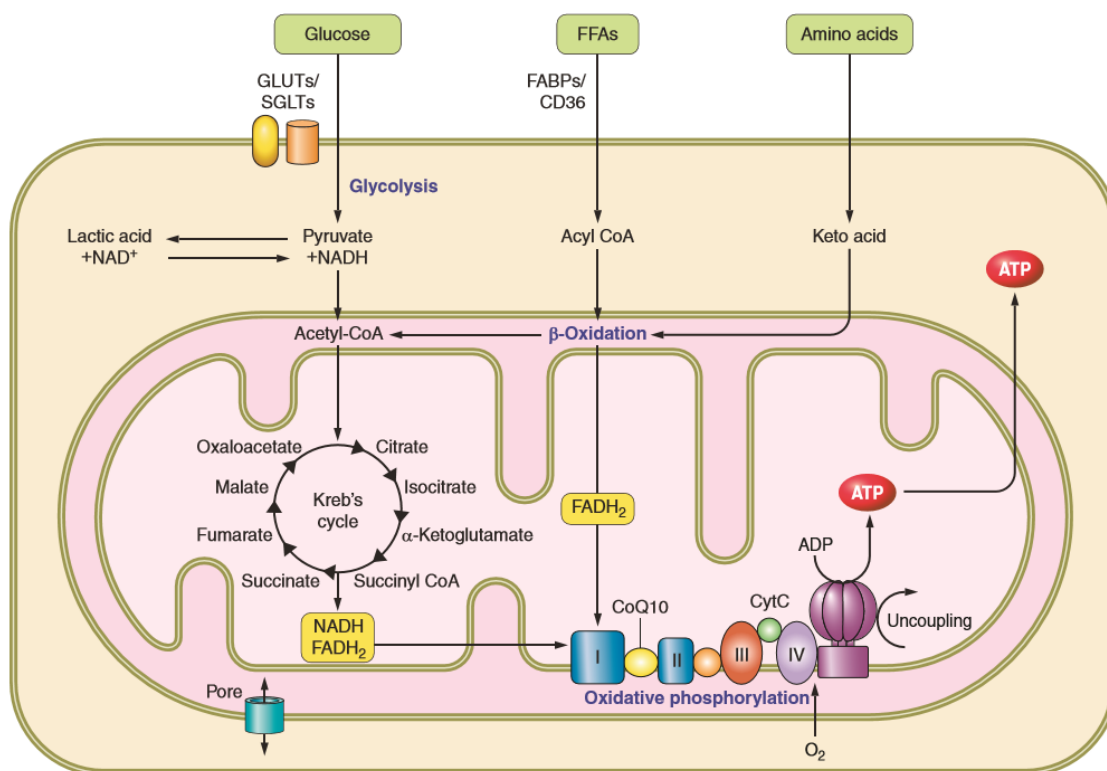

Fig. 2. Energy production within the mitochondria. NAD/H, nicotinamide adenine dinucleotide (reduced); FADH₂, flavin adenine dinucleotide (reduced); complex I (NADH dehydrogenase); complex II (succinate dehydrogenase); complex III (cytochrome c reductase); complex IV (cytochrome-c oxidase); CoA, coenzyme A (Forbes & Cooper, 2013).

Diabetic complications are believed to be consequences of a persistent hyperglycemia-induced low-grade inflammation and cellular death. Hyperglycemia activates a metabolic route, known as the dangerous metabolic route in diabetes, involving diacylglycerol (DAG)—protein kinase C (PKC)—and NADPH-oxidase, resulting in accumulation of ROS. ROS production is induced through mitochondrial respiratory chain enzymes. Under these conditions, cells become susceptible to

necroptosis, apoptosis, necrosis, and disturbances in autophagy. Many studies suggested that the inhibition of ROS production would control cellular death and diabetic complications (**Volpe et al., 2018**).

2.3. Brain affection in DM

Diabetes has long-term effects on the brain, which are expressed at structural, neurophysiological, and neuropsychological levels. Multiple pathogenic pathways are involved in diabetic cerebral dysfunction that can be described as accelerated brain ageing (**Muriach et al., 2014**).

Cortical and subcortical atrophy affecting many brain regions have been associated with T2DM. This atrophy is accompanied by diminished regional cerebral perfusion and vasoreactivity that preferentially affects frontal and temporal regions (**Last et al., 2007**). The hippocampus is essentially vulnerable to hyperglycemic neurotoxicity, as patients of all ages with uncontrolled diabetes are at high risk to develop cognitive impairment and considerable hippocampal atrophy (**Fotuhi et al., 2012**). Diabetes induces neuronal loss in hippocampus by many mechanisms such as impaired hippocampal neurogenesis (**Ho et al., 2013**), altered autophagy markers and decreased mitochondrial biogenesis (**Carvalho et al., 2015**), and apoptosis (**Sadeghi et al., 2016**).

Glucose has been considered to be the main neuronal energy source for a long time. Many studies proved that monocarboxylates, such as lactate, are another important energy source for the neurons. Moreover, it could be preferred over glucose, if both substances are available (**Wyss et al., 2011**).

Lactate is derived from peripheral circulation via the blood brain barrier (BBB), or through glycolysis and/or glycogenolysis by astrocytes. The glycogen-derived lactate pathway is known as astrocyte-neuron lactate shuttle (ANLS), which is mediated by monocarboxylate transporter 2 (MCT2). Studies suggest that ANLS disruption makes the hippocampus more vulnerable to T2DM than other brain regions (**Shima et al., 2018**).

Effect of diabetes on the brain results from hyperglycemia and its associated comorbidities such as hyperinsulinemia, hypertension and dyslipidemia. Researchers

identified both neuronal and non-neuronal dependent pathways for diabetic brain affection. Neuronal dependent pathway is represented by direct changes in gene expression and transcription, hyperosmolarity with increased vasopressin and hypothalamic degeneration, and a direct effect on the calcium balance in the hippocampus leading to its degeneration. Non-neuronal dependent pathway is represented by altered response to oxidative stress, abnormal vascular structure and function, and increased O-linked glycoprotein and AGES, which may promote amyloid toxicity to microglia and astrocytes. On the other hand, hypoglycemic events cause disturbance of the nutrients delivered to the brain, and accumulation of the neurotoxic glutamate. Eventually, diabetes cause neurodegeneration with various mechanisms, and neurodegeneration impairs the glucose regulation creating a vicious cycle of affection and deterioration (**Launer, 2005**).

Another important factor of brain affection is the damage to BBB. This damage leads to alteration of the transport functions, disturbance in the integrity of tight junctions, and oxidative stress in the CNS micro-capillaries (**Prasad et al., 2014**).

2.4. Cell death pathways

Cells are continuously subjected to a wide range of potentially fatal insults, which may eventually lead to cell death. Cell death can be accidental or programmed cell death (PCD). Accidental cell death or necrosis usually results from exposure of the cell to hazardous conditions that cannot be modulated. On the other hand, PCD results from stimulation of variable genetically encoded pathways directed primarily to maintain cell homeostasis, and are regarded as vital adaptive strategies (**Kim-Campbell et al., 2019**).

2.4.1. Apoptosis

Apoptosis is an ordered cellular process that describes a situation in which a cell actively follows a series of signal cascades toward death after receiving certain stimuli. It occurs in both physiological and pathological conditions. It plays a vital role in clearing abnormal cells, and maintaining a constant number of cells. Disturbance of apoptosis plays a role in the pathogenesis of many conditions; too much apoptosis occurs in degenerative diseases, and too little apoptosis occurs in cancer (**Wong, 2011**).

Caspases are members of the interleukin-1 β -converting enzyme family. Fourteen caspases have been identified, which share some properties such as: they are aspartate-specific cysteine proteases; they possess a conservative pentapeptide active site; their precursors are zymogens known as pro-caspases; and they have the ability of autoactivation as well as activating other caspases. According to the amino acid sequence, they are divided into three subfamilies: apoptosis activator, apoptosis executioner and inflammatory mediator caspases. The procaspases of the apoptosis activator and the inflammatory mediator caspases have long prodomains that contain the death effector domain (DED) in procaspase-8 and -10, or the caspase recruitment domain (CARD) in procaspase-2 and procaspase-9. Apoptosis executioner caspases, such as caspase-3, have shorter prodomains (**Fan et al., 2005**).

Activation of procaspases can occur via either the extrinsic pathway (death receptor-mediated apoptosis), or the intrinsic pathway (stress-induced, mitochondrial-mediated apoptosis). The extrinsic pathway is activated by binding of the Fas ligand, tumor necrosis factor α (TNF- α), or TNF-related apoptosis-inducing ligand (TRAIL) to the death receptors. A complex named death-inducing signaling complex (DISC) is formed between procaspase-8 and Fas-associated death domain (FADD). This complex activates procaspase-8, which induces apoptosis by activation of caspase-3, or cleavage of Bid (a pro-apoptotic Bcl-2 family member) to truncated Bid (tBid) that activates the intrinsic pathway (figure 3) (**Chen et al., 2018**).

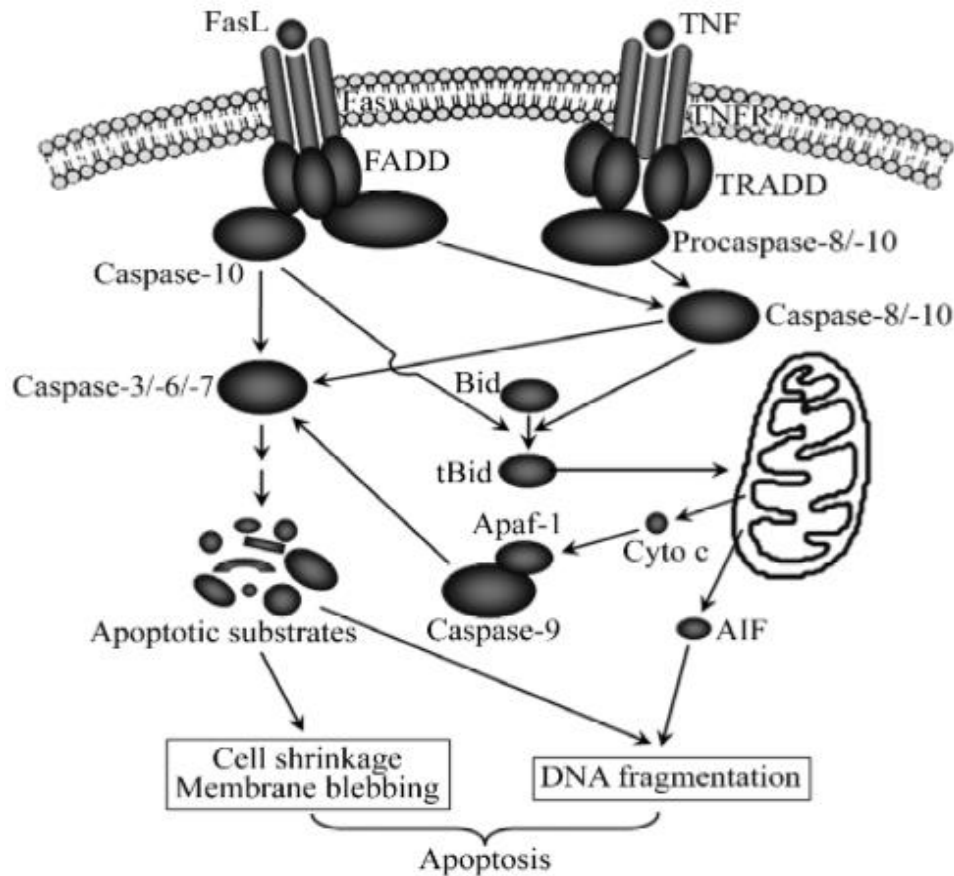

Fig. 3. The extrinsic pathway. FADD, Fas-associated death domain; TRADD, TNF receptor-associated death domain; AIF, apoptosis-inducing factor; Apaf-1, apoptotic protease activation factor-1; Cyto c, cytochrome c (Fan et al., 2005).

The intrinsic pathway is activated by several cellular stresses such as DNA damage, oxidative stress, growth factor deprivation, and endoplasmic reticulum (ER) stress. These stresses cause the loss of mitochondrial transmembrane potential and the release of a number of proteins including cytochrome c (Cyto c) and second mitochondria-derived activator of caspases (SMAC). Without the need of forming the death-inducing signaling complex (DISC), Cyto c join the apoptotic protease activation factor-1(Apaf-1), pro-caspase 9 and dATP forming a complex named apoptosome. The apoptosome activates caspase-9, which in turn activates caspase-3 and caspase-7 (apoptosis executioner caspases) causing proteolysis (figure 4) (Lalaoui et al., 2015).

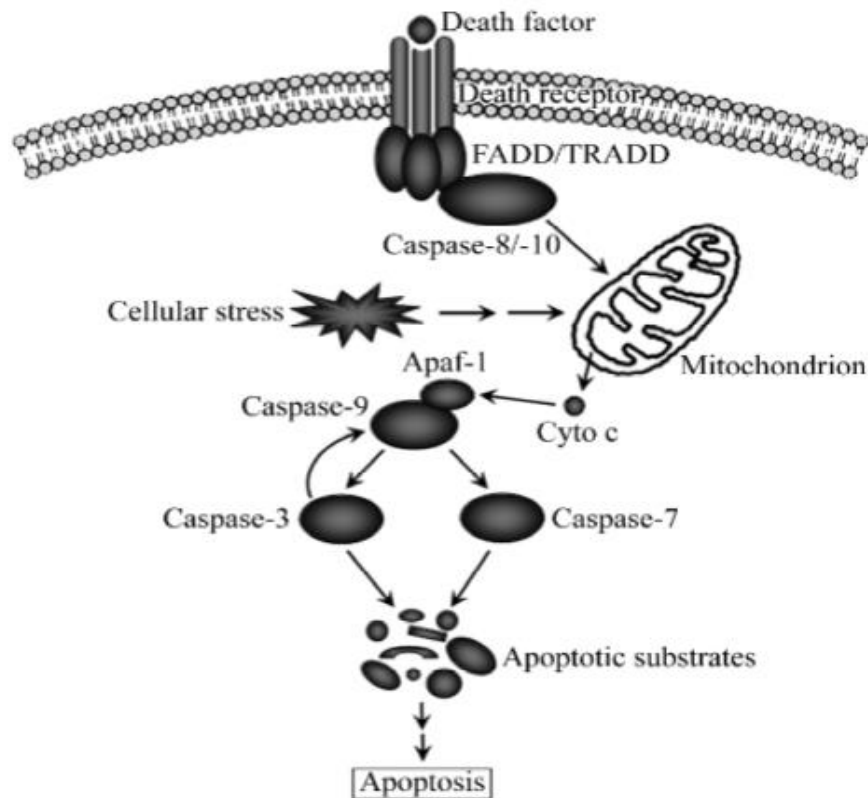

Fig. 4. The intrinsic pathway. FADD, Fas-associated death domain; TRADD, TNF receptor-associated death domain; Apaf-1, apoptotic protease activation factor-1; Cyto c, cytochrome c (Fan et al., 2005).

Apoptosis is involved in the pathophysiology of diabetic complications. Endothelial dysfunction is an important factor in the pathogenesis of microvascular and macrovascular diabetic complications. The endothelium in DM displays many changes in its properties including sensitivity to apoptosis. Hyperglycemia is believed to be able to induce endothelial cell apoptosis by many mechanisms such as oxidative stress, increased intracellular Ca^{2+} , changes in intracellular fatty acid metabolism, mitochondrial dysfunction, activation of mitogen activated protein kinases (MAPK) signaling pathways, and impaired activation of the protein kinase B (Akt) that can protect cells from apoptosis (van den Oever et al., 2010).

Diabetes is evidenced to induce cognitive impairment and hippocampal neuronal apoptosis. In a study using STZ-induced diabetic rats, results demonstrated the presence of ultrastructural changes of the hippocampal neurons, and a decrease in the number of hippocampal synapses. These changes resulted in the impairment of neural connectivity,

and functional and morphological injury of hippocampal synaptic plasticity. Endoplasmic-reticulum stress-mediated apoptosis was responsible for the hippocampal neuronal loss (**Zhang et al., 2013**).

2.4.2. Autophagy

Autophagy is the mechanism by which eukaryotic cells can get rid of intracellular organelles and protein aggregates that cannot be degraded by the proteasome, and deliver them to lysosomes for degradation. Two major systems are responsible for degradation of cellular components: the ubiquitin-proteasome system and autophagy. The ubiquitin-proteasome system degrades short-lived proteins, as they are tagged by ubiquitin (a small protein modifier conjugated to target proteins to regulate many biological processes) and recognized and degraded by the proteasome, while autophagy depends on a lysosome-driven process to degrade long-lived proteins, lipids, and cytoplasmic organelles (**Ikeda & Dikic, 2008; Gukovskaya & Gukovsky, 2012**).

Autophagy has three different types: chaperone-mediated autophagy, microautophagy and macroautophagy which is known as autophagy. In chaperone-mediated autophagy, unfolded soluble proteins are directly translocated across the limiting membrane of the lysosome in a complex with chaperone proteins. In microautophagy, cytosolic components are directly engulfed by invagination of the lysosomal membrane. While in macroautophagy, cytoplasmic cargo is delivered to the lysosome through autophagosome (**Glick et al., 2010**).

The process of autophagy involves four ordered steps: initiation, nucleation, fusion of autophagosome and lysosome, and hydrolyzation (figure 5). Morphologically, the first step is the nucleation that involves the formation of the phagophore, which is an isolation membrane. The autophagosome is formed by elongation of the phagophore and fusion of its edges, resulting in a double-membraned structure holding cytoplasmic content. The outer membrane of the autophagosome fuses with a lysosome giving an autolysosome, in which the inner membrane and engulfed material are hydrolyzed (**Ma et al., 2017**).

The rate of turnover of autophagic vacuoles is referred as autophagic flux that largely depends on the formation and degradation of autolysosomes. Lysosomes are the key organelles that regulate all steps following autophagosome formation. They contain acid hydrolases that are capable of breaking down any biological material. Lysosomal integrity is influenced by soluble acid hydrolases and lysosomal membrane proteins (Gukovskaya & Gukovsky, 2012).

Autophagy is a genetically-controlled conserved process that is regulated by a number of gene products named autophagy (Atg)-related proteins. One subset of these proteins, termed the core molecular machinery, is important for autophagosome formation. The proposed site for autophagosome formation is termed the phagophore assembly site (PAS) (Yang & Klionsky, 2010; Chen et al., 2018).

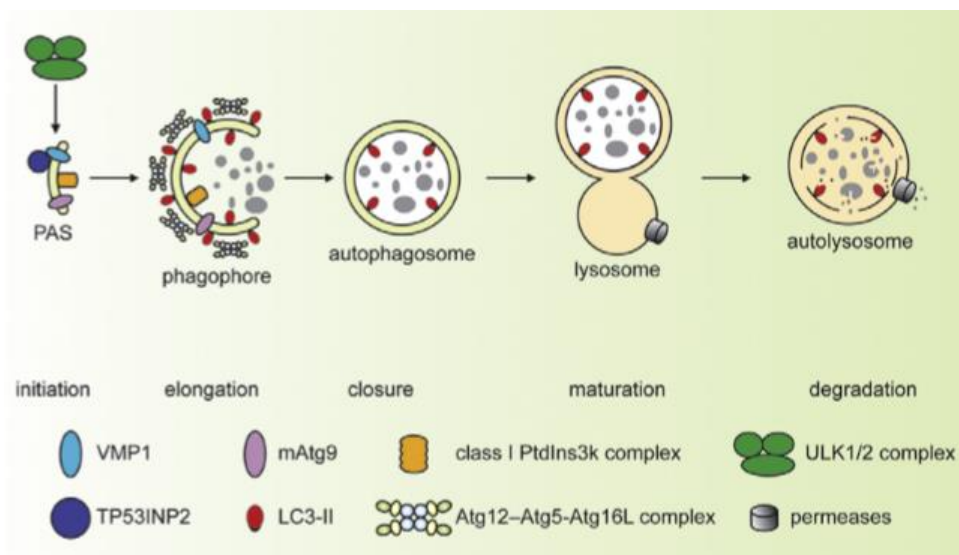

Fig. 5. Schematic depiction of the steps of autophagy. PAS, phagophore assembly site; mAtg9, membrane protein Atg9; PtdIns3k, phosphatidylinositol 3-kinase; VMP1, vesicle membrane protein (Yang & Klionsky, 2010).

The enhancement of autophagy is critical for cell survival, as it permits active rearrangement of nutrients from less vital to more vital processes. It supplies nutrients from endogenous energy sources, preserving the homeostasis of cell function under different stressful conditions (Watada & Fujitani, 2015). However, many factors can affect the autophagic activity such as the type of diabetes and the predominating metabolic alteration (Li et al., 2017). The association of DM with impairment of

autophagic flux was reported by some studies, which attributed this impairment to lysosomal dysfunction (Yuan et al., 2019).

The mammalian target of rapamycin complex 1 (mTORC1) is considered a critical point in the activation of autophagy in response to different cellular stressors. Under normal conditions, activated mTORC1 negatively regulates autophagy initiation. However, under starvation or energy depletion, many upstream regulators function to inhibit the mTORC1, thus activating the autophagy machinery (figure 6) (Marasco & Linnemann, 2018).

Autophagic cell death was defined by The Nomenclature Committee on Cell Death as “a cell death subroutine that is limited or delayed by the pharmacologic or genetic inhibition of the autophagic machinery” (Lalaoui et al., 2015). Although autophagy works as a pro-survival mechanism, over-stimulation can change it to a pro-death mechanism causing the cells to progress to autophagic cell death (Yang et al., 2017).

Autophagy can be activated in the pathway of intrinsic apoptosis, and there is a crosstalk between it and extrinsic apoptosis (Gonzalez et al., 2011). However, a form of cell death named “autosis” was discovered, which is an autophagy gene-dependent non-apoptotic form of cell death (Liu & Levine, 2015).

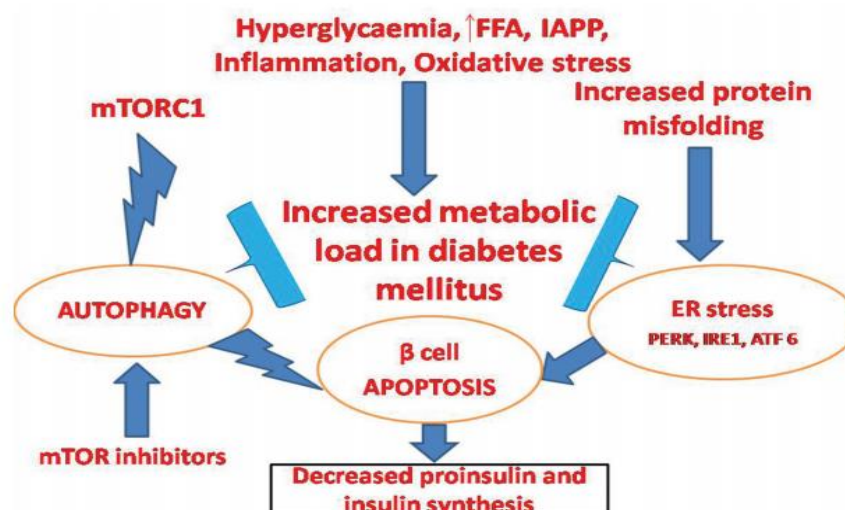

Fig. 6. An illustration of the relation between ER stress, apoptosis & autophagy (Demirtas et al., 2016).

Autophagy plays a neuro-protective role in many neurodegenerative diseases, as it shares in the elimination of accumulated cytotoxic protein in the brain. Diabetes-associated cognitive decline (DACD) induces autophagy activation, which represents an acute response of damaged hippocampal neurons to accumulated toxic substances, such as abnormally folded proteins, impaired mitochondria, and ROS. However, the mitochondria mediate microtubule conformational changes resulting in axonal transport barriers, so, autophagosomes are not capable of fusing with the lysosome in the axon. Consequently, the neuro-protective role played by autophagy in DCAD may be limited to the early stage of the disease (**Wu et al., 2019**). In addition, the impairment of hippocampal autophagic flux causes cognitive impairment, and the restoration of it may be neuroprotective (**Kang et al., 2020**).

2.4.3. Necroptosis

Necroptosis is an inflammatory, receptor-interacting protein (RIP)-dependent programmed cell death. It is distinct from apoptosis (caspase-mediated programmed cell death), and necrosis (accidental passive cell death of unregulated nature). It is a regulated necrotic cell death characterized by involvement of many molecules and processes acting as initiators, modulator or effectors. Examples of these molecules include RIP1, RIP3, caspase inhibitors, deubiquitylating enzymes, ROS, and bioenergetic reactions such as glycogenolysis (**Vandenabeele et al., 2010; LaRocca et al., 2016**).

Variable triggers can activate necroptosis, and according to the main driving force, it can be classified into extrinsic necroptosis stimulated by $TNF\alpha$, ROS-mediated intrinsic necroptosis and ischemia-mediated intrinsic necroptosis (**Dhuriya & Sharma, 2018**). Although many common triggers can initiate apoptosis and necroptosis, the intracellular signaling pathways differ between the two processes. While caspases are the key mediators of apoptosis, RIPs are essential mediators in necroptosis. Also, one of the caspases (caspase-8) has the ability to antagonize necroptosis by inactivating its mediators (**Khoury et al., 2020**).

The classical type of necroptosis is the TNF α -mediated type (figure 7). It binds with complementary receptor resulting in the formation of a short-lived membrane signaling complex (complex I) containing TRADD, FADD, RIP1, TRAF2/TRAF5, and cIAP1/cIAP2. The binding of TNF α to TNF-receptor1 (TNFR1) recruits RIP1, cellular inhibitor of apoptosis protein (cIAP), TRADD, and TNFR-associated factor (TRAF). If RIP1 is polyubiquitinated by cIAP1 and TRAF, it induces the formation of a stable complex I and initiates a cell survival pathway through the NF- κ B pathway. NF- κ B signal pathway has a role in counteracting the cytotoxic effect of TNF α , which is mediated by cIAP1/2 and cFLIP_L (cellular FLICE-like inhibitory protein) **(Dhuriya & Sharma, 2018; Gong et al., 2019)**.

If the proteins in complex I are altered, RIP1 is deubiquitinated by CYLD (a deubiquitinase that acts as a necroptosis mediator) activating cell death pathways. Complex II is formed of RIP1, TRADD, FADD, and caspase 8. RIP1 and RIP3 are among the substrates of caspase-8, and their cleavage deactivates their kinase activity. If caspase 8 is activated, the caspase cascade is initiated leading to apoptosis. If caspase 8 is inhibited by genetic or pharmaceutical intervention, necrosome is formed leading to necroptosis **(Gong et al., 2019)**.

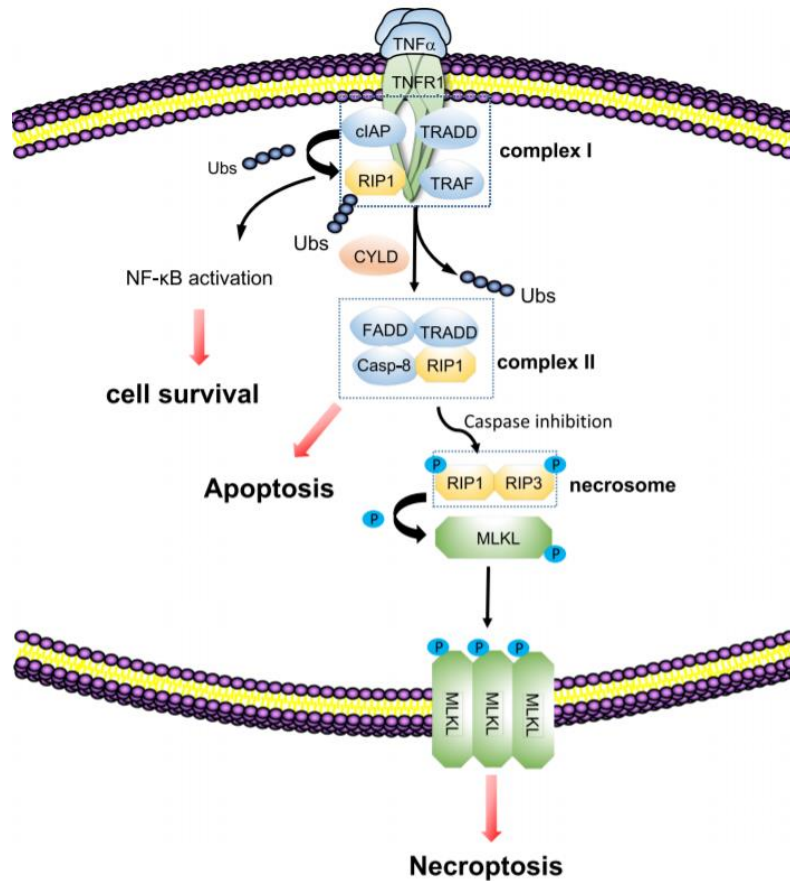

Fig. 7. A diagram showing TNF necroptosis signaling mechanism. TNF α , tumor necrosis factor- α ; TNFR1, tumor necrosis factor receptor 1; TRADD, TNFR-associated death domain; TRAF, TNFR-associated factor; cIAP, cellular inhibitor of apoptosis protein; RIP1, receptor-interacting protein 1; Ubs, ubiquitination; NF- κ B, nuclear factor kappa B; CYLD, deubiquitinase cylindromatosis; FADD, FAS-associated death domain; MLKL, mixed lineage kinase domain-like protein (Gong et al., 2019).

An important step in the pathway of necroptosis is the formation of a multiprotein cytoplasmic signaling complex known as “necrosome”. It is highly regulated by ubiquitylation and phosphorylation of RIP1 and RIP3. Both RIP1 and RIP3 have kinase activities. Blocking the kinase activity of RIP1 by small molecules termed “necrostatins” can inhibit necroptosis (Vandenabeele et al., 2010; Liu et al., 2014). The intracellular localization of the necrosome is still unclear, but it is suggested that it is initially formed in the cytosol, then it migrates to the detergent-insoluble organelles, such as ER, Golgi apparatus, and mitochondria-associated membranes. Also, it was proved that RIP3 and MLKL are nucleo-cytoplasmic shuttling proteins, as they are

activated in the nucleus, and after nuclear export, they share in cytosolic necrosome formation (**Weber et al., 2018**).

Necroptosis has been proved to have a role in the pathophysiology of diabetic complications. When H9c2 cardiac cells were exposed to hyperglycemia, the expression level of RIP3 was enhanced. Furthermore, co-treatment with necrostatin-1 (tryptophan-based molecules that inhibit the kinase activity of RIP1, discovered during a chemical screening for necroptosis antagonists) attenuated the increased expression level of RIP3 and the hyperglycemia-induced injury and inflammation (**Liang et al., 2017; Khoury et al., 2020**). Necroptosis is also found to be involved in diabetic kidney disease. In a mouse model of diabetic nephropathy, RIP3 was shown to be related to the development of renal fibrosis, and its inhibition resulted in renoprotection (**Shi et al., 2020**).

In a global cerebral ischemia/reperfusion (I/R) model, the CA1 hippocampal neurons showed an elevated level of RIP3, and the relative contribution of oxidative stress versus Ca^{2+} homeostasis and the tissue environment influenced the role played by necroptosis in I/R injury. Moreover, a mechanistic contribution of RIP1 kinase in neurodegenerative diseases is suggested, since necrostatin-1 was reported to protect against excitotoxicity in a mouse hippocampal cell line and in a primary rat cortical culture (**Zhou & Yuan, 2014**).

Administration of STZ leads to learning and memory impairment via various mechanisms including neuroinflammation. The increased production of proinflammatory cytokines activated the necroptosis pathway. RIP1 and RIP3 levels were elevated in the hippocampi of the STZ-induced diabetic rats. The introduction of a neuroprotective peptide, apelin, reduced the hippocampal RIP1, RIP3, and TNF- α levels. It reversed the neuroinflammation-induced behavioral impairment (**Nasser et al., 2020**).

3. Conclusion

This review demonstrated that each of apoptosis, autophagy and necroptosis has a role in development of diabetic cognitive dysfunction. These findings need to be more elucidated by studying the molecular mechanisms underlying these processes.

References

1. Anand, K. S., & Dhikav, V. (2012). Hippocampus in health and disease: An overview. *Annals of Indian Academy of Neurology*, 15(4), 239.
2. Asmat, U., Abad, K., & Ismail, K. (2016). Diabetes mellitus and oxidative stress—a concise review. *Saudi Pharmaceutical Journal*, 24(5), 547-553.
3. Carvalho, C., Santos, M. S., Oliveira, C. R., & Moreira, P. I. (2015). Alzheimer's disease and type 2 diabetes-related alterations in brain mitochondria, autophagy and synaptic markers. *Biochimica et Biophysica Acta (BBA)-Molecular Basis of Disease*, 1852(8), 1665-1675.
4. Chen, Q., Kang, J., & Fu, C. (2018). The independence of and associations among apoptosis, autophagy, and necrosis. *Signal transduction and targeted therapy*, 3(1), 1-11.
5. Demirtas, L., Guclu, A., Erdur, F. M., Akbas, E. M., Ozcicek, A., Onk, D., & Turkmen, K. (2016). Apoptosis, autophagy & endoplasmic reticulum stress in diabetes mellitus. *The Indian journal of medical research*, 144(4), 515.
6. Dhuriya, Y. K., & Sharma, D. (2018). Necroptosis: a regulated inflammatory mode of cell death. *Journal of neuroinflammation*, 15(1), 199.
7. Diabetes Atlas, 9th Edition (2019). International Diabetes Federation. Retrieved from [IDF Atlas 9th edition and other resources \(diabetesatlas.org\)](https://diabetesatlas.org/).
8. Fan, T. J., Han, L. H., Cong, R. S., & Liang, J. (2005). Caspase family proteases and apoptosis. *Acta biochimica et biophysica Sinica*, 37(11), 719-727.
9. Forbes, J. M., & Cooper, M. E. (2013). Mechanisms of diabetic complications. *Physiological reviews*, 93(1), 137-188.
10. Fotuhi, M., Do, D., & Jack, C. (2012). Modifiable factors that alter the size of the hippocampus with ageing. *Nature Reviews Neurology*, 8(4), 189.

11. Glick, D., Barth, S., & Macleod, K. F. (2010). Autophagy: cellular and molecular mechanisms. *The Journal of pathology*, 221(1), 3-12.
12. Gong, Y., Fan, Z., Luo, G., Yang, C., Huang, Q., Fan, K., ... & Liu, C. (2019). The role of necroptosis in cancer biology and therapy. *Molecular cancer*, 18(1), 1-17.
13. Gonzalez, C. D., Lee, M. S., Marchetti, P., Pietropaolo, M., Towns, R., Vaccaro, M. I., ... & Wiley, J. W. (2011). The emerging role of autophagy in the pathophysiology of diabetes mellitus. *Autophagy*, 7(1), 2-11.
14. Gukovskaya, A. S., & Gukovsky, I. (2012). Autophagy and pancreatitis. *American Journal of Physiology-Gastrointestinal and Liver Physiology*, 303(9), G993-G1003.
15. Ho, N., Sommers, M. S., & Lucki, I. (2013). Effects of diabetes on hippocampal neurogenesis: links to cognition and depression. *Neuroscience & Biobehavioral Reviews*, 37(8), 1346-1362.
16. Holt, R. I. (2020). Diabetes, Depression, and Cognitive Disorders. *Diabetes Complications, Comorbidities and Related Disorders*, 687-714.
17. Hurrle, S., & Hsu, W. H. (2017). The etiology of oxidative stress in insulin resistance. *Biomedical journal*, 40(5), 257-262.
18. Ikeda, F., & Dikic, I. (2008). Atypical ubiquitin chains: new molecular signals. *EMBO reports*, 9(6), 536-542.
19. Kang, X., Li, C., Xie, Y., He, L. L., Xiao, F., Zhan, K. B., ... & Tang, X. Q. (2020). Hippocampal Ornithine Decarboxylase/Spermidine Pathway Mediates H₂S-Alleviated Cognitive Impairment in Diabetic Rats: Involving Enhancement of Hippocampal Autophagic Flux. *Journal of Advanced Research*, 27, 31-40.
20. Kawahito, S., Kitahata, H., & Oshita, S. (2009). Problems associated with glucose toxicity: role of hyperglycemia-induced oxidative stress. *World journal of gastroenterology*, 15(33), 4137-42.
21. Khoury, M. K., Gupta, K., Franco, S. R., & Liu, B. (2020). Necroptosis in the pathophysiology of disease. *The American Journal of Pathology*, 190(2), 272-285.

22. Kim-Campbell, N., Gomez, H., & Bayir, H. (2019). Cell Death Pathways: Apoptosis and Regulated Necrosis. *In Critical Care Nephrology* (pp. 113-121).
23. Lalaoui, N., Lindqvist, L. M., Sandow, J. J., & Ekert, P. G. (2015). The molecular relationships between apoptosis, autophagy and necroptosis. *In Seminars in cell & developmental biology* (Vol. 39, pp. 63-69). Academic Press.
24. LaRocca, T. J., Sosunov, S. A., Shakerley, N. L., Ten, V. S., & Ratner, A. J. (2016). Hyperglycemic conditions prime cells for RIP1-dependent necroptosis. *Journal of Biological Chemistry*, 291(26), 13753-13761.
25. Last, D., Alsop, D. C., Abduljalil, A. M., Marquis, R. P., De Bazelaire, C., Hu, K., ... & Novak, V. (2007). Global and regional effects of type 2 diabetes on brain tissue volumes and cerebral vasoreactivity. *Diabetes care*, 30(5), 1193-1199.
26. Launer, L. J. (2005). Diabetes and brain aging: epidemiologic evidence. *Current diabetes reports*, 5(1), 59-63.
27. Li, Y., Zhang, Y., Wang, L., Wang, P., Xue, Y., Li, X., ... & Li, P. (2017). Autophagy impairment mediated by S-nitrosation of ATG4B leads to neurotoxicity in response to hyperglycemia. *Autophagy*, 13(7), 1145-1160.
28. Liang, W., Chen, M., Zheng, D., He, J., Song, M., Mo, L., ... & Lan, J. (2017). A novel damage mechanism: Contribution of the interaction between necroptosis and ROS to high glucose-induced injury and inflammation in H9c2 cardiac cells. *International journal of molecular medicine*, 40(1), 201-208.
29. Liu, S., Wang, X., Li, Y., Xu, L., Yu, X., Ge, L., ... & He, S. (2014). Necroptosis mediates TNF-induced toxicity of hippocampal neurons. *BioMed research international*, 2014.
30. Liu, Y., & Levine, B. (2015). Autosis and autophagic cell death: the dark side of autophagy. *Cell Death & Differentiation*, 22(3), 367-376.
31. Ma, L. Y., Lv, Y. L., Huo, K., Liu, J., Shang, S. H., Fei, Y. L., ... & Qu, Q. M. (2017). Autophagy-lysosome dysfunction is involved in A β deposition in STZ-induced diabetic rats. *Behavioural brain research*, 320, 484-493.

32. Maiese, K., Chong, Z. Z., & Shang, Y. C. (2007). Mechanistic insights into diabetes mellitus and oxidative stress. *Current medicinal chemistry*, 14(16), 1729-1738.
33. Marasco, M. R., & Linnemann, A. K. (2018). β -Cell autophagy in diabetes pathogenesis. *Endocrinology*, 159(5), 2127-2141.
34. Muriach, M., Flores-Bellver, M., Romero, F. J., & Barcia, J. M. (2014). Diabetes and the brain: oxidative stress, inflammation, and autophagy. *Oxidative medicine and cellular longevity*, 2014.
35. Nasser, B., Zareian, P., & Alizade, H. (2020). Apelin attenuates streptozotocin-induced learning and memory impairment by modulating necroptosis signaling pathway. *International Immunopharmacology*, 84, 106546.
36. Prasad, S., Sajja, R. K., Naik, P., & Cucullo, L. (2014). Diabetes mellitus and blood-brain barrier dysfunction: an overview. *Journal of pharmacovigilance*, 2(2), 125.
37. Sadeghi, A., Hami, J., Razavi, S., Esfandiary, E., & Hejazi, Z. (2016). The effect of diabetes mellitus on apoptosis in hippocampus: cellular and molecular aspects. *International journal of preventive medicine*, 7.
38. Shi, Y., Huang, C., Zhao, Y., Cao, Q., Yi, H., Chen, X., & Pollock, C. (2020). RIPK3 blockade attenuates tubulointerstitial fibrosis in a mouse model of diabetic nephropathy. *Scientific Reports*, 10(1), 1-10.
39. Shima, T., Jesmin, S., Matsui, T., Soya, M., & Soya, H. (2018). Differential effects of type 2 diabetes on brain glycometabolism in rats: focus on glycogen and monocarboxylate transporter 2. *The Journal of Physiological Sciences*, 68(1), 69-75.
40. Soltéssová, D., Veselá, A., Mravec, B., & Herichová, I. (2013). Daily profile of glut1 and glut4 expression in tissues inside and outside the blood-brain barrier in control and streptozotocin-treated rats. *Physiological research*, 62, S115.
41. van den Oever, I. A., Raterman, H. G., Nurmohamed, M. T., & Simsek, S. (2010). Endothelial dysfunction, inflammation, and apoptosis in diabetes mellitus. *Mediators of inflammation*, 2010.

42. Vandenabeele, P., Galluzzi, L., Berghe, T. V., & Kroemer, G. (2010). Molecular mechanisms of necroptosis: an ordered cellular explosion. *Nature reviews Molecular cell biology*, *11*(10), 700-714.
43. Vanessa Fiorentino, T., Prioleta, A., Zuo, P., & Folli, F. (2013). Hyperglycemia-induced oxidative stress and its role in diabetes mellitus related cardiovascular diseases. *Current pharmaceutical design*, *19*(32), 5695-5703.
44. Volpe, C. M. O., Villar-Delfino, P. H., dos Anjos, P. M. F., & Nogueira-Machado, J. A. (2018). Cellular death, reactive oxygen species (ROS) and diabetic complications. *Cell death & disease*, *9*(2), 1-9.
45. Watada, H., & Fujitani, Y. (2015). Minireview: autophagy in pancreatic β -cells and its implication in diabetes. *Molecular Endocrinology*, *29*(3), 338-348.
46. Weber, K., Roelandt, R., Bruggeman, I., Estornes, Y., & Vandenabeele, P. (2018). Nuclear RIPK3 and MLKL contribute to cytosolic necrosome formation and necroptosis. *Communications biology*, *1*(1), 1-13.
47. Wong, R. S. (2011). Apoptosis in cancer: from pathogenesis to treatment. *Journal of Experimental & Clinical Cancer Research*, *30*(1), 87.
48. Wu, Y., Ye, L., Yuan, Y., Jiang, T., Guo, X., Wang, Z., ... & Ye, J. (2019). Autophagy activation is associated with neuroprotection in diabetes-associated cognitive decline. *Aging and disease*, *10*(6), 1233.
49. Wyss, M. T., Jolivet, R., Buck, A., Magistretti, P. J., & Weber, B. (2011). In vivo evidence for lactate as a neuronal energy source. *Journal of Neuroscience*, *31*(20), 7477-7485.
50. Yang, J. S., Lu, C. C., Kuo, S. C., Hsu, Y. M., Tsai, S. C., Chen, S. Y., ... & Lin, W. D. (2017). Autophagy and its link to type II diabetes mellitus. *Biomedicine*, *7*(2).
51. Yang, Z., & Klionsky, D. J. (2010). Mammalian autophagy: core molecular machinery and signaling regulation. *Current opinion in cell biology*, *22*(2), 124-131.
52. Yuan, Y., Chen, Y., Peng, T., Li, L., Zhu, W., Liu, F., ... & Lu, Y. (2019). Mitochondrial ROS-induced lysosomal dysfunction impairs autophagic flux and

contributes to M1 macrophage polarization in a diabetic condition. *Clinical science*, 133(15), 1759-1777.

53.Zhang, X., Xu, L., He, D., & Ling, S. (2013). Endoplasmic reticulum stress-mediated hippocampal neuron apoptosis involved in diabetic cognitive impairment. *BioMed research international*, 2013.

54.Zhou, W., & Yuan, J. (2014, November). Necroptosis in health and diseases. *In Seminars in cell & developmental biology* (Vol. 35, pp. 14-23). Academic Press.