

ISOMETRIC DRAWING AND THE STUDENT OF ARCHITECTURE

Yasser O. El-Gammal

Architectural Engineering Dept. Zakazik University

ملخص البحث الموضوع

تقدم هذه الورقة البحثية دراسة امكانية تخصيص مساحة زمنية اضافية لتدريب طلاب الفرقة الاولى لشعبة الهندسة المعمارية بكليات الهندسة علي الرسم الايزومتري الثلاثي الابعاد والاسقاط الهندسي "المعماري"

المشكلة

يجد طالب الفرقة الاولى لشعبة الهندسة المعمارية بكليات الهندسة - صعوبة في التعبير الثلاثي الابعاد عن فكرة اول مشروع له في مادة التصميم المعماري حيث جرت العادة علي ان يطلب منه رسم مسقط ثلاثي الابعاد يوضح الكتل المعمارية وفكرته التصميمية وبعض التفاصيل للمعالجات المعمارية لواجهات المبنى ما يمكن، هذا الي جانب المساقط الافقية لطوابق المبنى والواجهات وخلافه، وقد لوحظ ضعف مستوي الرسم الايزومتري الثلاثي الابعاد بصفة عامة، وذلك في الغالبية العظمي من المشاريع المعمارية لطلاب الفرقة الاولى، وبخاصة في اول تجربة لهم مع استوديو مادة التصميم المعماري، والمتمثلة في اول مشروع تصميم بالتحديد بالرغم من بساطة تكوينه ومستوي التعقيد لفكرته، الا وهو مشروع تصميم "المسكن ذو الطابق الواحد"، ولعل مرجع السبب في ذلك الي اختصار تدريس الاسقاط الهندسي "المعماري" مقارنة بالاسقاط الخاص بالرسم "الميكانيكي" اثناء الفرقة الاعدادية، او اختزاله في بعض كلييات الهندسة، والاكفاء بتدريس الاسقاط الهندسي "الميكانيكي" فقط

الهدف

تهدف هذه الورقة البحثية الي الارتقاء بمستوي التعبير المعماري الثلاثي الابعاد لطالب الفرقة الاولى لشعبة الهندسة المعمارية وخاصة في اول مشروع تصميم معماري، وذلك من خلال تخصيص مساحة زمنية اضافية لتدريب الطلاب علي الرسم الايزومتري والاسقاط الهندسي "المعماري" في السنة الاولى "ما امكن"، او في "فترة تاهيلية قبل الالتحاق بالسنة الاولى" من دراسته للعمارة، وذلك لتعويض النقص الناتج عن القصور في تدريس هذه المهارة بالسنة الاعدادية في بعض كلييات الهندسة

الطريقة والخلاصة والتوصيات

تبدأ الورقة البحثية بنبذة مختصرة وسريعة عن نشأة الرسم، مروراً بالحضارات القديمة، وذلك لتوضيح اهمية الرسم كوسيلة لترجمة وتوثيق ما يدور بخلد الانسان، ثم تقدم دراسة لقياس مستوي وجودة الرسم الهندسي المعماري الثلاثي الابعاد من خلال تحليل نماذج لاول مشاريع معمارية لطلاب الفرقة الاولى بالهندسة المعمارية مختارة بالتدرج طبقاً لمستوي التعقيد للفكرة المعمارية المقدمة، ويرجع السبب في اختيار اول مشروع تصميم بالتحديد وهو مشروع تصميم "المسكن ذو الطابق الواحد" لانه يمثل "اول تجربة" لتطبيق ما يفترض ان يكونوا قد تعلموه من مهارات الاسقاط الهندسي "المعماري" الثلاثي الابعاد خلال دراستهم بالفرقة الاعدادية، اذ لن يكون من المتاح اجراء هذه القياسات بدقة اكبر اذ ما تم دراسة نماذج لمشاريع معمارية لطلاب الفرق التي تلي الفرقة الاولى، وذلك نظراً لقلّة الاعتماد علي طرق الرسم الثلاثية الابعاد اليدوية التقليدية، وازدياد الاعتماد تدريجياً علي استخدام الحواسيب لرسم المجسمات الثلاثية الابعاد كلما تقدم الطلاب في سنوات الدراسة وحتى التخرج، ثم يتطرق البحث الي استعراض كلا من الطرق المعروفة والغير معروفة لدي المعماريين علي مستوي العالم لانواع الرسم اليدوي ذو الاسقاط المتوازي الاثلاثي الابعاد، وذلك حتي يخلص البحث الي التوصية بالتركيز علي تدريس افضل، واسهل، بل واكثر الطرق شيوعاً واستخداماً بين المعماريين في العالم

ABSTRACT

This paper discusses issues regarding learning parallel projection drawing techniques. Since first year students of architecture find some difficulty in expressing their "first design project concept" in 3Dimensional form as their "first experience with the design studio". The paper analyzes students isometric drawings based on complexity of their first design projects concepts, introduces a comparison between conventional 3Dimensional projection methods that are both; Commonly and uncommonly used by architects worldwide, and recommends facilitating a time slot either during, or before starting their first year of architecture study, in order to develop their ability to create a more convenient 3Dimensional parallel projection drawings for visualizing their design concepts

KEYWORDS : Parallel Projection Drawing Techniques, Isometric Drawing, 3Dimensional Projection

PROBLEM

Learning parallel projection drawing techniques in faculties of engineering is unfairly covered at the undergraduate level of architecture study as well as other engineering disciplines. For students enrolled in the faculty of engineering and according to the Egyptian higher education system; new students receive a general study about all engineering disciplines offered by the faculty not directed towards a specific engineering specialization or discipline during their first year program of study. Parallel projection drawing techniques are introduced only once at this first year with focus on mechanical drawings and some basic architectural drawing techniques. Also, some Egyptian faculties of engineering - removed basic architectural drawing techniques from their syllabi. This caused first year students of architecture to find difficulty in expressing their "First design project concept" in 3Dimensional form during their "First experience with the design studio".

GOAL

The goal of this research paper is to investigate the possibility of facilitating a time slot before or during the first year architecture study for developing the students' ability to create a more convenient 3Dimensional parallel projection drawing for visualizing their design concepts

METHODOLOGY

For the research paper to fulfill its goals; it firstly started with a brief overview about drawings, followed by analyzing students' isometric drawings samples based on complexity of their first projects design concepts, investigating conventional 3Dimensional parallel projection methods that are both commonly and uncommonly used by architects, and then finally introduces its recommendations

DETAILS

Overview

Since cave age; Mankind used to express his ideas, day life events, wars, victories, and contributions by drawing. Famous artists of ancient civilizations like the Pharoas, the Greeks, and the Romans wrote about laws of 3Dimensional drawings; From "Foreshortening" techniques that are developed by the pharos till the "Davinci" rules of 3Dimensional projected drawings and perspective. 3Dimensional projection is as old as the age of cave.

"Foreshortening" is a drawing technique where near objects are drawn at a larger scale, while distant objects are drawn at smaller scales, thus creating the illusion of perspective or depth. Ancient Egyptians also used foreshortening to express social differences by drawing personal figures that are at a higher social status at a larger scale, while servants and other people are drawn at smaller scales in the same drawing.

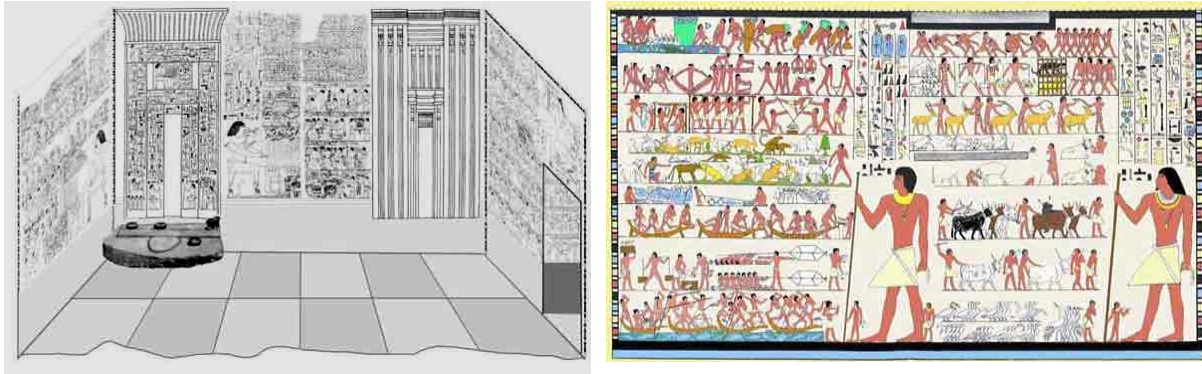

Fig. [1]: Left: '3rd Angle American' view Ptah-Hotep's chapel, Right: Color and Registers on Ptah-Hotep's chapel east wall Davies (1900, Part-1, plate XXI) and author's coloring. Both pictures show The use of foreshortening technique in ancient Egyptian art. Ref.: [1]

Analyzing Students Isometric Drawings Based On Complexity Of Their First Projects Design Concepts

The following analysis investigates quality of 3Dimensional drawings introduced by architecture freshmen in their first design project studio assignment, at their first year architecture study in Egyptian universities.

Samples Selection Criteria

- a. Selected project samples are from the design projects of the first year architecture design studio students
- b. Selected project samples are the design of a "Single story house", the first typical design studio project assignment.
- c. Project samples are selected according to level of complexity of the students design concepts, starting with: (i) Isometric drawings of design concepts with "simple straight lined geometrical forms of only cubes and rectangles, (ii) Isometric drawing of design concepts with "curved geometrical forms", (iii) Isometric drawing of design concepts with "non-uniform geometrical forms", and ending with (iv) Isometric drawing of "complex" design concepts, e.g. (parametric design concepts)

Justification of Selection Criteria

Reasons for selecting students' projects work from their first year design studio because students use hand drawing in introducing their design concepts at this year design studio only, while afterwards, they depend on computer aided drafting in creating 3Dimensional simulations of their design concepts. In addition; the reason for selecting the first design topic - which is the typical single story house design - instead of the second or third design projects assignments they have at same first year design studio", because it represents the first 3Dimensional practice of what they learned in their first general year of study

Key Note on Research Findings

Should the second or third design assignment of their first year design studio is to be selected instead; Then, findings of this study may be less accurate since the students second and third 3Dimensional isometric drawing attempts are expected to be more successful than their first ones, while the scope of this research is exploring whether the level of knowledge acquired to students in their preparatory year concerning subject matter needs to be rehearsed during and after they are enrolled in their first year architecture program

Sample Analysis

1. Students' Isometric Drawings Of "Simple Straight Lined Geometrical Forms" Design Concept: In the following design concept; Although the student used primitive "straight line" type geometrical forms such as cubes, and rectangles only for creating a traditional

design concept with a simple architectural composition, the 3Dimensional isometric drawing failed to correctly interpret architectural treatments of the facades. These differences can be easily recognized between the projected facades elevations and their corresponding expressions in the 3Dimensional sketch

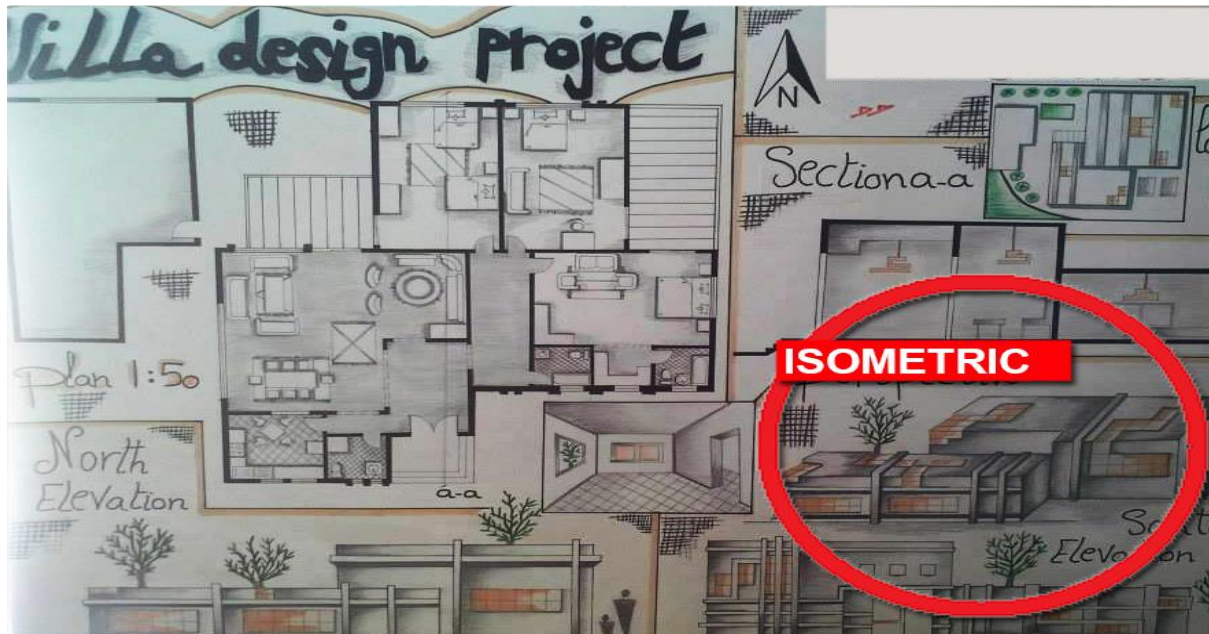

Fig. [2]: Is the students' isometric drawings of design concepts with "simple straight lined geometrical forms" of only cubes, and rectangles. Ref.: [Research]

In the following second example, the 3Dimensional isometric drawing did not correctly interpret the basic relationships between architectural forms, although the geometrical forms used in the design are primitive volumes, and not to mention also missing interpretations of the architectural facades treatments

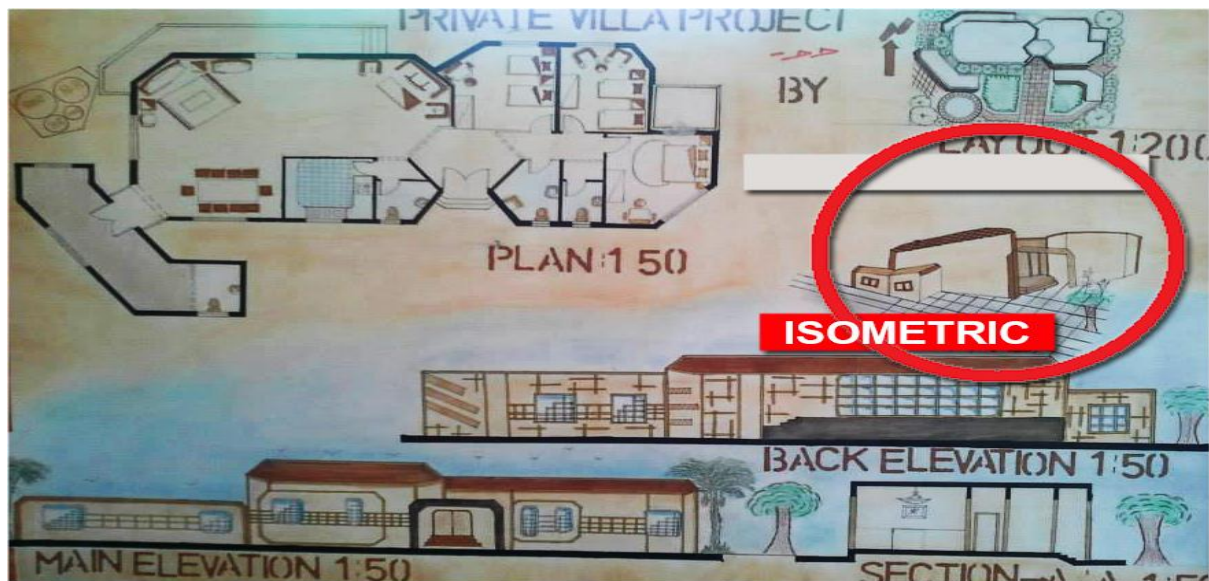

Fig. [3]: Shows a second example of a student's isometric drawing of a design concept with "Simple straight lined geometrical forms". Ref.: [Research]

2. **Students' Isometric Drawing Of "Curved Geometrical Forms" Design Concept:** In this design concept, the student used curved lines that in turn lead to forms with curved facades. The composition is still simple since the building is composed of almost two identical mirrored half elliptical geometrical volumes only, and both with regular flat roofs; This little shift due to curved lines instead of straight lines caused the student to experience difficulty in simulating the concept in 3Dimensional isometric mode, as clearly shown in the figure below

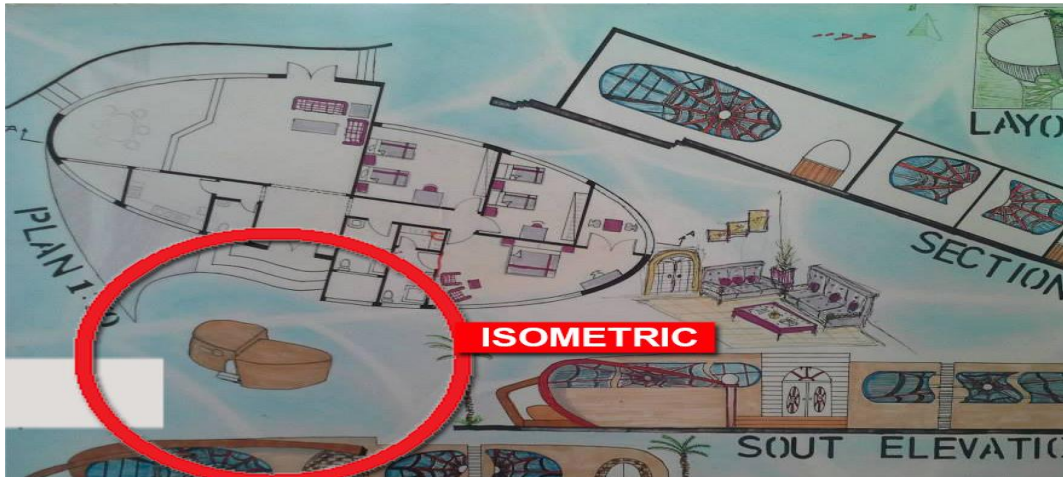

Fig. [4]: Shows a students' isometric drawing of design concepts With "curved geometrical forms". Ref.: [Research]

3. **Students' Isometric Drawing Of "Non-Uniform Geometrical Forms" Design Concept:** In the following two examples, design lines are non-uniform in plans, sections, elevations, and facade treatments. Discrepancies in design can be traced between each; including the simulated 3Dimensional drawing

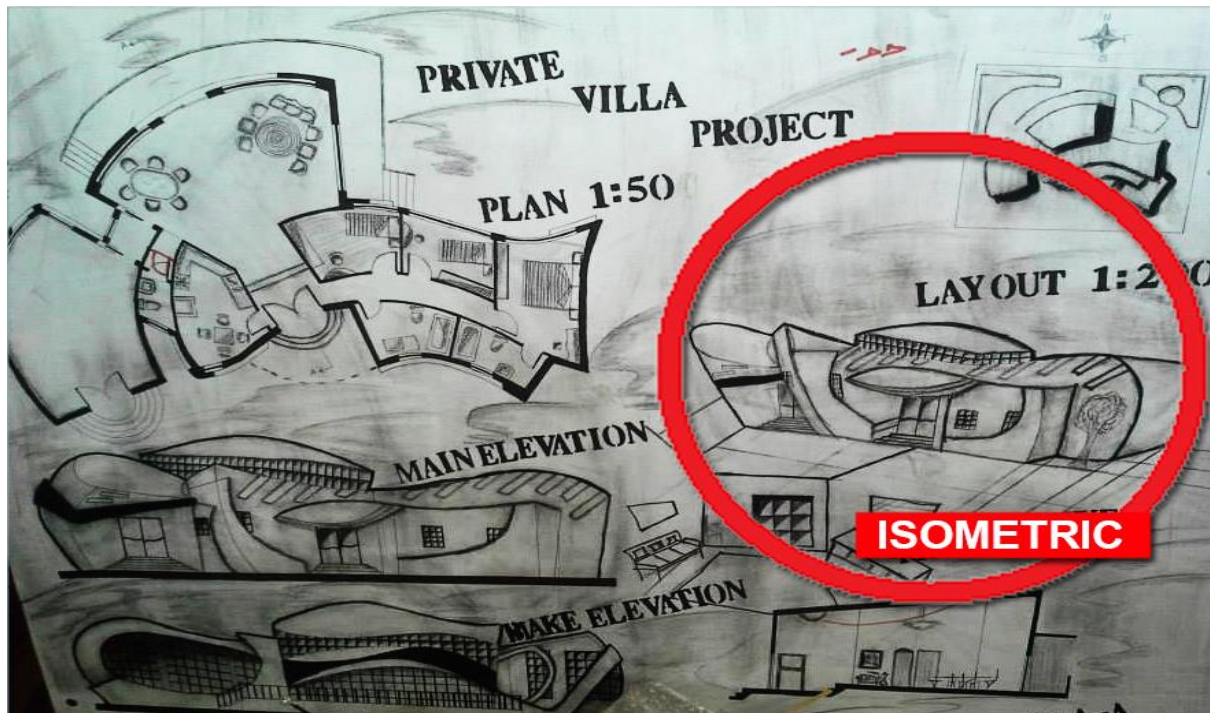

Fig. [5]: Shows a students' isometric drawing of "non-uniform geometrical forms"

Design concept. Ref.: [Research]



Fig. [6]: Shows another example of a students' isometric drawing of a design concept with "non-Uniform geometrical forms". Ref.: [Research]

4. **Students' Isometric Drawing Of more Complex (Parametric Design Concept):** As the design gets more complex, In this example; the concept implements a parametric like or a dome/egg like-shell volumes. Although the student's overall quality of the project visualization is appealing; 3Dimensional isometric simulation of the design concept didn't clearly reflect the interrelated connections between these egg like shell structures, with the same quality and level of details as it is vividly expressed in the facades projected drawings



Fig. [7]: Shows students' isometric drawing of a complex parametric-like concept. Ref.: [Research]

Conventional 3Dimensional Parallel Projection Methods That Are Commonly Used By Architects Worldwide

1. Orthographic or Orthogonal Projection: Represents 2Dimensional objects in 3Dimensional mode by parallel projections, so that all lines projected on the 3Dimensional plane have real measurements equivalent to that in nature. Orthographic or orthogonal projection, sometimes called parallel projection; is the projection type of choice for architectural working drawings^{1 2 3}

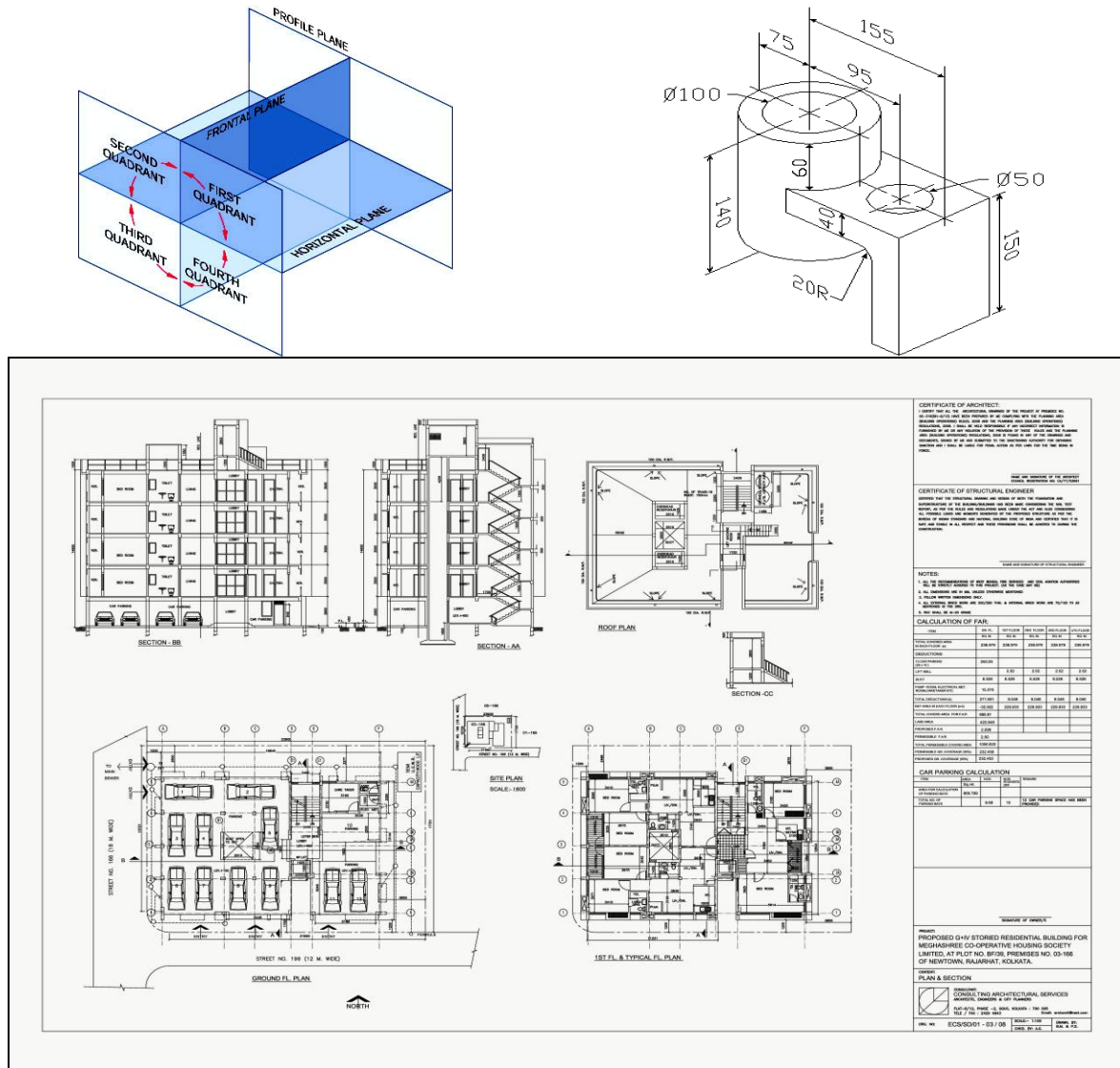

Fig. [8]: Left: shows the general concept of orthogonal 3Dimensional projection. Right: shows an example of 3Dimensional isometric projection commonly used in mechanical engineering drawings. Below: shows

¹ Schaum's Outline: "Descriptive Geometry", McGraw-Hill publishing, (June 1, 1962), ISBN 978-0070272903

² "Working Drawing sample. IT building Kolkata" By: Sunayan Sarkar in architectural working drawing, published Saturday 7, 2015. Consulting Architectural Design Services - Creative Designing in Architecture to help people meet their demand and moving towards building a better community. Source: <https://consultingarchitecturaldesignservices.wordpress.com/tag/architectural-working-drawing/>

³ "Planar Geometric Projections and Viewing Transformations". ACM Computing Surveys. By: Ingrid Carlbom; Joseph Paciorek; Dan Lim (December 1978). ACM. 10 (4): 465–502. doi:10.1145/356744.356750

a "Working drawing sample of an IT building in Kolkata" as an example of parallel projection commonly used in architectural construction drawings. Ref: [2], [3]

2. **Isometric 3Dimensional Projection**: The term "Isometric" comes from the Greek word: "Equal Measure", so that the scale along each axis of the projection is a real dimension equal to that in nature. Unlike perspective drawings where all dimensioned are "Foreshortened" towards imaginary vanishing points. Isometric projection is commonly used in mechanical engineering design, while in some cases; it is also used in architectural drawing.^{4,5}
3. **Axonometric 3Dimensional Projection**: Is a type of 3Dimensional projection used for creating a pictorial drawing of an object, the later is rotated around its axes creating a scene revealing 3Dimensional slices of the object. Axonometric projection is commonly used by architects in America and Europe, this projection technique is useful in decomposing multistoried building parts in architectural presentations, it is rarely used by architects in Egypt and the Middle East.^{6,7,8}

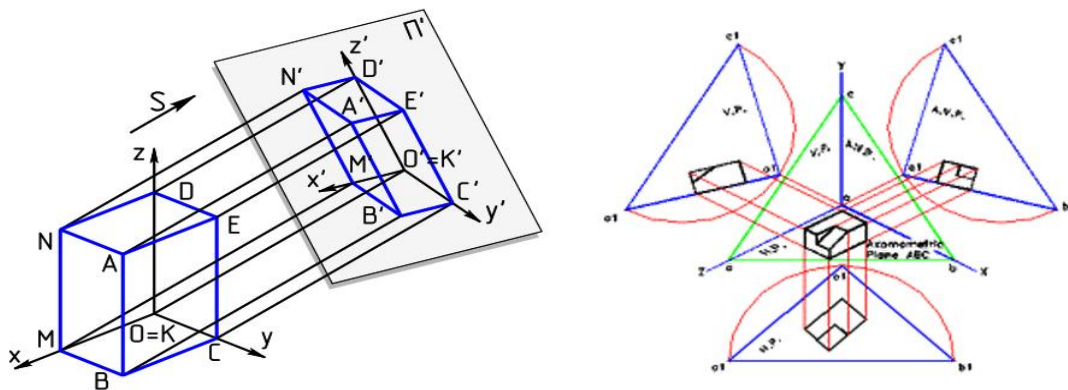

Fig. [9]: Shows examples of 3Dimensional axonometric projection
Commonly used in engineering drawings. Ref: [7], [8]

⁴ "True Ellipses in Isometric", By: Kean at: aidankeane@tinet.ie. Source: <https://www3.ul.ie/~rynet/keanea/iso2.htm>

⁵ "Orthographic Projection", An attempt for helping Junior Cert and College students to understand orthographic projection. As a part of the final year project for the University of Limerick (<https://www.ul.ie/>). By: Steven Colgan email: Steven.colgan@gmail.com, Source: http://www3.ul.ie/~rynet/orthographic_projection_fyp/webpages/third_angle.html

⁶ "Engineering Graphics-Graphics for Engineers" By: Giesecke, O'Bryant, Dobrovolny, et al, Macmillan Publishers, Stipes Publishing Co. ISBN 0-12-946326-2, ISBN 0-87563-361-7, Also may be accessed at: http://test.scoilnet.ie/Res/paulmcdonnell130899015624_2.htm

⁷ "Technical Graphics Communication" Gary R. Bertoline et al. (2002). McGraw-Hill Professional, 2002. ISBN 0-07-365598-8, p. 330

⁸ "Best 25+ Axonometric drawing ideas on Pinterest | Architecture". PUJADES 279 (Barcelona) - DRST DRAWING. Architecture Drawing Plan Architecture Panel Axonometric. Source: <https://www.pinterest.com/explore/axonometric-drawing/>

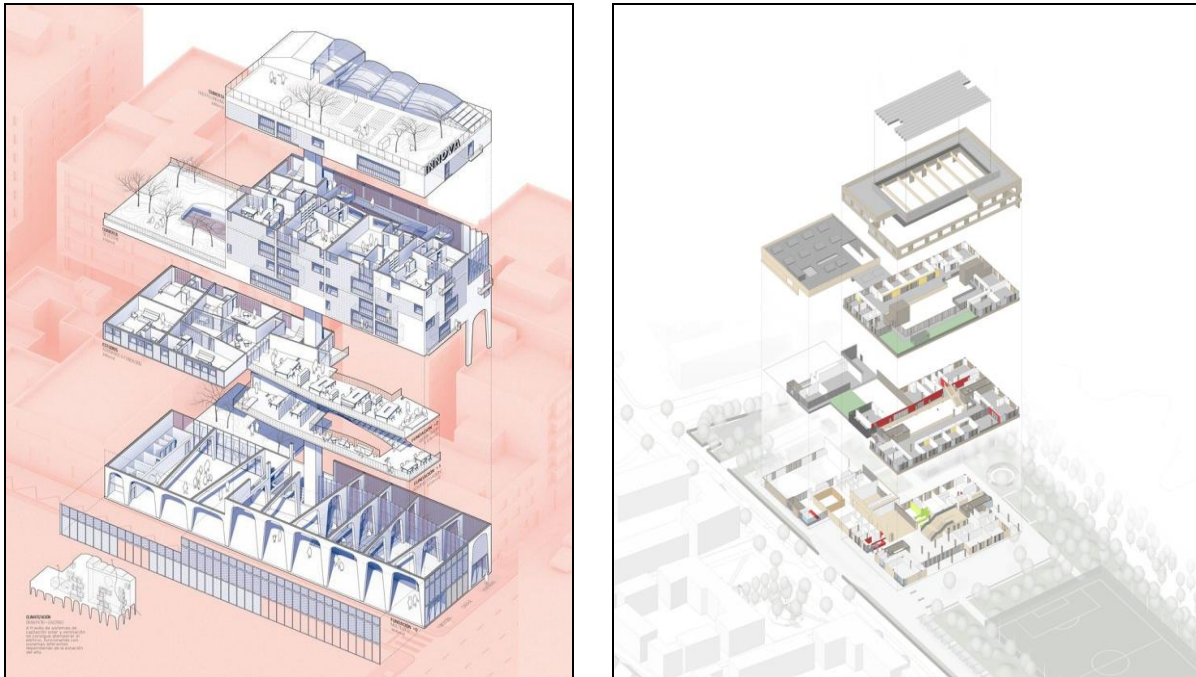

Fig. [10]: Shows examples of 3Dimensional Architectural Axonometric projection Commonly used by American and European architects. Ref: [9]

4. **Oblique 3Dimensional Projection:** Is an isometric 3Dimensional projection type where lines are projected in an inclination of 45° from the eye of the observer. The technique produces convincing and useful images, and it is sometimes used by architects.^{9 ' 10 ' 11}

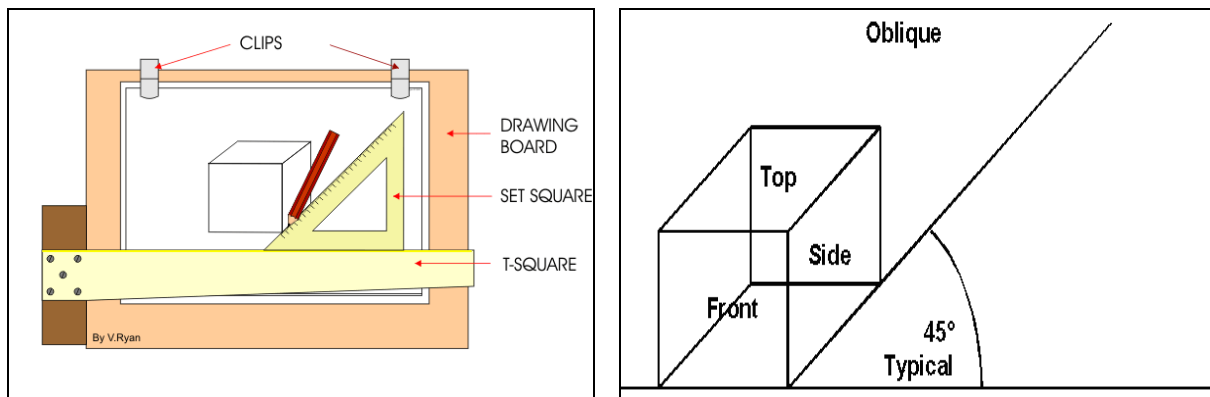

Fig. [11]: Shows examples of 3Dimensional oblique projection techniques that are sometimes used by architects. Ref: [10], [11]

Other 3Dimensional Projection Types That Are Not Commonly Used By Architects

5. **Stereographic 3Dimensional Projection:** Is particularly a mapping function that projects a spherical surface into a flat plane. Similarly, this type of projection is the origin of computer graphics and 3Dimensional computer rendering Architects are not familiar

⁹ "OBLIQUE PROJECTION", By: V. Ryan © 2006 - 2008, Source: <http://www.technologystudent.com/despro2/obli1.htm>

¹⁰ "OBLIQUE PROJECTION", Wikipedia, Source: https://en.wikipedia.org/wiki/Oblique_projection

¹¹ "Isometric & Oblique Pictorials" A Hinsdale Township High School District, By: Matthew Gawlik for the students of Hinsdale South High School, Published: Wednesday April08/2009, Source: http://hinsdale86.org/staff/mgawlik/pre-eng1/Projects/Oblique_Pictorial.htm

with this type of projection, and they almost do not use it in any of their drawing tasks except in computer graphics applications.^{12 ' 13 ' 14 ' 15}

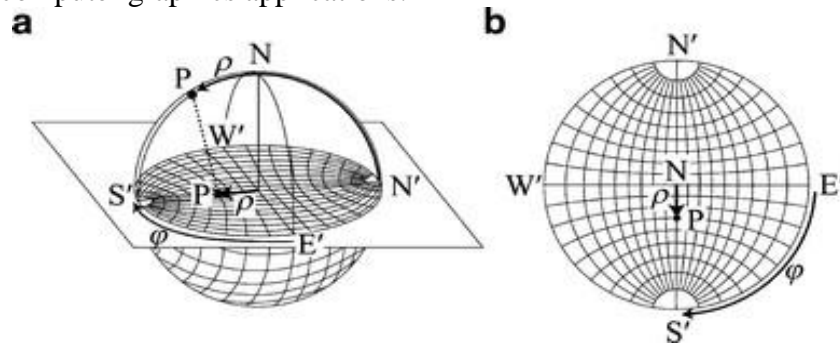

Fig. [12]: Shows a schematic explaining Stereographic 3D Dimensional Projection. Ref: [13]

6. **Cavalier Projection:** Is another form of oblique projection. The only difference between the two is that in cavalier projection; the plane of projection is parallel to either the left or right sides of the object and not facing the front side of such object as in the case of oblique projection. Architects are not familiar with this projecting technique.¹⁶

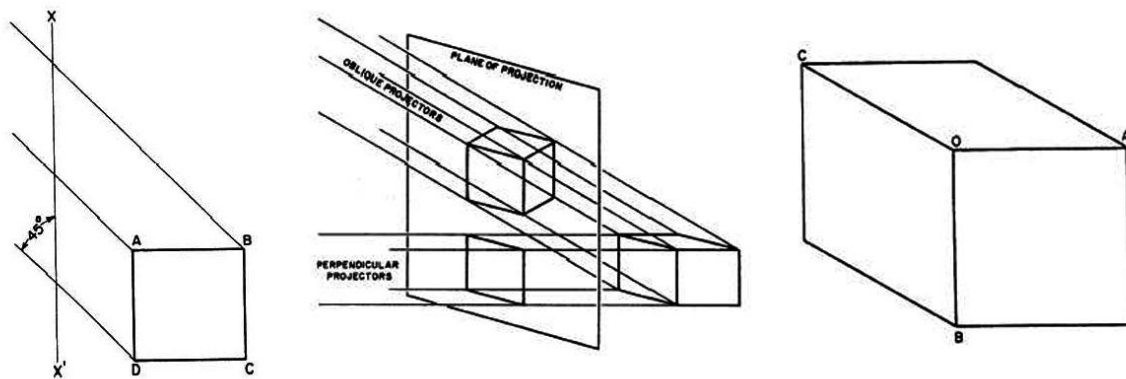

Fig. [13]: Shows a schematic explaining Cavalier Projection. Ref: [17]

7. **Cabinet Projection:** Is also another type of oblique projection. The term "Cabinet projection" comes out from its use in illustrating furniture, kitchen cabinet design, and woodwork in general. It is also used in "Military projection" of city maps, and strategy computer games graphics like for example the famous "Sim City", and "Civilization" Strategy computer games. This projecting technique is rarely used by architects^{17 ' 18 ' 19}

¹² "Stereographic projection", By: henryseg, published Dec 13/2013, Source: <https://www.thingiverse.com/thing:202774>

¹³ "Stereographic projection" Wikipedia, Source: https://en.wikipedia.org/wiki/Stereographic_projection

¹⁴ "Use of the Wulff net in constructing a stereogram", University of Cambridge DoITPoMSTLP Library, The stereographic projection, "Use of the Wulff net in constructing a stereogram", Source: https://www.doitpoms.ac.uk/tlplib/stereographic/wulff_construct.php

¹⁵ "Projection of the grid net of globe for producing the Wulff net", Research gate, Source: https://www.researchgate.net/figure/278712327_fig45_Figure-47-Projection-of-the-grid-net-of-globe-for-producing-the-Wulff-net

¹⁶ "Oblique Drawing Techniques" - Engineering Aid 3 - Beginning Structural engineering guide book, The Harvard Extension school, Publisher: Integrated publishing TPUB.com, Source: <http://engineeringtraining.tpub.com/14069/css/Cavalier-Projection-177.htm>

¹⁷ "Cabinet projection", Webster Dictionary, Source: <https://www.merriam-webster.com/dictionary/cabinet%20projection>

¹⁸ "Design Drawing (2nd ed.)", By: Ching, Francis D. K., Juroszek, and Steven P. (2011), publisher: John Wiley & Sons, p. 205, ISBN 9781118007372

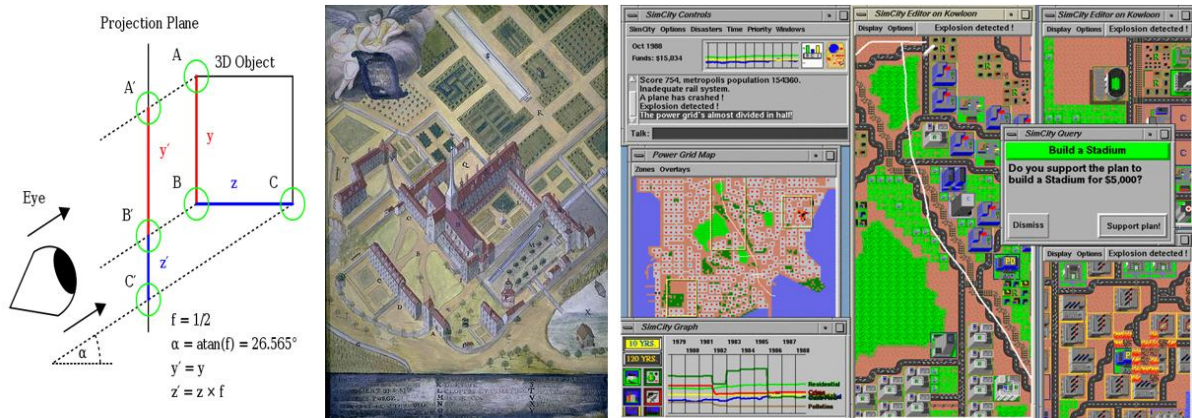

Fig. [14]: Shows a schematic explaining Cabinet Projection, Left: A cabinet projection of a cube with foreshortening by half, seen from the side, Middle: (18th) century plan of Port-Royal-des-Champs drawn in military projection, Right: A simulation of a military projection Used in the video game (SimCity). Ref: [18], [19], [20]

8. Dimetric Projection: Is a way of drawing an object so that one axis has a different scale than the other two axis in the drawing. An example of Dimetric projection is a technical drawing that shows a 3Dimensional cube with one side of the cube smaller in proportion to the other two sides. This projecting technique is rarely used by architects as a hand drawing technique, However, some 3Dimensional software applications like: 3Dmax by Autodesk implement this technique inside its three dimensional environment when activating its "Orbit" mode.^{20, 21}

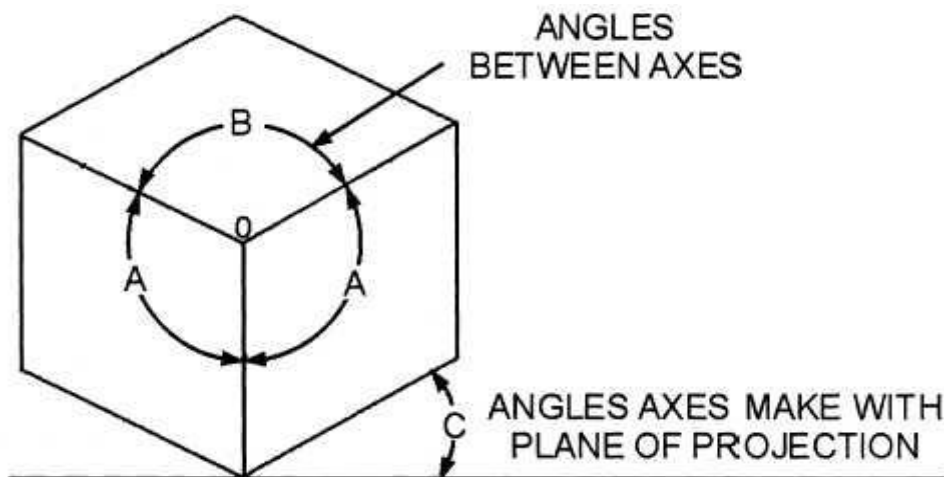

Fig. [15]: Shows a schematic explaining diametric projection concept. Ref: [21]

¹⁹ "The Geometry of Perspective Drawing on the Computer", published: 24 April 2015, Source: <https://www.compuphase.com/axometr.htm>

²⁰ "Dimetric projection", Your Dictionary.com, Source: <http://www.yourdictionary.com/dimetric-projection>

²¹ "Dimetric projections" - Orthographic Projections Continued, Integrated Publishing, TPUB.com, Source: <http://draftingmanuals.tpub.com/14276/css/Dimetric-Projections-326.htm>

9. Trimetric Projection: Is a geometrical projection used in mechanical drawing, where the three triangle axes are at arbitrary angles. Architects are not familiar with this type of projection^{22, 23}

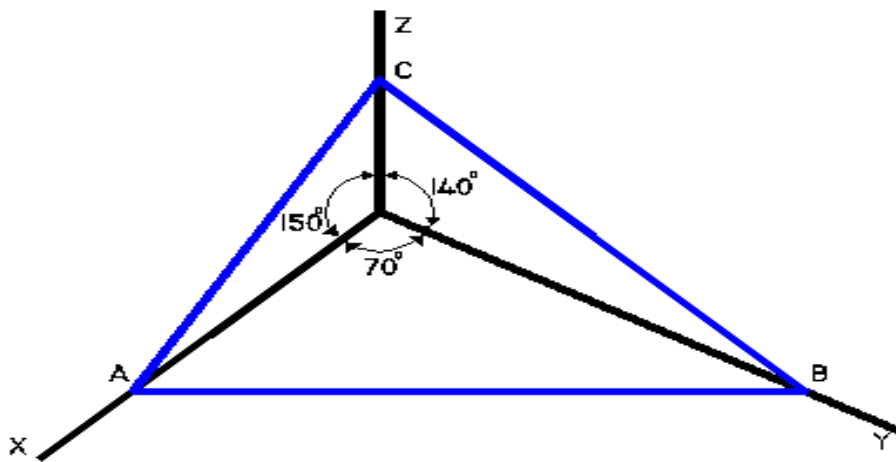

Fig. [16]: Shows a schematic explaining Trimetric projection concept. Ref: [23]

CONCLUSION

- Learning parallel projection drawing techniques in Egyptian faculties of engineering is unfairly covered at the undergraduate level of architecture study as well as other engineering disciplines.
- Parallel projection drawing techniques are introduced only once at this first year with focus on mechanical drawings and some basic architectural drawing techniques.
- Even basic architectural drawing techniques that used to exist in the first year program are now - in some Egyptian faculties of engineering - removed from their syllabi.
- First year students of architecture find difficulty in expressing their "First design project concept" in 3Dimensional form during their "First experience with the design studio".
- Although there are many conventional 3Dimensional parallel projection methods that are commonly used by architects worldwide, architects are not familiar with other 3Dimensional projection types like; Stereographic, cavalier, cabinet, dimetric, and trimetric projections

RECOMMENDATIONS

- It is recommended to Facilitate a time slot before, or during the first year architecture study for developing the students' ability to create a more convenient 3Dimensional parallel projection drawings for visualizing their design concepts
- Teaching and practicing hand drawing techniques of both isometric and axonometric projections in architectural course maps.
- With focusing on training architecture students on using axonometric projection in particular. Since this type of projection is widely used by architects in USA, Canada, and Europe, this intention is for the purpose of increasing the mobility of Egyptian architects around the globe

²² "Trimetric projection" Dictionary.Com, Source: <http://www.dictionary.com/browse/trimetric-projection>

²³ "Trimetric Projection", University of Limerick, Source: <https://www3.ul.ie/~rynnnet/keanea/trimetri.htm>

REFERENCES

1. "Perceptual and Conceptual Art in Ancient Egypt", Egyptology and Archaeology through Images: Published: November 02/2017, Source: <http://www.ancient-egypt.co.uk/people/the-art.htm>, retrieved: February 2018
2. Schaum's Outline: "*Descriptive Geometry*", McGraw-Hill publishing, (June 1, 1962), ISBN 978-0070272903, retrieved September 2017
3. "Working Drawing sample. IT building Kolkata" By: Sunayan Sarkar in architectural working drawing, published Saturday 7, 2015. Consulting Architectural Design Services - Creative Designing in Architecture to help people meet their demand and moving towards building a better community. Source: <https://consultingarchitecturaldesignservices.wordpress.com/tag/architectural-working-drawing/>, retrieved September 2017
4. "Planar Geometric Projections and Viewing Transformations". ACM Computing Surveys. By: Ingrid Carlbom; Joseph Paciorek; Dan Lim (December 1978). ACM. 10 (4): 465–502. doi:10.1145/356744.356750, retrieved August 2017
5. "True Ellipses in Isometric", By: Kean at: aidankeane@tinet.ie. Source: <https://www3.ul.ie/~rynet/keane/iso2.htm>, retrieved September 2017
6. "Orthographic Projection", An attempt for helping Junior Cert and College students to understand orthographic projection. As a part of the final year project for the University of Limerick (<https://www.ul.ie/>). By: Steven Colgan email: Steven.colgan@gmail.com, Source: http://www3.ul.ie/~rynet/orthographic_projection_fyp/webpages/third_angle.html, retrieved September 2017
7. "Engineering Graphics-Graphics for Engineers" By: Giesecke, O'Bryant, Dobrovolny, et al, Macmillan Publishers, Stipes Publishing Co. ISBN 0-12-946326-2, ISBN 0-87563-361-7, Also may be accessed at: http://test.scoilnet.ie/Res/paulmcdonnell130899015624_2.htm, retrieved September 2017
8. "Technical Graphics Communication" Gary R. Bertoline et al. (2002). McGraw-Hill Professional, 2002. ISBN 0-07-365598-8, p. 330, retrieved: August 2017
9. "Best 25+ Axonometric drawing ideas on Pinterest | Architecture". PUJADES 279 (Barcelona) - DRST DRAWING. Architecture Drawing Plan Architecture Panel Axonometric. Source: <https://www.pinterest.com/explore/axonometric-drawing/>, retrieved September 2017
10. "OBLIQUE PROJECTION", By: V. Ryan © 2006 - 2008, Source: <http://www.technologystudent.com/despro2/obli1.htm>, retrieved September 2017
11. "OBLIQUE PROJECTION", Wikipedia, Source: https://en.wikipedia.org/wiki/Oblique_projection, retrieved September 2017
12. "Isometric & Oblique Pictorials" A Hinsdale Township High School District, By: Matthew Gawlik for the students of Hinsdale South High School, Published: Wednesday April 08/2009, Source: http://hinsdale86.org/staff/mgawlik/pre-eng1/Projects/Oblique_Pictorial.htm, retrieved September 2017
13. "Stereographic projection", By: henryseg, published Dec 13/2013, Source: <https://www.thingiverse.com/thing:202774>, retrieved September 2017
14. "Stereographic projection" Wikipedia, Source: https://en.wikipedia.org/wiki/Stereographic_projection, retrieved September 2017
15. "Use of the Wulff net in constructing a stereogram", University of Cambridge DoITPoMSTLP Library, The stereographic projection, "Use of the Wulff net in constructing a stereogram", Source: https://www.doitpoms.ac.uk/tlplib/stereographic/wulff_construct.php, retrieved September 2017

- "Projection of the grid net of globe for producing the Wulff net", Research gate, Source: https://www.researchgate.net/figure/278712327_fig45_Figure-47-Projection-of-the-grid-net-of-globe-for-producing-the-Wulff-net, retrieved September 2017
16. "Oblique Drawing Techniques" - Engineering Aid 3 - Beginning Structural engineering guide book, The Harvard Extension school, Publisher: Integrated publishing TPUB.com, Source: <http://engineeringtraining.tpub.com/14069/css/Cavalier-Projection-177.htm>, retrieved September 2017
 17. "Cabinet projection", Webster Dictionary, Source: <https://www.merriam-webster.com/dictionary/cabinet%20projection>, retrieved: August 2017
 18. " Design Drawing (2nd ed.)", By: Ching, Francis D. K., Juroszek, and Steven P. (2011), publisher: John Wiley & Sons, p. 205, ISBN 9781118007372, retrieved September 2017
 19. "The Geometry of Perspective Drawing on the Computer", published: 24 April 2015, Source: <https://www.compuphase.com/axometr.htm>, retrieved September 2017
 20. "Dimetric projection", Your Dictionary.com, Source: <http://www.yourdictionary.com/dimetric-projection>, retrieved September 2017
 21. "Dimetricprojections" - Orthographic Projections Continued, Integrated Publishing, TPUB.com, Source: <http://draftingmanuals.tpub.com/14276/css/Dimetric-Projections-326.htm>, retrieved September 2017
 22. "Trimetric projection" Dictionary.Com, Source: <http://www.dictionary.com/browse/trimetric-projection>, retrieved September 2017
 23. "Trimetric Projection", University of Limerick, Source: <https://www3.ul.ie/~rynnnet/keanea/trimetri.htm>, retrieved September 2017

FURTHER READINGS

- Subhashis Banerjee (2002-02-18). "The Weak-Perspective Camera".
- Alter, T. D. (July 1992). 3D Pose from 3 Corresponding Points under Weak-Perspective Projection (PDF) (Technical report). MIT AI Lab.
- Ingrid Carlbom, Joseph Paciorek (1978). "Planar Geometric Projections and Viewing Transformations" (PDF). ACM Computing Surveys. 10 (4): 465–502. doi:10.1145/356744.356750.
- Riley, K F (2006). Mathematical Methods for Physics and Engineering. Cambridge University Press. pp. 931, 942. ISBN 0-521-67971-0. doi:10.2277/0521679710.
- Goldstein, Herbert (1980). Classical Mechanics (2nd ed.). Reading, Mass.: Addison-Wesley Pub. Co. pp. 146–148. ISBN 0-201-02918-9.
- Sonka, M; Hlavac, V; Boyle, R (1995). Image Processing, Analysis & Machine Vision (2nd ed.). Chapman and Hall. p. 14. ISBN 0-412-45570-6.