



Comparison between the Structurally Controlled Radioactive Minerals at Felsic Granites of G. Abu Harba, G. Dara and G. Hamrat Al Jirjab Areas, Northern Eastern Desert, Egypt

Anton G. Waheeb and Joseph M. Samaan

Nuclear Materials Authority from Cairo, Egypt. P.O.Box 530; El-Maadi, Kattamyia, Cairo, Egypt

FELSIC granites of G.Abu Harba, G.Dara and G. Hamrat Al Jirjab areas are characterized by the presence of radioactive shear zones.

The radioactive minerals occurrence at G.Abu Harba area and G. Dara area are recorded along normal fault zone or shear zone trending in the same direction (N15°W) with same dips of about 86°. The gamma radioactivity measured over these anomalies ranges between 1800 ppm to 2400 ppm; while the occurrence of the radioactive mineral at G. Hamrat Al Jirjab is along sinistral strike slip fault trending N50°W with a dip equal 70° to NE. The gamma radioactivity reaches 2200 ppm.

shear stress required initiating slip on both G. Abu Harba and G. Dara radioactive shear zones is directed in the same trend(N-S) direction; while G.Hamrat Al Jirjab radioactive shear zone is directed NNW-SSE direction. The shear strain on both G. Abu Harba and G. Dara mineralized shear zones is also the same (pitches by 87° and 82° respectively the same direction E); while G.Hamrat Al Jirjab mineralized shear zone pitches by different amount equal 42° to W.

The mineralogical study revealed that the uranium minerals are the main detected radioactive minerals at G.Dara and G. Abu Harba areas while the thorium minerals are the main detected radioactive minerals at G. Hamrat Al Jirjab area.

Keywords: Shear stress, Shear strain, Radioactive minerals, Granits of G. Dara, G.Abu Harba and G. Hamrat Al Jirjab areas.

Introduction

The granitic rocks of the investigated areas are located at the northern eastern desert above latitude 27°14' N, where; the Gabal(G.)Dara granite is bounded by latitude 27° 55' to 28° 00' N and longitudes 32° 55' and 33° 00' E, G.Hamrat Al Jirjab granite is bounded by latitudes 27° 44' and 27° 47' N and longitudes 33° 17' and 33° 20' E and G. Abu Harba granite is bounded by latitude 27° 14' N to 27° 18' N and longitude 33° 11' E to 33° 13' E(Fig.1).

The granitic rocks represent 40% of the exposed basement rocks in the Eastern Desert of Egypt(Rogers, 1978), from which about 13% are younger granites. The Neoproterozoic Egyptian basement rocks are subdivided into three domains: northern (NED), central (CED) and southern (SED). These domains can be distinguished by their contrasting structural features (Fig.2).

The southern domain is essentially characterized by compressional deformation (Greiling *et al.*, 1994) and there is no direct structural evidence of extension.

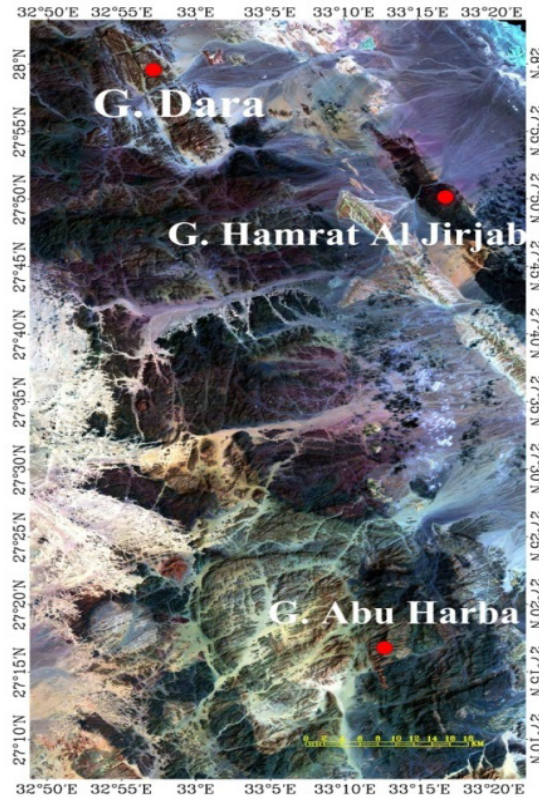

Fig. 1. Land sat image for G. Dara, G. Hamrat Al Jirjab and G. Abu Harba granites, Northern Eastern Desert, Egypt.

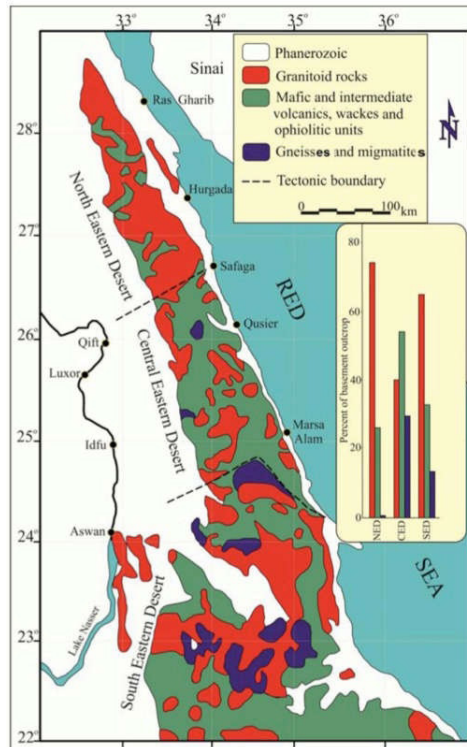

Fig.2. Simplified geological map of the Neoproterozoic basement exposed in the Eastern Desert of Egypt. Inset shows the relative abundance in the 3 major basement provinces of the Eastern Desert of Egypt [Stern and Hedge, 1985].

On the other hand, the northern domain is characterized by abundant extensional structures which are overprinted by both reverse and strike-slip faulting (Bennett and Mosley, 1987).

The famous uranium occurrence in Egypt are found in the Neoproterozoic late Pan African felsic granites of the Arabian-Nubian shield that formed when an extensional tectonic style occurred at 620–600My ago (Kröner et al., 1987 and Genna et al., 2002); Such as, G. Dara (Shalaby 1985), G. Abu Harba (Roz, 2001), G.Hamrat Al Jirjab (El Kholly, 1995). The above mentioned uranium occurrences are structurally controlled by shear zones (El-Mansi et al., 2004, Salman et al., 1995, El Sundoly 2021, Waheeb 2016 and El Sundoly and Waheeb. 2021). The granites of G. Abu Harba are high-K metaluminous to slightly peraluminous granites (Rashwan et al., 2013); The Dara granitic rocks range in composition from granite to quartz monzonite originated from calc-alkaline to alkaline, metaluminous to peraluminous magma type that developed in an extensional environment in a volcanic arc (I-type) (El-Desoky and Hafez, 2018) and The granites of G. Hamrat Al Jirjab area are alkali feldspar granite (Abdel Hadi, 2013). These types of granites are detected as the main source for uranium deposits (Cuney, 2009).

The present paper elucidates the direction of shear stress and strain and mineralogy of structurally controlled uranium occurrences at alkali feldspar granites of Gabal Abu Harba, Gabal Dara and Gabal Hamrat Al Jirjab areas to detect and compare between the direction of shear stress required initiating slip, the direction of shear strain and minerals constitute on these areas at North Eastern Desert of Egypt.

Structure control mineralization

The uranium occurrence at G.Abu Harba area is recorded along a mylonitic normal fault zone or shear zone trending N15°W with dips of about 86° to SW (Fig. 3). The gamma radioactivity measured over this anomaly reaches 1800 ppm .as well as, the uranium at G.Dara area is detected along normal fault zone or shear zone is striking N15°W and the dip is 85° to NE (Fig.4) The gamma radioactivity measured along this fault zone ranging between 2350 to 2400 ppm; while the uranium occurrence at G.Hamrat Al Jirjab area is along sinistral strike slip fault trending N50°W with dip equal 70° to NE (Fig.5) The gamma radioactivity reaches to 2200 ppm.



Fig. 3. Mineralized mylonitic normal N15°W shear zone dipping 86° to SW in Abu Harba granites with visible oval secondary uranium mineral, top view, G. Abu Harba area.



Fig.4. Mineralized N15 ° W fault zone and the dip is 85° to NE, top view, G. Dara area.

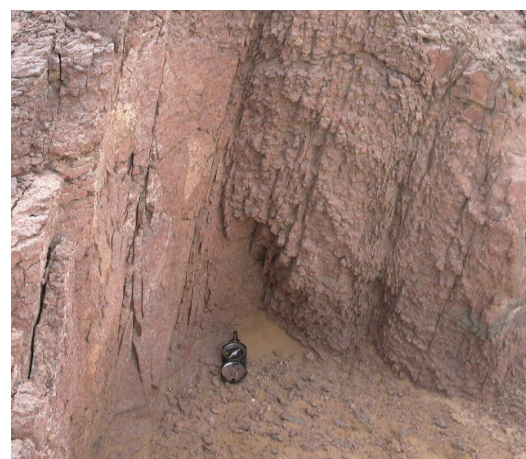

Fig.5. Mineralized N50 ° W sinistral fault plane with dips equal 70° to NE, Looking NW, G. Hamrat Al Jirjab area.

Methodology

For the mineralized shear zones in granites of G. Abu Harba, G. Dara and G. Hamrat Al Jirjab, a graphical technique (Lisle, 1998) was employed to estimate the direction of shear stress and shear strain. The orientations of the three main stress axes, as well as the stress ratio, are required for this graphical method. These data are obtained by using the pressure/ tension paleostress fault analysis method (Delvaux and Sperner 2003) for shear zone fault planes.

Selected samples from the studied areas were chosen based on their high radioactivity level for heavy minerals separation. The samples were crushed, powdered, and sieved before being exposed to heavy mineral separation using bromoform (sp. gr. = 2.85 gm/cm³), washed, dried and pure mineral grains were hand-picked to the heavy minerals from the resultant heavy fractions. The separated heavy minerals were examined by Environmental Scanning Electron Microscope (ESEM), by using a backscatter detector (BSE). A Philips XL 30 energy-dispersive X-ray (EDAX) unit is included in this instrument. The analytical settings used were a 30 kV accelerating voltage and the investigations were performed at Egypt's Nuclear Materials Authority (NMA).

Results

Shear Stress (τ) and Shear Strain (γ)

At G. Abu Harba area, the principle stress σ_1 plunges 56° on bearing 111°, σ_2 plunges 23° on bearing 342° and σ_3 plunges 23° on bearing 242° respectively. The stress ratio is 0.5 (Fig.6); while at G. Dara area, the principle stress σ_1 plunges 53° on bearing 250°, σ_2 plunges 2° on bearing 343° and σ_3 plunges 36° on bearing 75° respectively. The stress ratio is 1 (Fig.7). Finally, in G. Hamrat Al Jirjab area, the principle stress σ_1 plunges 21° on bearing 286°, σ_2 plunges 67° on bearing 76° and σ_3 plunges 11° on bearing 190° respectively. The stress ratio is 0.5 (Fig.8).

At G. Abu Harba uranium occurrence, the direction of shear stress (τ) plunges 63° on bearing 178° (N-S) (Fig.9) and the shear strain (γ) pitches 87° E (Fig.10), as well as, at G. Dara uranium occurrence, the direction of shear stress (τ) plunges 84° on bearing 10° (N-S)(Fig.11) and the shear strain (γ) pitches 82° E (Fig.12) but at G. Hamrat Al Jirjab uranium occurrence, the direction of shear stress (τ) plunges 0° on bearing 327° (NNW-SSE) (Fig.13) and the shear strain (γ) pitches 42° W (Fig.14).

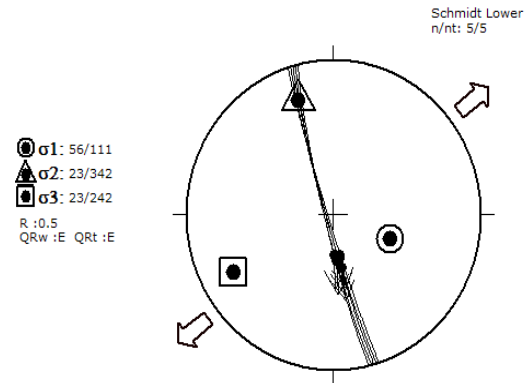

Fig. 6. The three stress axes for the mineralized shear zone at G. Abu Harba area.

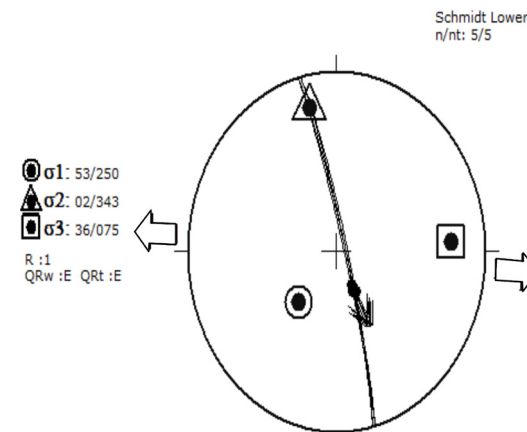

Fig. 7. The three stress axes for the mineralized shear zone at G. Dara area.

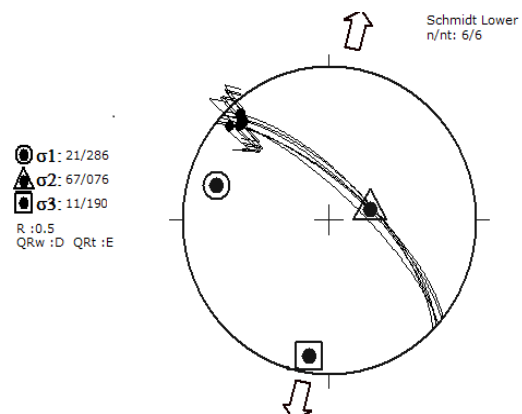

Fig. 8. The three stress axes for the mineralized shear zone at G. Hamrat Al Jirjab area.

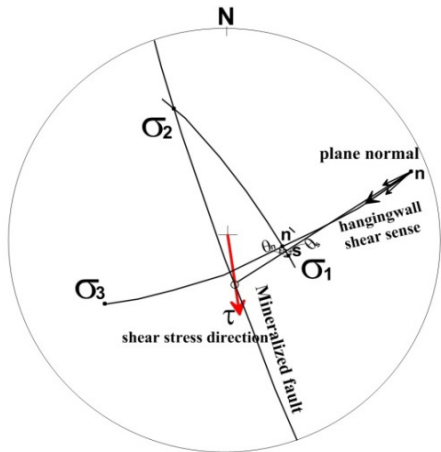

Fig. 9. Stereographic construction for the direction of shear (τ) of the mineralized shear zone at G. Abu Harba area.

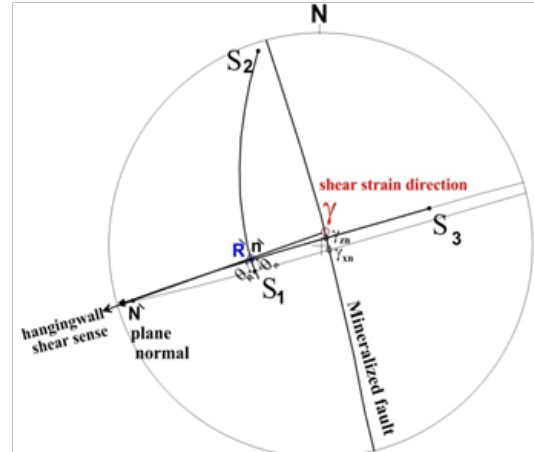

Fig. 12. Stereographic construction for the direction of strain (γ) of the mineralized shear zone at G. Dara area.

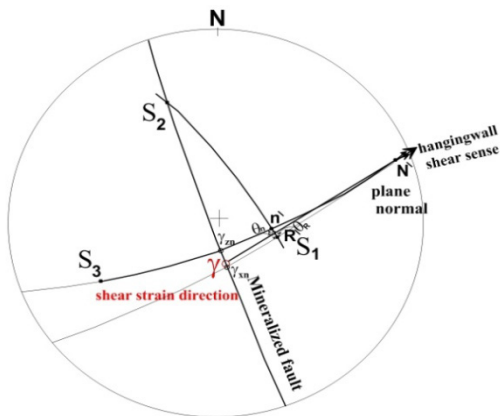

Fig. 10. Stereographic construction for the direction of strain (γ) of the mineralized shear zone at G. Abu Harba area.

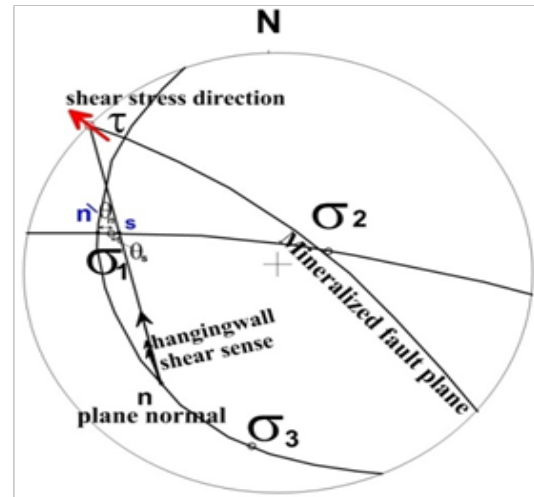

Fig. 13. Stereographic construction for the direction of shear (τ) of the mineralized shear zone at G. Hamrat Al Jirjab area.

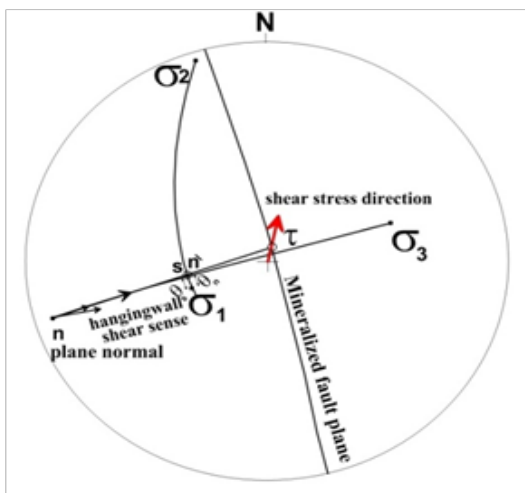

Fig. 11. Stereographic construction for the direction of shear (τ) of the mineralized shear zone at G. Dara area.

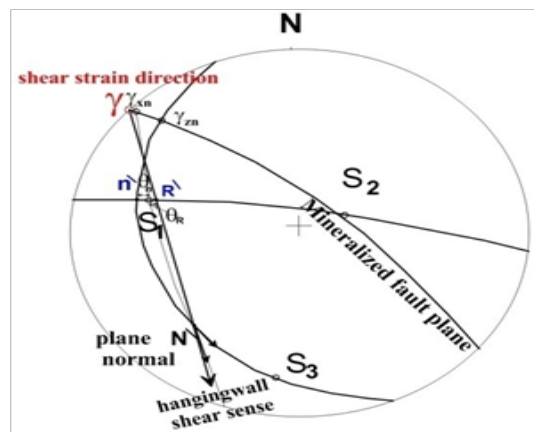

Fig. 14. Stereographic construction for the direction of strain (γ) of the mineralized shear zone at G. Hamrat Al Jirjab area.

Mineralogy

Mineralogy of G. Abu Harba area.

The ESEM study of the separated mineral grains at G. Abu Harba area revealed the presence of secondary uranium mineral kasolite [Pb(UO₂)(SiO₄).H₂O]; It is the only uranyl silicate with lead as a significant cation and is a hydrated silicate of lead and hexavalent uranium. This mineral generally occurs either as minute dispersions or microfracture infillings and coatings on surfaces of hematitized joints. EDX analysis indicated that the uranium content is 45 wt%.

Chlopinite (UTi₄Nb₂O₁₇) uranium mineral with uranium content equals 20 wt.%, associated with iron mineral pseudo-brookite Fe₂TiO₂ (Fig.15) are also detected. Another type of mineral is identified, which is considered as one of the radioactive rare earth ore minerals, Cerite

with the chemical formula (Ce,La,Ca)₉Fe³⁺(SiO₄)₆(SiO₃)(OH)₄. Depending on the contents of both cerium (Ce) and lanthanum (La), there are (Ce) rich species (cerite-(Ce)) and (La) rich species (cerite-(La)). The detected mineral at G. Abu Harba mineral is (cerite-(Ce)) (Fig.16) as it contains (Ce) with an amount 31.35 wt.% greater than (La) which present with content equal 17.14 wt.%. Due to uranium (U=0.63wt.%) and thorium(Th= 1.89 wt.%) impurities, cerite is radioactive. Other rare-earth elements such as samarium (Sm), Gadolinium (Gd) Neodymium (Nd) and Praseodymium (Pr) are also present with different amounts.

Mineralogy of G.Dara area.

The identified minerals at G.Dara area can be grouped into two groups as radioactive and REE-bearing minerals such as xenotime, cyrtolite and ishikawaite and non-radioactive bearing minerals as columbite and magnetite.

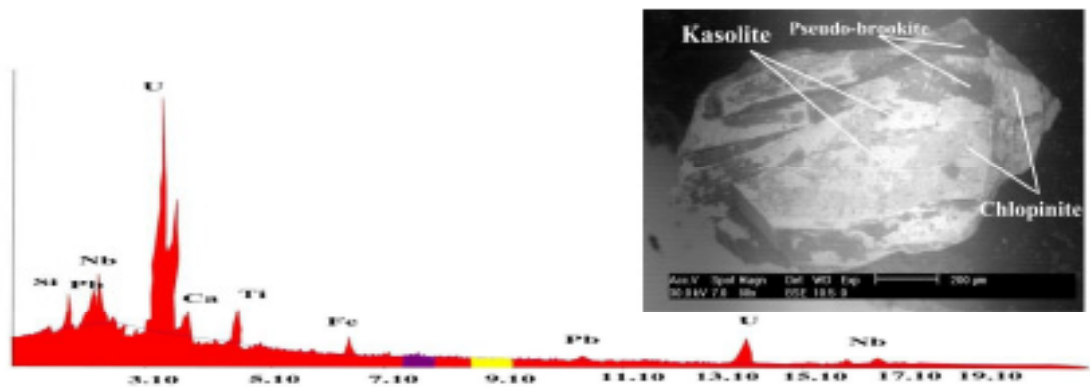

Fig.15. Back-scattered electron image and EDX chart of kasolite, chlopinite and pseudo-brookite minerals, G. Abu Harba area.

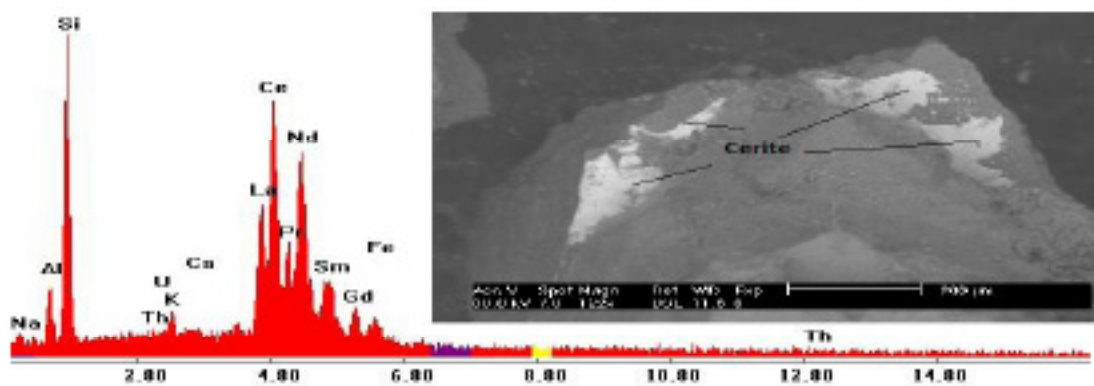

Fig.16. Back-scattered electron image and EDX chart of cerite mineral, G. Abu Harba area.

Xenotime (YPO₄)

Xenotime is registered only in G.Dara area. It is found as anhedral fine crystals interstitial the iron oxide minerals. The major component of which is yttrium orthophosphate (YPO₄). The ESEM image and EDX analysis of xenotime are displayed in Figure (17). Rare-earth elements dysprosium (Dy), erbium (Er), Gadolinium (Gd) and ytterbium (Yb), as well as, metal elements such as thorium and uranium (all replacing yttrium) are the expressive secondary components of xenotime. It contains Y with an amount equal to 24.02 wt.%, Gd = 0.55wt.%, Dy= 1.26wt.%, Er= 1.45wt.% and Yb= 4.50wt.%, and don't contain any radioactive elements (uranium or thorium).

Cyrtolite [ZrSiO₄ (Th, U)].

Cyrtolite is a type of zircon caring radioactive elements as Th and U, it is a tetragonal system with rounded, almost dome-shaped crystals, and found metamict due to the occurrence of Th, 5.66 and U, 5.70 (Fig.18).

Ishikawaite [(U,Fe,Ca)(Nb,Ta)O₄].

Samaraskite is a collection of Nb-Ta mineral variations with the general formula AmBnO₂(m+n), where A refers for Fe²⁺, Ca, REE, Y, U, and Th, and B refers for Nb, Ta, and Ti. The samarskite group of minerals is divided into three species: If REE+Y is the major cation, the word samarskite-(REE+Y) is used, If U+Th are dominant, the mineral called ishikawaite and if Ca is the major cation, it is called calciosamaraskite (Hanson et al. 1999). In addition, the mineral samarskite-(Yb) has been detected (Simmons et al. 2006). The mineral of samarskite was named Ishikawaite, due to its large occurrence in the Ishikawaite area in Japanese. The chemical formula of ishikawaite minerals obtained Y and others not contain Y. the analyses using ESEM data (Fig.19) show that Nb and U are the essential components with an amount 35.94 and 31.30 wt. % respectively. Other elements present in small to minor amounts include Ta, Nd, Mn, La, Ce, Pr, Sm, Ti, Ca and Si. The distribution of uranium within the crystals is heterogeneous and its content increase in the bright parts.

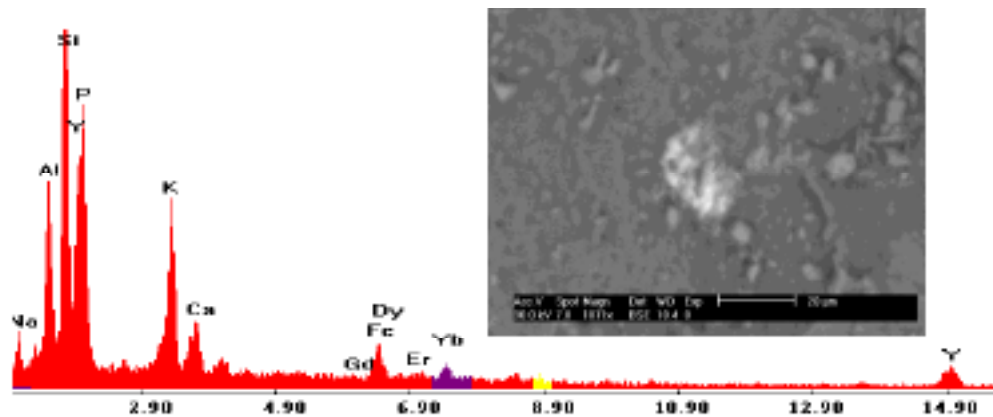

Fig.17. Back-scattered electron image and EDX chart of Xenotime mineral, G. Dara area.

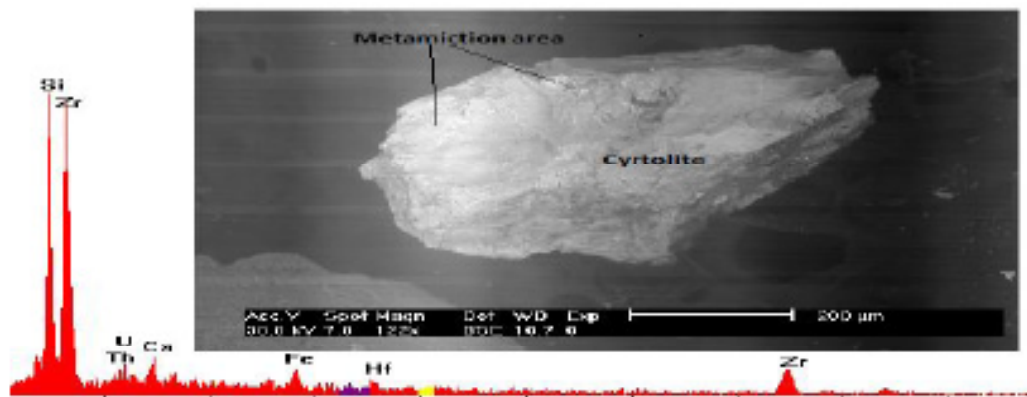

Fig.18. Back-scattered electron image and EDX chart of cyrtolite mineral, G. Dara area.

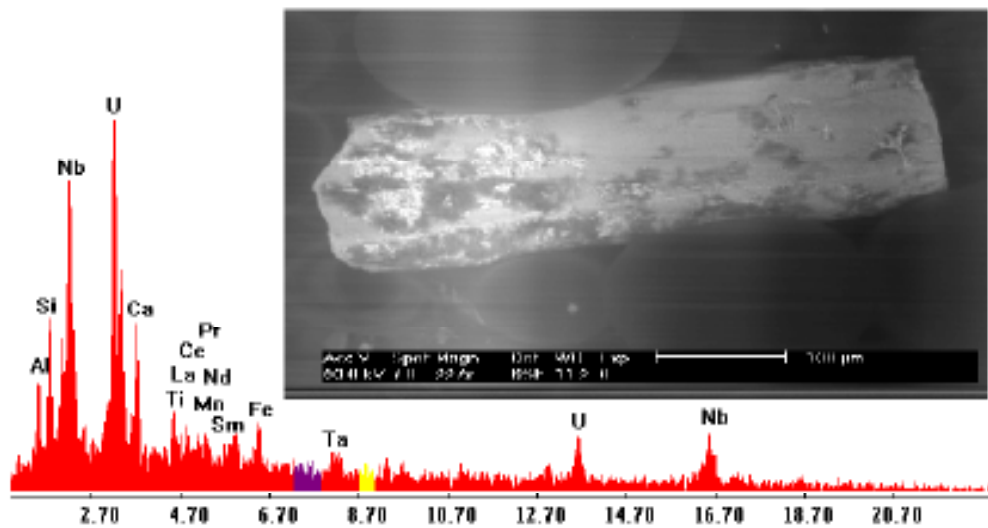

Fig.19. Back-scattered electron image and EDX chart of Ishikawaite mineral, G. Dara area.

Columbite [(Fe, Mn)₂Nb₂O₆]

The columbite minerals are a series formula: Fe₂Nb₂O₆ to Mn₂Nb₂O₆

Minerals of the columbite-tantalite group have the general formula AB₂O₆ with the A site occupied by iron (Fe), manganese (Mn) and a smaller quantity of magnesium (Mg), trivalent ions, and the B site occupied by niobium (Nb), tantalum (Ta) and low quantities of titanium (Ti). The isovalent substitutions (Fe) ↔ (Mn) in the A site are the primary trends recognized from the literature and the members ferrocolumbite, manganocolumbite, ferrotantalite and manganotantalite are named based on the presence of Fe and Mn, as well as Nb and Ta. These minerals are orthorhombic system, crystal class dipyramid. The columbite, in the investigated area, occurs as Manganocolumbite: (Mn)₂(Nb, Ta)₂O₆ and Ferrocolumbite: (Fe)₂(Nb, Ta)₂O₆ with an amount of (Ti)(Fig.20).

Magnetite (Fe₃O₄)

Magnetite, with the chemical formula Fe₃O₄, is one of the most common iron ores. It predominates iron oxide mineral detected in G.Dara area. The occurrence of magnetite is indicated the presence of primary iron minerals in G. Dara area (Fig.21).

Mineralogy of G.Hamrat Al Jirjab.

Mineralogical studies of the heavy minerals grains revealed the abundance of Thorite(ThSiO₄), uranium-rich variety of Thorite such as Uranothorite(Th,U)SiO₄ and Enal-

ite (Th,REE,Al) [(PO₄),(SiO₄),(OH)]. Ekanite (Ca,Fe,₂(Th,U)Si₈O₂₀) is a radioactive mineral crystallized in a tetragonal system as Trapezohedral was also detected. ESEM image and EDX spectrum of above mentioned minerals are illustrated in figure (22). These minerals are recorded only in G.Hamrat Al Jirjab area and represent the main Th-bearing mineral in the studied samples.

Zircon (ZrSiO₄)

Zircon is the most recognizable heavy mineral that is found in G.Hamrat AlJirjab area. It forms the major Zr-U-REE (Ce) bearing mineral in this radioactive zone, uranium and REE (Ce) (Fig.23) are present in the form of dark patches hosted by zircon crystal by an amount equal to 6.4 and 2.19wt.%respectively, it is characterized by its bipyramidal shape.

Monazite, (La,Ce,Nd,Th,U)PO₄

Monazite is a radioactive mineral due to the presence of thorium with an amount equal to 25.43 wt.% and, less commonly, uranium with an amount equal to 6.55 wt. % and it is also being a major host for REE((La= 4.82wt.%, Ce= 1.21wt.%, Pr= 1.1 wt.%, Nd=2.67 wt.% and Sm =1.39 wt.%), The semi-quantitative analysis (EDX) (Fig.24)of the studied monazite shows that La is the dominant cation and so this monazite can be referred as monazite-(La). its concentrations are higher in G.Hamrat Al Jirjab area.

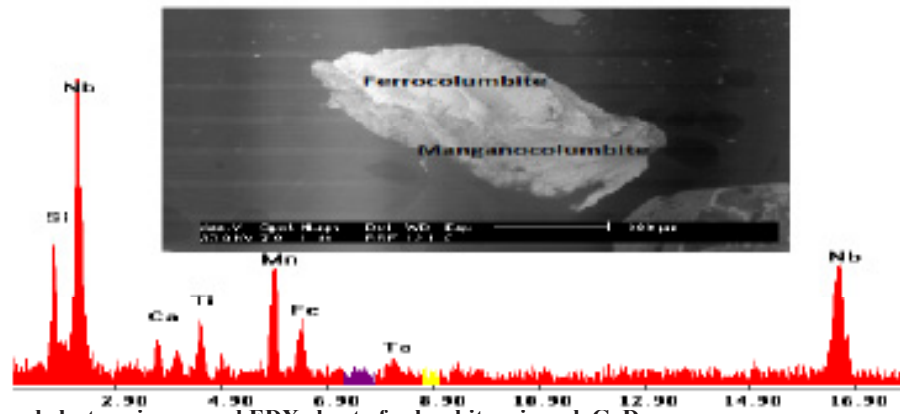

Fig.20. Back-scattered electron image and EDX chart of columbite mineral, G. Dara area.

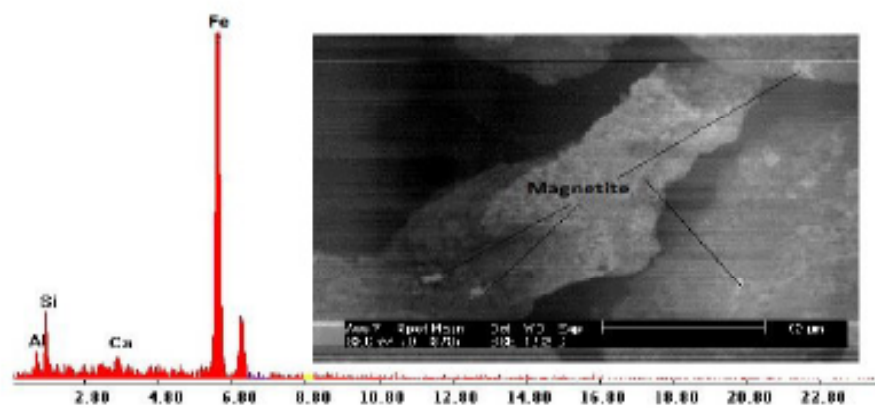

Fig.21. Back-scattered electron image and EDX chart of magnetite mineral, G. Dara area.

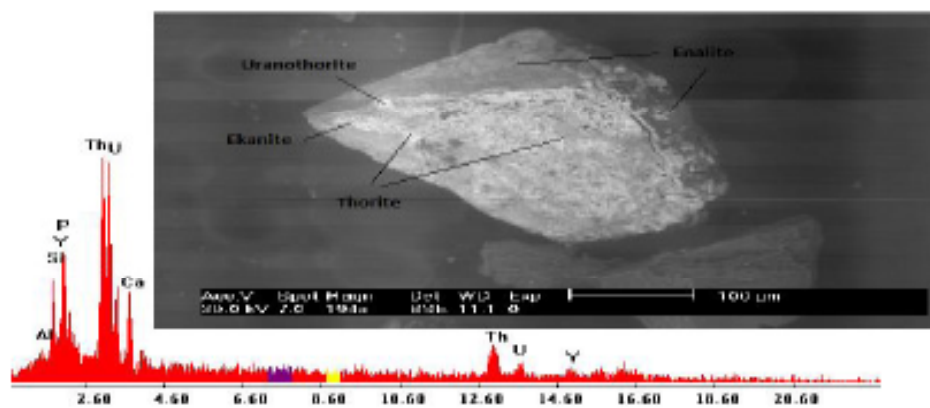

Fig.22. Back-scattered electron image and EDX chart of Thorite, Uranothorite, Enalite and Ekanite minerals, G. Hamrat Al Jirjab area.

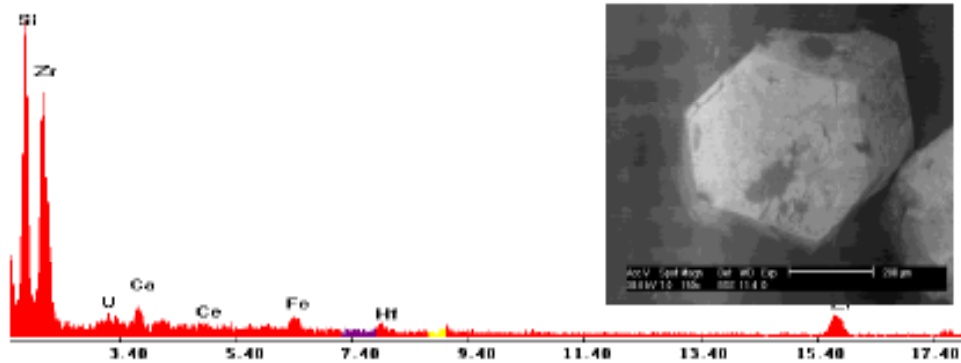

Fig.23. Back-scattered electron image and EDX chart of zircon mineral, G. Hamrat Al Jirjab area.

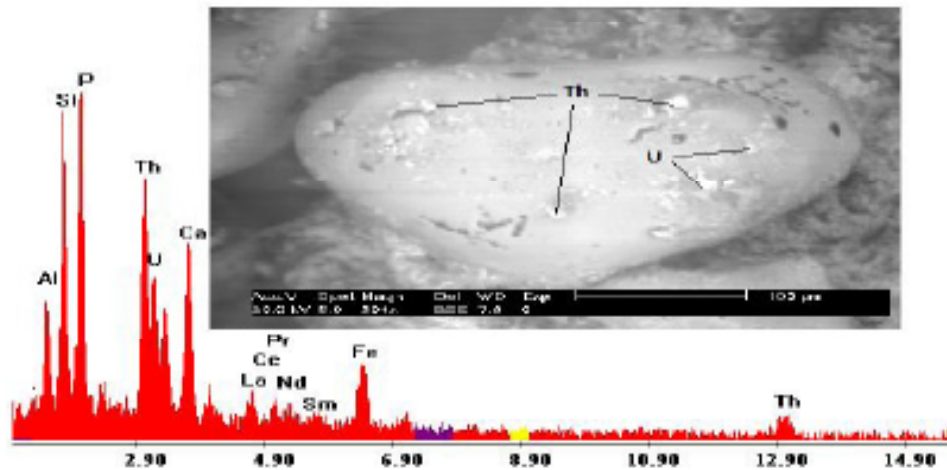

Fig.24. Back-scattered electron image and EDX chart of monazite mineral, G. Hamrat Al Jirjab area.

Discussion

The uranium occurrences at both G.Abu Harba and G.Dara areas are recorded along normal fault zone or shear zone trending in the same direction (N15°W) with dips also the same of about (86°) to SW and NE respectively; while the uranium occurrence at G. Hamrat Al Jirjab are it is along sinistral strike slip fault trending N50°W with dip equal 70° to NE.

The structural analysis of compared areas indicates that the direction of shear stress required initiating slip on both G. Abu Harba and G. Dara mineralized shear zones is directed N-S and G.Hamrat Al Jirjab mineralized shear zone is directed NNW-SSE. The shear strain on both G. Abu Harba and G. Dara mineralized shear zones is

pitched by an amount 87° and 82° to E respectively, while, G.Hamrat Al Jirjab mineralized shear zone pitches by an amount equal 42° to W.

The mineralogical studies for the investigated areas indicated that the ishikawaite, cyrtolite and xenotime are the main detected radioactive and REE-bearing minerals at G.Dara area and Kasolite, chlopinite and cerite minerals are radioactive and REE-bearing minerals at G. Abu Harba area. Thorite, uranothorite, enalite, ekanite, monazite and zircon minerals are radioactive minerals at G. Hamrat Al Jirjab area. In addition, the presence of columbite and magnetite is associated with radioactive minerals at G. Dara area; while the pseudo-brookite iron mineral is associated with radioactive bearing minerals at G. Abu Harba area.

Conclusion

The structural analysis of the studied areas indicates that The radioactive minerals at G.Abu Harba area and G. Dara it is recorded along the same type of fault zone or shear zone(normal); trending in the same direction (NNW) with the same dip of amount. Also, the direction of shear stress required initiating slip on both G. Abu Harba and G. Dara mineralized shear zones is the same and it is directed N-S; while the radioactive minerals at G.Hamrat Al Jirjab mineralized shear zone are detected along sinistral strike slip fault trending NW with moderately steep dip to NE and the direction of shear stress required initiating slip on this shear zone is directed NNW-SSE slightly shifted from N-S direction of the other two areas.on the other hand, the shear strain on both G. Abu Harba and G. Dara mineralized shear zones pitches by the same amount (87° and 82° respectively) and at the same direction (E); while G.Hamrat Al Jirjab mineralized shear zone pitches by a different amount equal 42° to the opiset direction (W) of the other two areas.

The mineralogical study of the separated mineral grains at compared areas revealed the presence of two groups of minerals:(1) radioactive and REE-bearing minerals. (2) non-radioactive bearing minerals.

Ishikawaite, cyrtolite and xenotime represent the first group minerals and columbite and magnetite represent the second group minerals at G.Dara area. Kasolite, chlopinite and cerite minerals are radioactive and REE-bearing minerals; while, the pseudo-brookite iron mineral is a non-radioactive bearing mineral at G. Abu Harba area. Thorite, uranothorite, enalite, ekanite, monazite and zircon minerals are radioactive minerals at G. Hamrat Al Jirjab area. The uranium minerals are considered as the main detected radioactive minerals at G.Dara and G. Abu Harba areas while the thorium minerals are the main detected radioactive minerals at G. Hamrat Al Jirjab area.

Reference

- AbdelHadi, A.M. (2013) Mineralogical and geochemical prospection and radioelements distribution in Hamrat Al Jirjab stream sediments, Esh El Melaha range, North Eastern Desert, Egypt. *Ph.D. Thesis, Benha Univ., Fac. Sci.*, 251p.
- Delvaux, D. and Sperner, B. (2003) New aspects of tectonic stress inversion with reference to the TENSOR program, *Geological Society, London, Special Publications*. (212): 75-100.
- El-Desoky, H.M. and Hafez, H.M. (2018) Petrology, Geochemistry and Mineralogy of the Hydrothermally Altered Rock Units at Wadi Dara, *North Eastern Desert, Egypt. Annals, Geol. Surv. Egypt*, (XXXV): 103 – 140
- El Kholly, D.M. (1995) Geology and radioactivity of Esh El Mellaha range with emphasis on the granite of Gebel Homra El Gerigab, *Ph.D. Thesis, Geol. Cairo Univ., Egypt*, 225 p.
- El-Mansi, M.M., Dardier, A.M. and Moussa, E.M. (2004) Geology and uranium distribution within the older granitoids and some granitic masses in the North Eastern Desert, *Egypt. Jour. of Geol.* (48): 101-114.
- El Sundoly, H. I. (2021) Structural features and incremental stress history of the granites of Wadi Dara area, Northern Eastern Desert, *Egypt. Middle East Journal of applied sciences*, **11**, (2): 383-398.
- El Sundoly, H. I. and Waheeb, A. G. (2021) Tectonic events at Gabal Hamrat Al Jirjab area and its relation with radioactivity of the area, *North Eastern Desert, Egypt. Annals, Geol. Surv., Egypt*, (XXXVIII): 221-241.
- Bennet, J.D. and Mosley, P.N. (1987) Tiered tectonics and evolution, Eastern Desert and Sinia, Egypt. In: Matheis, G. and Schandelmeier, H.(eds) *Current Research in African Earth Sciences.Balkema, Rotterdam*, pp: 79-82.
- Cuney, M. (2009) The extreme diversity of uranium deposits, *Mineralium Deposita*, (44): 3-9.
- Genna, A., Nehlig, P., Le Goff, E., Guerrot, C. and Shanti, M. (2002) Proterozoic tectonism of the Arabian Shield, *Precambrian Research*, (117): 21-40.
- Hanson, S.L., Simons, W.B., Falster, A.U., Foord, E.E. and Lichte, F.E. (1999) Proposed nomenclature for samarskite-group minerals: new data on ishikawaite and calciosamarskite, *Mineral. Mag.*, (63): 27-63.
- Kröner, A., Greiling, R., Reischmann, T., Hussein, I.M., Stern, R.J., Durr, S., Krugger, J. and Zimmer, M. (1987) Pan-African crustal evolution in the Nubian segment of north-eastern Africa. In: Kröner, A. (Ed.), *Proterozoic Lithospheric Evolution Am. Geophys. Union Geodynamic Series*, (15): 235-257.
- Lisle, R.J. (1998) Simple graphical constructions for the direction of shear, *J. Struc. Geol.*, **20**, (7): 969 - 973.

- Rashwan, A. A., Shalaby, M. H., Roz, M. E., Wetait M. A. and AbdelHamid, A. A. (2013) Alkalic-metasomatism and redistribution of U, Th and REE in the hydrothermally altered granite of Gabal Abu Harba, North Eastern Desert, Egypt, *Nuclear Science Scientific journal*, (2): 23-37.
- Roz, M.E. (2001) Geology and uranium potentialities in Gabal Abu Harba environs, North Eastern Desert, Egypt, *Ph.D. Thesis, Cairo Univ., Egypt*, 264 p.
- Salman, A.B., Nossair, L.M. and El Kholy, D.M. (1995) Contribution to the radioactivity of Gabal Homra El Gerigab, Esh El Mellaha range, north Eastern Desert, Egypt, *Annals, Geol. Surv. Egypt*. (XX): 725-743.
- Shalaby, M.H. (1985) Geology and radioactivity of W. Dara area, North Eastern Desert, Egypt, *Ph. D. Thesis, Alex. Univ.*, 165p.
- Simmons, W.B., Hanson, S.L. and Falster, A.U. (2006) Samarskite–Yb: A new species of the samarskite group from the Little Patsy pegmatites, *Jefferson County, Colorado, Canadian Mineralogist*, **44** (5): 1119-1125.
- Stern, R.J. and Hedge, C.E. (1985) Geochronology and isotopic constraints on Late Precambrian crustal evolution in the Eastern Desert of Egypt, *Amer. J. Sci.* (285): 97-127.
- Waheeb, A.G. (2016) Determination of tectonic regimes at Gabal Abu Harba granites and their relation to the distribution of secondary uranium minerals, North Eastern Desert, Egypt, *Egypt. J. Geol.*, (60): 212-230.

مقارنة بين المعادن المشعة المرتبط تواجدها بوجود تراكيب جيولوجية بالجرانيتات الفلسية في جبل أبو حربة وجبل دارا وجبل حمرة الجرجاب، شمال الصحراء الشرقية، مصر

أنطون جورج وهيب، وجوزيف ميخائيل سمعان

هيئة المواد النووية، القاهرة، جمهورية مصر العربية

تتميز الجرانيتات الفلسية في مناطق جبل أبو حربة وجبل دارا وجبل حمرة الجرجاب بوجود مناطق إجهاد مشعة. حيث توجد المعادن المشعة في منطقتي أبو حربة ودارا على طول نطاق إجهاد أو صدع يضر في نفس الاتجاه بكلا المنطقتين، وهو اتجاه شمال ١٥ درجة غرب وهذين الصدعين لهما نفس النوع، حيث إنهما صدوع عادية ولهما نفس الميل الذي يبلغ حوالي ٨٦ درجة، ويتراوح مقدار إشعاع جاما المقاس في هذه الشاذات بين ١٨٠٠ جزء في المليون و ٢٤٠٠ جزء في المليون؛ في حين أن المعادن المشعة بجرانيتات جبل حمرة الجرجاب توجد على طول صدع مضرب يساري يضر في اتجاه شمال ٥٠ درجة غرب بمقدار ميل ٧٠ درجة في اتجاه شمال شرق، ويصل مقدار إشعاع جاما بها إلى ٢٢٠٠ جزء في المليون.

الإجهاد اللازم لبدء الحركة على نطاقات الصدوع المتمعدنة بمعادن مشعة في كلا من منطقتي جبل أبو حربة وجبل دارا يتجه في نفس الاتجاه (شمال – جنوب) في تلك المنطقتين، بينما في منطقة حمرة الجرجاب يتجه في اتجاه آخر (شمال شمال غرب – جنوب جنوب شرق). كما إن الانفعال بمنطقتي أبو حربة ودارا أيضاً يكاد يكون متطابق، (يميل بمقدار ٨٧ درجة بجبل أبو حربة وبمقدار ٨٢ درجة بجبل دارا في اتجاه واحد لكلاهما وهواتجاه الشرق)، بينما بجبل حمرة الجرجاب يميل بمقدار ٤٢ درجة في اتجاه الغرب.

وقد كشفت الدراسة المعدنية بتلك المناطق أن معادن اليورانيوم هي المعادن المشعة الرئيسية المكتشفة في منطقتي جبل دارا وجبل أبو حربة، بينما تعد معادن الثوريوم أهم المعادن المشعة المكتشفة في منطقة جبل حمرة الجرجاب.