



Experimental Investigation on the performance of Silica Gel Desiccant Wheel

دراسة عملية حول عجلة دوارة من السيليكا جل

E.Elnegiry, A.Ramzy and M.Allam

KEYWORDS:

Desiccant wheel, HVAC system, Regeneration temperature, Solid desiccant and Adsorption

المخلص العربي: إن مشكلة زيادة استهلاك الطاقة تمثل تحديات كبيرة بالنسبة لنظام تكييف الهواء، لذلك يتم استخدام عجلة التجفيف مع نظام تكييف الهواء لتقليل استهلاك الطاقة. ويتم استخدامها أيضاً للتحكم في نسبة الرطوبة لمختلف العمليات الصناعية والتجارية. الهدف من هذا البحث هو تصميم عجلة تجفيف دوارة لدراسة أدائها وهي عبارة عن شكل اسطواني قطره 400 ملليمتر ارتفاعه 110 ملليمتر ومملونه بماده السيليكا جل. وقد تم دراسة تأثير بعض العناصر على أداء عجلة التجفيف مثل دراسة تأثير تغير درجة حرارة الهواء الساخن وتغير معدل تدفق الهواء البارد وتغير سرعه دوران عجلة التجفيف حيث أنه يتم قياس درجة الحرارة ونسبه الرطوبه عند مخرج عجلة التجفيف. وقد استخدمت النتائج التي تم الحصول عليها في حساب بعض العوامل مثل فعاليه ازاله الرطوبه ومعامل ازاله الرطوبه ومعامل نسبه الطاقه المحسوسه. قد وجد ان أقصى فعاليه لازاله الرطوبه عند درجة حراره 110 درجة مئوية وسرعه دوران لعجله التجفيف 2 لفه في الدقيقة ومعدل تدفق للهواء البارد 1.8 كجم/دقيقه.

Abstract— The energy penalty is the main problem of the air conditioning system, so desiccant wheel (DW) is integrated with HVAC system to reduce the overall energy consumption, also DW extensively used for humidity control for various industrial and commercial processes. The aim of this paper is to construct and design a rotating DW to study its performance. The DW is filled with silica gel and has a cylindrical shape of 400 mm diameter and 110 mm thickness. The impact of different operational parameters such as the impact of regeneration temperature, flow rate and rotational speed on the performance of the wheel has been investigated. The temperature and humidity ratio at the outlet of DW are measured. The obtained results were used to calculate some parameters for the wheel such as the dehumidification effectiveness, the dehumidification coefficient of performance and the sensible energy ratio. It was found that the maximum dehumidification effectiveness occurs at regeneration temperature of 110 0C, rotational speed of 2rph and process air flow rate of 1.8 kg/min and maximum DCOP occurs at regeneration temperature of 65 0C, rotational speed of 2rph and process air flow rate of 2.4 kg/min.

Nomenclature

D	diameter of desiccant wheel (m)
L	thickness of desiccant wheel (m)
N	rotational speed of desiccant wheel (rph)
m'	mass flow rate (kg/min)
t	temperature (°C)
h_{fg}	latent heat of vaporization(kJ/kg)

Greek symbols

ω	air humidity ratio (g/kg d.a)
η	effectiveness (dimensionless)

Subscripts

1	process air inlet
2	process air outlet
3	regeneration air inlet
4	regeneration air outlet
deh	dehumidification
pro	process
reg	regeneration
d.a	dry air

Abbreviations

DW	desiccant wheel
DCOP	dehumidification coefficient of performance (dimensionless)
SER	sensible energy ratio (dimensionless)
DBT	dry bulb temperature(°C)
WBT	wet bulb temperature(°C)

Received: 28 March, 2016 - accepted: 9 May, 2016.

E.Elnegiry, Associate Prof., Mechanical Power Dept., Fac. of Eng., EL-Mansoura Univ. (email: emadelnegiry@mans.edu.eg)

A.Ramzy, Lecturer, Mechanical Power Dept., Fac. of Eng., EL-Mansoura Univ. (email: ahmed_ara1979@mans.edu.eg)

M.Allam, Demonstrator, Mechanical Power Dept., Elameria integrated technical. (email: mohamedalam32@yahoo.com)

I. INTRODUCTION

Nowadays the DW is the heart of HVAC systems to reduce the cooling load and save energy. Low humidity air is needed for air-conditioning processes to create comfort conditions in building indoor. In traditional methods, the air is dehumidified by cooling it to a temperature lower than its dew point and condenses part of its moisture. After that more energy required to heat the condensed air to obtain a suitable temperature. Another method to dehumidify air is the use of a rotating

DW that has high capacity to attract moisture the desiccant material passes at two heating and cooling process to dehumidify the air. The first process is adsorption process in which desiccant material adsorbs the moisture because the vapor pressure at surface of desiccant material is lower than that of the surrounding air. The second process is desorption process in which the desiccant material desorbs the moisture because the vapor pressure at surface of desiccant material is higher than that of the surrounding air.

DW can provide energy efficient solutions for industrial applications [1] such as electronics protection, condensation prevention, injection molding, composite manufacturing, investment castings and corrosion prevention and other special cases requiring highly controlled humidity levels.

Other applications of DW are in commercial applications such as products drying, ice rinks, candy packaging, schools, supermarkets, and hospitals.

Several investigations have been performed to make studies on DW. Maiya et al. [2] showed that the dew point temperature of supply air for air conditioning integrated with the DW had a lower value compared with the conventional and reheat system to deliver the air with the same low humidity levels. Nia et al. [3] investigated DW performance. The simulation showed the impact of the working conditions on DW performance and on the optimal speed of the wheel.

Heidarinejad and Pasharshahri [4] and Yamaguchi and Saito [5] developed numerical model and compared the numerical results with the experimental data. They showed the impact of the regeneration air temperature, wheel thickness, air velocity and rotational speed on the DW performance by measuring the humidity and temperature distribution at the outlet of the process side of the DW. Angrisani et al. [6] studied the influence of the rotational speed on DW performance and the results are used to determine some of the effectiveness parameters such as dehumidification effectiveness, dehumidification coefficient of performance and sensible energy ratio. It was found that the maximum dehumidification performance occurs at the rotational speed of 5-10 rph. Ahmed et al. [7] developed a numerical model to study the design and operating parameters of DW and determined the optimum design parameters for operating conditions. Test facility for DW is designed and comparison between the numerical and experimental results is carried out. The results showed that there is an optimum operating speed of the wheel to increase its performance.

Other researchers focus on another desiccant material for dehumidification. Jia et al. [8] setup an experimental comparison of two DWs with composite desiccant material from lithium chloride and a silica gel and another wheel only with a silica gel. Different parameters, such as inlet air humidity, regeneration temperature, air mass flow rate which affect the performance of the DW were studied. The results indicated that the moisture removal capacity of the new composite DW is higher than that of the traditional silica gel wheel at the same temperature and relative humidity. Hamed et al. [9] developed a new system for dehumidification by using liquid desiccant. The system has been constructed to be tested. The impact of different parameters the absorption and regeneration processes such as the impact of process air and regeneration air inlet humidity, the process air and regeneration air flow rate, and bed length on the amount of water absorbed and desorbed in a cycle. Theoretical and experimental results are validated and show good agreement with each other. Beccali et al. [10] presented different sorts of solid desiccants and studied its impact on the performance of rotary DW. Jia et al. [11] used compound desiccant to develop the performance of the desiccant cooling system. Mathematical model validated with the experimental results. The results showed that the compound DW can remove higher moisture from the process air than of DW with the silica gel. Also the simulation results showed that it can use much lower thermal energy sources like solar energy or waste heat to work the cooling system with high relative COP.

There are other researchers developed the re-generation of the desiccant material of DW by using waste heat or by using renewable energy sources such as solar energy to minimize the cost of the electrical demand and save energy. Kabeel et al. [12] carried out an experimental work by using liquid desiccant to perform solar air conditioning. The influence of the solar radiation intensity, air flow rate system regeneration and absorption processes were studied.

Angrisani et al. [13] used waste heat from microgenerator to regenerate the desiccant material then studied the impact of the outdoor air humidity and regeneration air temperature on DW performance. Rambhad [14], regenerated various solid desiccants by using solar energy for dehumidification system and found that the desiccant has low maintenance and operating cost and has no effect on the environment.

The aim of this work is to design and construct desiccant dehumidification system to get maximum humidity removal for using in various applications. The effect of different operational parameters such as the effect of regeneration temperature, flow rate and rotational speed of DW on the performance of the wheel will be investigated by using inlet condition of 24°C DBT and 13 g/kg d.a humidity ratio. The dry bulb and wet bulb temperature of process air and regeneration air at outlet of DW are measured. Moreover, performance parameters will be calculated from the obtained results.

II. EXPERIMENTAL WORK

A. System Description

The aim of the experimental work is to study the performance of a rotary DW with variable parameters. An experimental system has been designed and built. The main components of the test rig are shown in the schematic diagram shown in Fig.1. Photograph of the system used is illustrated in Fig.2. The detailed design and operating parameters are listed in Table 1.

The system consists of:

1) A rotary DW of 0.40 m diameter and 0.11 m thickness and full of 10 kg of silica gel (shown in Fig.3). It is divided into two equal parts for regeneration and dehumidification processes. The two parts are carefully separated as shown in Fig.1.

2) Electrical D.C motor used to drive the DW at variable speed (2rph, 10rph, 20rph, 35rph, 60rph) by using adjustable speed drive that controls the speed.

3) Two blowers are used to supply air to the regeneration side and to process side through 1.75 m long. Dampers at the blower's inlet are used to adjust the flow rates (2.4 kg/min and 1.8kg/min). One blower and damper for process side and one blower and damper for re-generation side.

4) Electric heaters of 2 kw and 1 kw capacity are connected in series to preheat air entered to the regeneration

side. Thermostat are used to control the regeneration temperature of the exit air from the blower at the required values of (650C, 800C 1100C), which cover a wide range of operation of desiccants as recommended by ASHRAE 2001.

B. Measuring instruments

The measured parameters are:

- The inlet and outlet dry bulb (DBT) and wet bulb temperatures (WBT) of process and regeneration air.
- Flow rate of process and regeneration air.
- The rotational speed of DW.

Thermocouples of type k are used to measure DBT and WBT. The measuring points are located at inlet of the DW and outlet of the Nozzle for both process side and regeneration side. The thermocouples are connected to temperature recorder (DM6801A+) with an accuracy of $\pm 0.10\text{C}$ and the measuring range of 50 to 13000C. The humidity ratio is determined from psychometric chart using DBT and WBT. The velocity of process air and regeneration air are measured using a digital anemometer type TENMARS (Air velocity Meter) TM-402 with an accuracy of ($\pm 2\% + 0.2$) m/s, and the rotating speed of the DW is measured by stop watch.

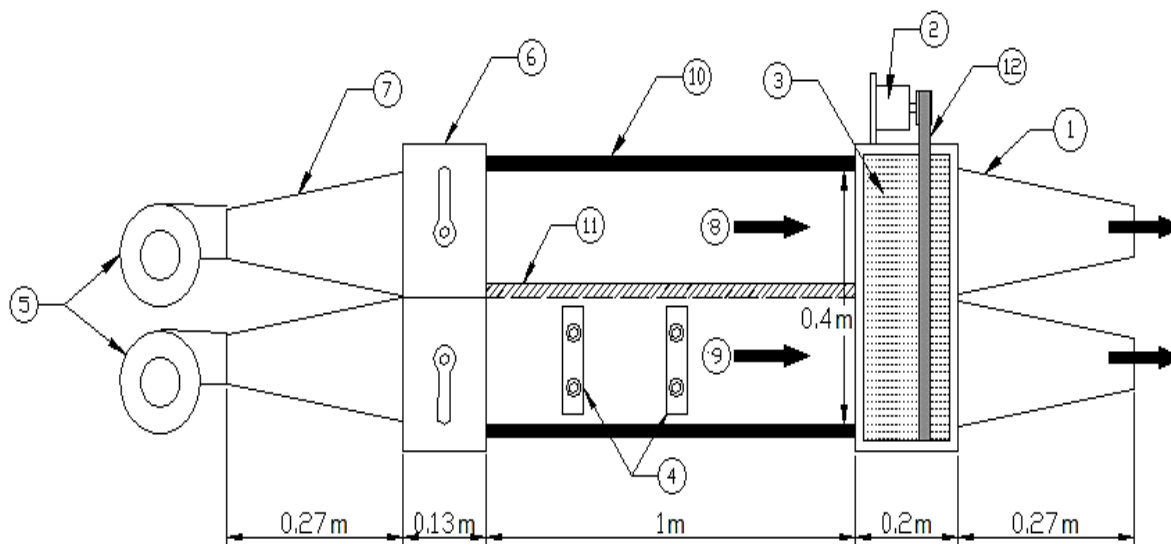

- | | |
|--------------------------------|----------------------------|
| 1) Nozzle. | 7) Diffuser. |
| 2) DC motor. | 8) Process air. |
| 3) Desiccant wheel. | 9) Regeneration air. |
| 4) Two Heaters of 2KW and 1KW. | 10) Glass wall insulation. |
| 5) Air fans. | 11) Cork sheet insulation. |
| 6) Volume damper. | 12) Rubber belt. |

Fig.1.Schematic of the test rig.



Fig.2. Photograph of the experimental test rig

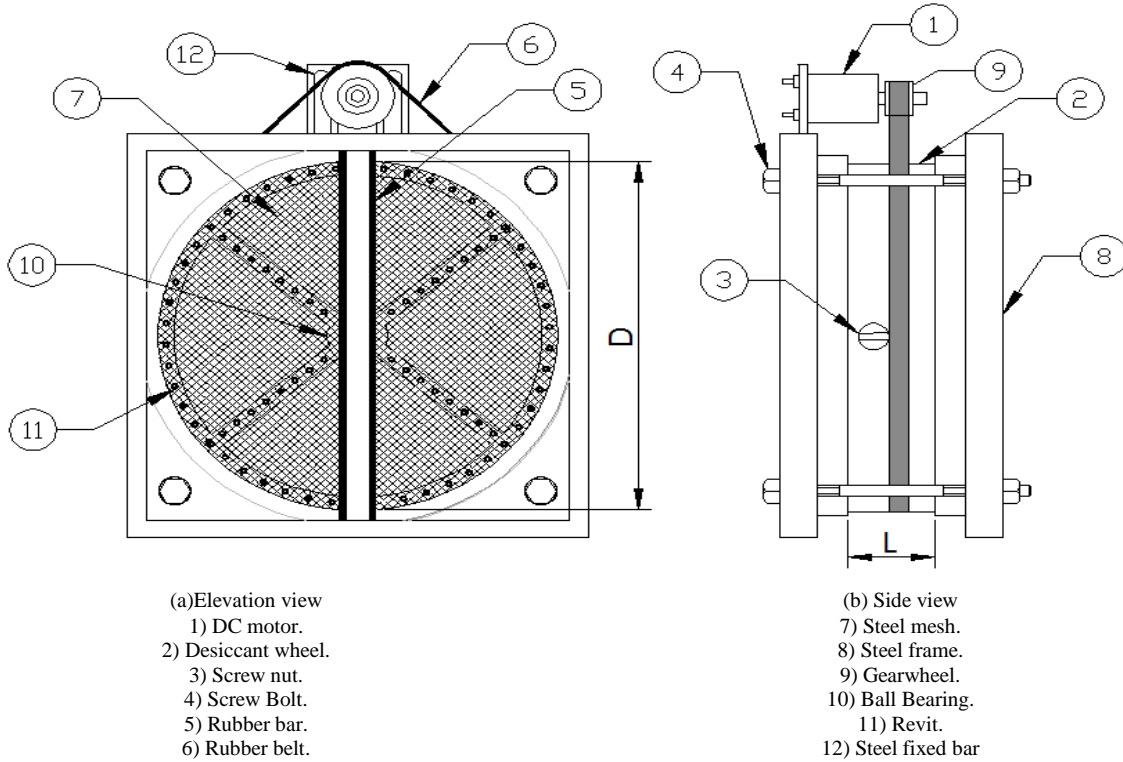

Fig.3. Details of desiccant wheel

C. System operation

The system is divided into dehumidification side and regeneration side. The two parts are carefully separated from inside and insulated. To start the operation, the two blowers, air heater and D.C motor are switched on. The temperature and humidity at both regeneration and dehumidification sides are recorded every 15 minute, regeneration temperature, rotational speed of the D.C motor and the flow rate of the process air are varied during the experimental tests. In dehumidification side, the humid process air passes through the dehumidification side of the DW, where the air is dehumidified by the adsorption of the water vapor to the silica gel wall and the air temperature is raised by generation of the adsorption heat.

TABLE 1
 DESIGN OPERATING PARAMETERS OF EXPERIMENTAL DESICCANT WHEEL.

Parameter	Value
Diameter of DW(D), mm	400
Thickness of DW(L), mm	110
Rotational speed of DW(N), rph	2,10, 20, 35, 60
process air flow rate (m_{proc}), kg/min	1.8, 2.4
Regeneration air flow rate (m_{reg}), kg/min	2.5
Regeneration air temperature (t_3), °C	65, 80, 110
Temperature of process air(t_1)	24
Inlet humidity(ω_1), g/kg d.a	13
Process area ratio, %	50
	13 , 24 g/kg dry air

In the regeneration side, the air is heated by air heaters, then air passes through regeneration side of the DW, where the desiccant is regenerated by desorption of the water and the regeneration air is humidified. This humid air is exhausted to the atmosphere.

D. Test facility

In order to evaluate the performance of the DW as a function of the rotational speed (N) and the regeneration temperature, the following performance parameters have been analyzed as shown in Figs.4 and 5 for process and regeneration air state points:

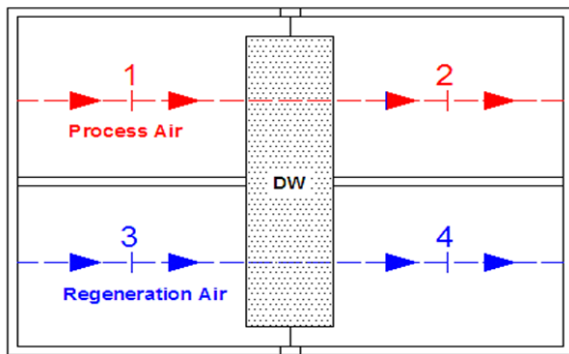

Fig. 4. Test facility section for experimental investigation of desiccant wheel.

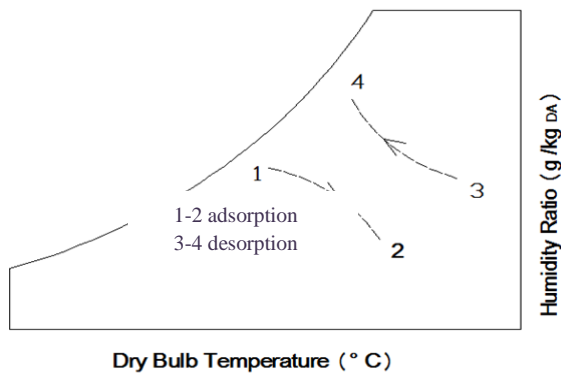

Fig.5. Psychrometric processes of the airflows in a desiccant wheel.

D:1) The dehumidification effectiveness, η_{deh} that represents the ratio between the humidity reduction across the wheel and the ideal dehumidification capability of the DW can be expressed as, [16]

$$\eta_{deh} = \frac{\omega_1 - \omega_2}{\omega_1 - \omega_{2ideal}} \quad (1)$$

Where ω_{2ideal} , is the ideal-specific humidity of the desiccant wheel. Assuming the air is completely dehumidified at this point, the value of ω_{2ideal} can be considered zero.

D:2) The Dehumidification Coefficient of Performance, DCOP, represents the ratio between the thermal power according to the air dehumidification and the thermal power

supplied for the regeneration process which is de-fined as, [6-17]:

$$DGOP = \frac{m_{proc} h_{fg}(\omega_1 - \omega_2)}{m_{reg}(h_3 - h_1)} = \frac{Q_{Latent}}{Q_{Regeneration}} \quad (2)$$

Where Q_{latent} and $Q_{Regeneration}$ are the vaporization latent heat rate of the adsorbed water and the input heat of regeneration rate respectively. m_{reg} is the regeneration air mass flow rate, m_{proc} is the process air mass flow rate, h_{fg} is the latent heat of vaporization of water (kJ/kg). h_{fg} has been evaluated by means of the following equation:

$$h_{fg} = -0.614342 * 10^{-4} t_1^3 + 0.158927 * 10^{-2} t_1^2 - 0.236418 * 10 t_1 + 0.250079 * 10^4 \quad (3)$$

D:3) The sensible energy ratio, SER, represents the ratio between the thermal power according to the air heating through the wheel on the process side and the thermal power supplied for the regeneration process, [6]:

$$SER = \frac{m_{proc}(h_2 - h_1)}{m_{reg}(h_3 - h_1)} \quad (4)$$

Higher values of η_{deh} represent better dehumidification performance as the humidity ratio output from the wheel has been reduced at a great rate compared to the inlet humidity ratio. A higher DCOP indicates a better system performance as the energy input to the regeneration air is utilized in a better way for better dehumidification in DW. On the other hand, a higher value of SER is undesirable, as it means a higher increase of the process air outlet temperature from the wheel and therefore a higher cooling load on the air conditioning unit.

III. RESULTS AND DISCUSSION

The effect of different operational parameters such as the effect of regeneration temperature, flow rate and rotational speed on DW performance has been investigated. The system is tested at the following conditions: Outdoor air = DBT = $24^\circ\text{C} \pm 1$ and $\omega_1 = 13 \pm 0.5$ g/kg d.a.

A. Effect of the rotational speeds

When the wheel was stationary, the silica gel contained amount of water vapor from surrounding air because it was in direct contact with the surrounding air. After the wheel had been rotated with constant speed of 2rph and regenerated by hot air in the regeneration side, the hot air desorbed the water vapor in silica gel and the outlet humidity changed with time. After 120 minutes passed, the outlet humidity reached steady state as shown in Fig.6. At high speed, the silica gel doesn't have enough time to adsorb the moisture from the air in the process side. likewise, the moisture contained in the silica gel cannot be completely desorbed in the regeneration side, so the minimum outlet humidity ratio was 6.6 g/kg d.a at lowest speed of 2 rph as shown in Fig.6.

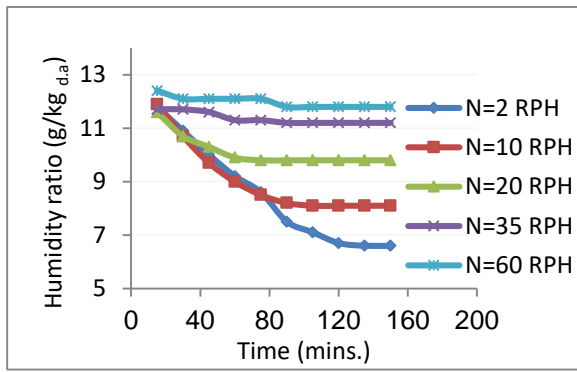

Fig.6.Outlet humidity of process air at different rotational speed during adsorption process - (m.proc=2.4 kg/min, t3=800C) .

The outlet process air humidity as well as rotational speed of the DW has been plotted at different regeneration temperature in Fig. 7, which shows that the moisture removal capacity increases with higher regeneration temperature. The reason for this is that a higher regeneration temperature results in higher vapor pressure at the desiccant surface compared with the surrounding air, so the moisture in the silica gel is much easier to desorb in the regeneration side and the silica gel can adsorb great amount of moisture in the process side at higher regeneration temperature. At regeneration temperature of 110 OC and low speed of 2 rph, the minimum outlet humidity ratio equal to 2.2 g/kg d.a .

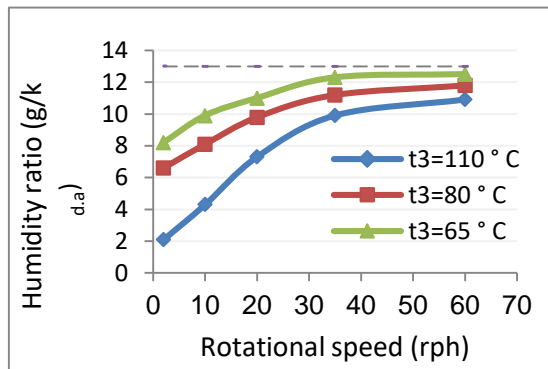

Fig.7. Effect of the rotational speed on the outlet humidity of process air at different regeneration temperatures during adsorption process (m.proc =2.4 kg/min)

The outlet temperature as well as rotational speed of the DW has been plotted at different regeneration temperature in Fig.8. Before DW was regenerated, the temperature of the air that leaving the wheel in process section is relatively high at inlet temperature of 24 OC, because the adsorption process generates sensible heat equal to latent heat of the water vapor adsorbed by the silica gel .Another sensible heat was added to the silica gel in the regeneration side after the DW was regenerated by hot air and the outlet process air temperature rises because of the rotation of the wheel from regeneration side to process side.

Moreover, the outlet process air temperature is low at lower rotational speed of the DW and then it becomes relatively high at DW higher speed, because at lower rotational speed the process air has enough time to cool the silica gel. In contrast at high rotational speed, the process air doesn't have enough time to cool the silica gel.

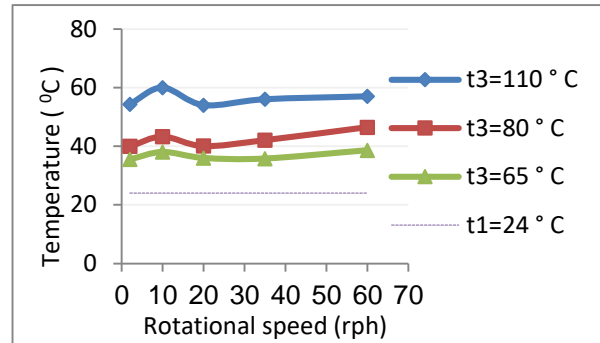

Fig.8.Effect of the rotational speed on the outlet temperature of process air at different regeneration temperatures during adsorption process (m.proc =2.4 kg/min).

The outlet humidity of regeneration air as well as rotational speed of DW has been plotted at different regeneration temperatures in Fig. 9, which shows that the outlet humidity ratio for the regeneration air increased with increase of the regeneration temperature and minimized and became nearly flat at higher rotational speed of the wheel

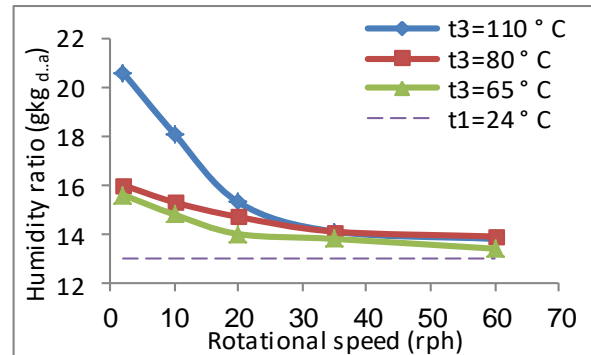

Fig.9. Effect of the rotational speed on the outlet humidity of regeneration air at different regeneration temperatures during regeneration process (m.proc =2.4 kg/min).

The maximum outlet humidity is 20.6 g/kg d.a at rotational speed of 2 rph and regeneration temperature of 110 OC. Fig.10 shows the increase of dehumidification effectiveness (η_{deh}) with regeneration temperature, because of the increase of difference between inlet and outlet humidity ratio of the process air at higher regeneration temperature as shown in Fig.6.

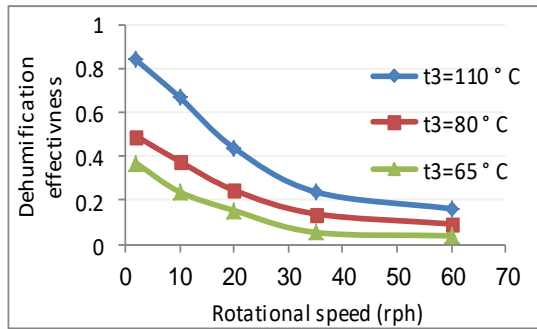

Fig.10.Effect of the rotational speed on the dehumidification effectiveness at different regeneration temperature during adsorption process (m.proc =2.4 kg/min).

Moreover, high rotational speed leads to decrease of η_{deh} due to decrease of the outlet humidity ratio. The maximum value of η_{deh} is 0.83 at regeneration temperature of 1100C and low rotational speed of 2rph, the minimum value of η_{deh} is 0.04 at regeneration temperature of 650C and high rotational speed of 60 rph.

Fig.11 shows that DCOP decreased with higher rotational speed of the DW .The reason of this is that a higher rotational speed leads to increase the outlet humidity of process air, so the difference between the inlet and the outlet humidity ratio is decreased ,then the amount of latent heat removed from process air is de-creased (Q.Latent) with constant rate of thermal energy (Q.Regeneration),therefore DCOP decreased .After the regeneration temperature had been increased, DCOP decreased because the in-crease in amount of latent heat removed with increase of regeneration temperature is not enough to balance the rise in regeneration thermal energy. At low regeneration temperature of 65 0C and rotational speed of DW of 2 rph, the thermal energy is utilized in better dehumidification capacity because the increase in amount of latent heat removed from process air is higher than the increase in thermal energy, thus the maximum value of DCOP is equal to 0.28. On the other hand, the thermal energy is higher compared with dehumidification capacity at high regeneration temperature of 110 0C and rotational speed of DW of 60 rph, thus the minimum value of DCOP is equal to 0.05.

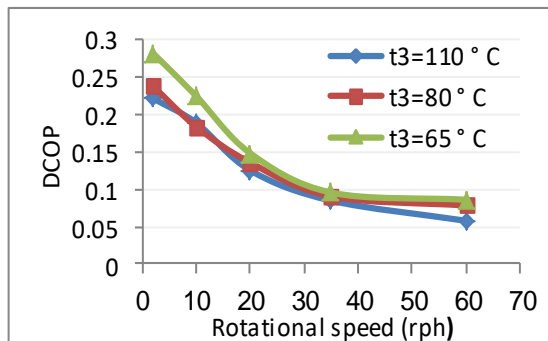

Fig. 11. Effect of the rotational speed on the dehumidification coefficient of performance at different regeneration temperature during adsorption process (m.proc =1.8 kg/min).

B The effect of flow rate of the process air

In Figs.12, 13 and 14, outlet humidity of process air as a function of the rotational speed for different air flow rates. Decrease in process inlet air flow rate at constant regeneration temperature leads to reduction in outlet process humidity ratio due to at low flow rate, the time of contact between inlet process air and silica gel surface is increased and the process air passes slowly through the silica gel that re-moved great amount of its moisture. At a higher regeneration temperature, the outlet humidity ratio is decreased, so according to the lowest process air flow rate of 1.8 kg/min, rotational speed of 2rph and inlet humidity ratio of 13 g/kg d.a, the minimum outlet humidity ratio at regeneration temperatures of 110 0 C, 80 0C, 65 0C are 1.5 g/kg d.a, 5.1 g/kg d.a , and 8.2 g/kg d.a respectively

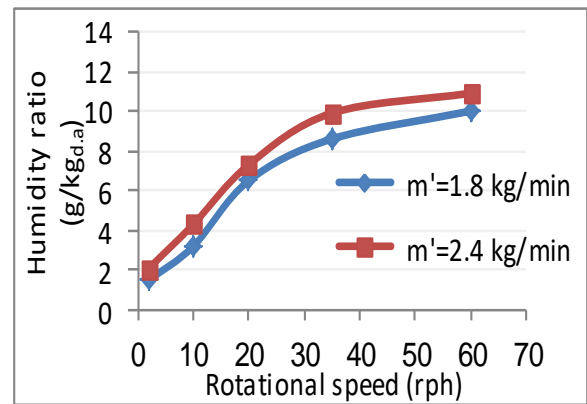

Fig.12. Effect of the rotational speed on the outlet humidity ratio of process air at different air flow rates during adsorption process at a regeneration temperature of 110o C

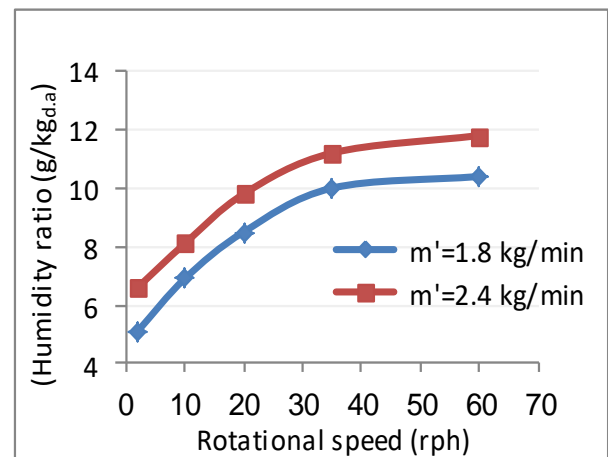

Fig.13 Effect of the rotational speed on the outlet humidity of process air at different at air flow rates during adsorption process at a regeneration temperature of 800 C

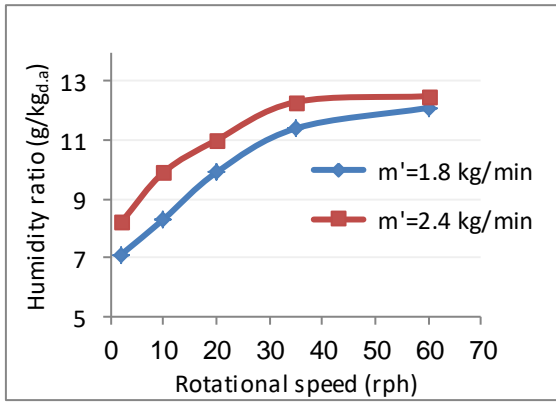

Fig.14. Effect of the rotational speed on the outlet humidity ratio of process air at different air flow rates during adsorption process at a regeneration temperature of 65o C.

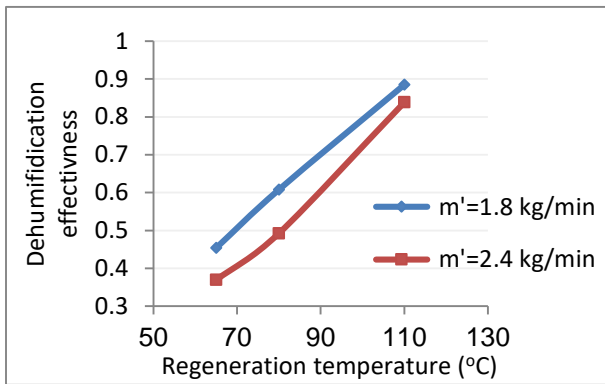

Fig.15. Effect of regeneration temperatures on the dehumidification effectiveness during adsorption process at different flow rates

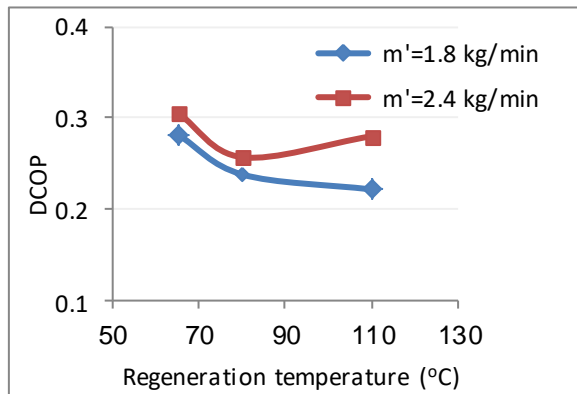

Fig.16. Effect of regeneration temperatures on the dehumidification coefficient of performance during adsorption process at different flow rates.

In (Figs.15-16), DCOP and η_{deh} as a function of the regeneration temperature are plotted for different process air flow rates. Under the same conditions of maximum regeneration temperature of 110 OC, there is a 20 % increase of DCOP when the velocity of process air increases from 1.8

kg/min to 2.4 kg/min. On the contrary η_{deh} decrease to about 10%. At the minimum regeneration temperature of 65oC, there is a 10 % increase of DCOP and η_{deh} de-crease to about 20 %. When the flow rate is increased, the outlet humidity ratio is increased that leads to reduction in moisture removal, so η_{deh} is decreased. However, the total moisture removal rate, which is obtained by multiplying the flow rate of process air and moisture removal, increases and thus high amount of latent heat adsorbed by silica gel. On the other hand, the thermal energy that generated by regeneration air is constant, and then DCOP increase.

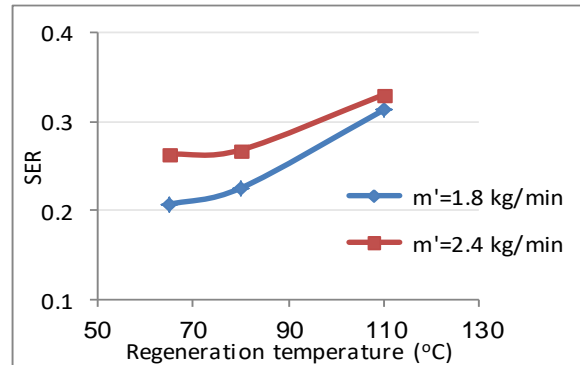

Fig.17. Effect of regeneration temperatures on the sensible energy ratio during adsorption process at different flow rates.

In Fig. 17, SER as a function of regeneration temperature for different process air flow rates. When the regeneration temperature increases, the SER increases because at higher regeneration temperature, the outlet temperature of process air increased that leads to increase of the difference between the inlet and outlet temperature of the process air and then SER in-creased. Moreover, at low flow rate there is an increase in the outlet temperature of the process air due to increase of the moisture removal in the process side and silica gel generate much heat in comparison with high flow rate of process air and then the difference between the inlet and outlet temperature of process air increased but on the other hand reduction of the mass flow rate leads to reduction of SER according to equation (4) of SER.

IV. CONCLUSION

Rotating DW is designed and built to study its performance parameters. The impact of the regeneration temperature, flow rate and rotational speed on its performance has been investigated. Performance parameters have been calculated from the experimental data. In conclusion, the experimental results from this paper are summarized at the following points:

- 1) The higher dehumidification effectiveness occurs at higher regeneration temperature of 110oC, rotational speed of DW of 2rph and flow rate of 1.8 kg/min.

- 2) The higher dehumidification coefficient of performance occurs at low regeneration temperature of 65°C, rotational speed of DW of 2 rph and flow rate of 2.4 kg/min.

REFERENCES

- [1] A. Pesaran, "A review of desiccant dehumidification technology," ERPI's Electr. De-humidification Energy Effic. Humidity Control Commer. Institutional Build. Conf., no. October, 1993.
- [2] N., M. P. Maiya, and S. S. Murthy, "Application of desiccant wheel to control humidity in air-conditioning systems," *Appl. Therm. Eng.*, vol. 24, no. 17–18, pp. 2777–2788, 2004.
- [3] F. E. Nia, D. van Paassen, and M. H. Saidi, "Modeling and simulation of desiccant wheel for air conditioning," *Energy Build.*, vol. 38, no. 10, pp. 1230–1239, 2006.
- [4] G. Heidarinejad and H. Pasharshahi, "The effects of operational conditions of the desiccant wheel on the performance of desiccant cooling cycles," *Energy Build.*, vol. 42, no. 12, pp. 2416–2423, 2010.
- [5] S. Yamaguchi and K. Saito, "Numerical and experimental performance analysis of rotary desiccant wheels," *Int. J. Heat Mass Transf.*, vol. 60, no. 1, pp. 51–60, 2013.
- [6] G. Angrisani, C. Roselli, and M. Sasso, "Effect of rotational speed on the performances of a desiccant wheel," *Appl. Energy*, vol. 104, pp. 268–275, 2013.
- [7] M. H. Ahmed, N. M. Kattab, and M. Fouad, "Evaluation and optimization of solar desiccant wheel performance," *Renew. Energy*, vol. 30, no. 3, pp. 305–325, 2005.
- [8] C. X. Jia, Y. J. Dai, J. Y. Wu, and R. Z. Wang, "Experimental comparison of two honeycombed desiccant wheels fabricated with silica gel and composite desiccant material," *Energy Convers. Manag.*, vol. 47, no. 15–16, pp. 2523–2534, 2006.
- [9] A. M. Hamed, A. Khalil, A. E. Kabeel, M. M. Bassuoni, and A. M. Elzahaby, "Performance analysis of dehumidification rotating wheel using liquid desiccant," *Renew. Energy*, vol. 30, no. 11, pp. 1689–1712, 2005.
- [10] M. Beccali, F. Butera, R. Guarella, and R. S. Adhikari, "Simplified models for the performance evaluation of desiccant wheel dehumidification," *Int. J. Energy Res.*, vol. 27, no. 1, pp. 17–29, 2003.
- [11] C. X. Jia, Y. J. Dai, J. Y. Wu, and R. Z. Wang, "Use of compound desiccant to develop high performance desiccant cooling system," *Int. J. Refrig.*, vol. 30, no. 2, pp. 345–353, 2007.
- [12] A. E. Kabeel, "Solar powered air conditioning system using rotary honeycomb desiccant wheel," *Renew. Energy*, vol. 32, no. 11, pp. 1842–1857, 2007.
- [13] G. Angrisani, A. Capozzoli, F. Minichiello, C. Roselli, and M. Sasso, "Desiccant wheel regenerated by thermal energy from a micro-cogenerator: Experimental assessment of the performances," *Appl. Energy*, vol. 88, no. 4, pp. 1354–1365, 2011.
- [14] K. S. Rambhad, P. V. Walke, and D. J. Tidke, "Solid desiccant dehumidification and regeneration methods—A review," *Renew. Sustain. Energy Rev.*, vol. 59, pp. 73–83, 2016.
- [15] American Society of Heating Refrigerating and Air-Conditioning Engineers, 2011 ASHRAE Handbook - HVAC Applications. 2011.
- [16] C. R. Ruivo, J. J. Costa, A. R. Figueiredo, and A. Kodama, "Effectiveness parameters for the prediction of the global performance of desiccant wheels - An assessment based on experimental data," *Renew. Energy*, vol. 38, no. 1, pp. 181–187, 2012.
- [17] T. S. Ge, F. Ziegler, and R. Z. Wang, "A mathematical model for predicting the performance of a compound desiccant wheel (A model of compound desiccant wheel)," *Appl. Therm. Eng.*, vol. 30, no. 8–9, pp. 1005–1015, 2010.