

Journal of Soil Sciences and Agricultural Engineering

Journal homepage: www.jssae.mans.edu.eg
Available online at: www.jssae.journals.ekb.eg

Development of An Electrical Sterilization Device for Stored Grains

El-Sayed, A. S. * and S. E. A. Mosa

Agric. Eng. Res. Institute, Agric. Rec. Center, Egypt



Cross Mark

ABSTRACT

This study aims to develop and fabricate a new device for electrical sterilization of stored grains by electrocution. This new device sterilizes directly infected grains and eliminates living organisms, whether they are whole insects, larvae or eggs. The electrocution destroys the moisture content of the organisms present only in the treated grains without affecting them. The device is equipped with a set of electronic circuits to automatically control the levels of electrocution, the speeds of the sieve, the motor and the auger carrying grains. Experiments were carried out at four grain auger speeds (0.262, 0.524, 0.785 and 1.047 m/s) with three levels of electrocution (3000, 6000 and 9000 volts) at two levels of electric sieve speed (0.220 and 0.283 m/s) with two levels of grain feed rate (0.18 and 0.36 Mg/h). The main results included that the percentage of insect mortality (sterilization efficiency) increased to 95.42% at the optimum levels of the tested variables. Also, the emergence rates of insect infestation reduced to 11.76% only after 1 month. The germination rate increased to 94.11%. Also, the percentage of mechanical damage and weight loss decreased to 5.13 and 4.43% respectively. The maximal productivity of the device reached 0.252 Mg/h at the optimum specific energy consumption rate of 1.98 kW.h/Mg with operating costs of 171.23 L.E/Mg. Therefore, the new device can be used inside grain stores and silos to perform sterilization operations periodically at the lowest production cost without the need for harmful chemical methods.

Keywords: Electro-sterilization; electrocution; sieve; mortality; infestation; germination.

INTRODUCTION

Grain storage is an agricultural process of important economic and strategic importance, as grain is stored for a period of time until it is sold, distributed, and consumed. The farmer also stores the grain for use as seed for the next planting season. During storage, grains are subjected to damage by the influence of several factors, including the moisture content of the grains to be stored, the temperature of the stored atmosphere, as well as the infestation of insects, fungi, and rodents (Dubale *et al.*, 2012). Grain consumption rates in Egypt exceed 42 million tons. The total wheat production in Egypt is about 9.34 million tons annually, which represents $\approx 25\%$ of the total amount of grain produced in Egypt (FAO, 2021). The best way to reduce the possibility of insects in stored grain is to carry out periodic sterilization of the grain. There are also modern methods, such as ultraviolet radiation sterilization, which are expensive and not commonly used (Hidaka and Kubota, 2006). Therefore, it must be kept intact without damage. The damage that can occur as a result of the storage process should be minimized, making it unfit for human or animal consumption because it has become toxic (Mahroof and Hagstrum, 2012). Stored grains contain microorganisms (fungi-yeasts-bacteria) and stored grains may contain insects in all their different stages, as the organisms accompanying the stored grains rapidly deteriorate the characteristics of the grains during storage (Strelec *et al.*, 2012). There are also many changes that can appear on the stored grains, which are chemical changes and biochemical changes represented in the changes resulting from the action of enzymes, whether they come from the grain itself or secreted by some organisms accompanying the stored grains, which ultimately lead to damage to the nutritional components of grains (Andric *et al.*, 2015). The changes resulting from the insect infestation as well as changes resulting from fungal infection due to

the toxins in the stored grain affect negatively the wheat grain contents such as proteins, fats, and vitamins (Fang and Arthur, 2002). Stored agricultural products such as grain are infested by more than 600 species of pest beetles, 70 species of moths and about 355 species of moths, causing quantitative and qualitative losses (Rajendran & Sriranjini, 2008). Insect infestations that affect granaries vary, such as the red flour beetle, in addition to some types of weevils, such as the white grain mite, (Kumar *et al.*, 2017).

Quality standards for stored grains in terms of their freedom from pests, insects and pesticide residues are one of the most important standards when exporting and importing. The moisture content of grains is also the decisive factor affecting grain storage (Semple, 1992). Storing grains and infecting them with insects leads to a rise in temperatures due to the respiration activity of insects. This in turn encourages more fungal growth, which leads to its contamination with some toxic substances, such as aflatoxin (Williams *et al.*, 2004; Atanda *et al.*, 2011). Insect pests injury increase the risk of grains and seeds stored in grains, such as grain weight loss, reduced germination and reduced nutritional value. Chemical insecticides are considered undesirable because they cause many diseases in humans and animals, in addition to their high cost (Gamal, 2018; Fileds, 2006). The continuous and indiscriminate use of chemicals has led to the development of resistant strains of pests (Ignatowicz, 2004). The unsafe use of chemical pesticides was carried out without control and without routine analysis of grain stored for long periods (Salem *et al.*, 2007). The major problem associated with chemical methods is that, even if they are applied carefully and in limited quantities, there is a possibility that these chemicals will remain in the food grain and have harmful effects on humans (El-Aziz, 2011).

* Corresponding author.

E-mail address: a.shawky71@yahoo.com

DOI: 10.21608/jssae.2021.205759

Modern biological methods, such as the use of nanotechnology, also include a new boom, but they remain limited in use due to their high cost (Chinnamuthu and Boopathi, 2009). The treatment of stored seeds with fungicides was found to be more beneficial by eliminating pests and fungi in storage to maintain better seed quality for a limited period not exceeding one year in onion seed yield (Santavec and Kocjanacko, 2011). The use of pulsed electric field (PEF) as a processing technology for stored grain is a clean and new method due to its energy efficiency, and one of its most important advantages is the consumption of lower energy values. Electric methods for sterilizing stored grain are the most viable solution, but there are no productive devices on the market. Electrical methods disinfect the grain by exposing the grain to an electric field in certain doses, which hinders reproduction and even causes the death of infected insects (Ahmad, *et al.*, 2019).

This research aims to develop and fabricate an electro-sterilization device for stored grains that can be used in silos and grain stores without using chemical methods. As well as determining the optimal levels for operating the new device and determining its impact on the quality of grain in terms of germination and mechanical damage. As well as reducing the rate of specific energy consumption by achieving maximum device productivity and reducing economic operating costs.

MATERIALS AND METHODS

General description

A new device has been developed and fabricated to sterilize stored grains electrically without the need for harmful and expensive chemical methods with residual effects such as fumigation. The grain insect infestation leads to serious damage to the grain, in addition to secreting some toxic substances and reducing its germination rate and quality. The developed device was provided with an electrical control unit equipped with electronic circuits to generate a large electrical potential difference of up to 9000 volts. The grain electro-sterilization device was also equipped with an auger for carrying grains and an electric reciprocating sieve to fit into stores and silos. In general, as shown in (Fig.1 & 2) and (Table 1), the newly developed device consists of the following parts.

Table 1. The technical specifications of the developed electro-sterilization grain device.

Dimensions (L× W× H)	(1350×1380×400 mm)
Net weight	123 kg
Height from the ground	675 mm
Inlet electrical voltage	220 V AC + 12 V DC
Capacity	Up to 0.225 Mg/h
Specific energy consumption	Up to 1.98 kW.h/Mg
Power source	AC 220 V motor
Electrocution voltage	3000 to 9000 V
Wheels	4 wheels 50 mm Dia. (solid type)
Grain conveying system	Auger with two opposite halves type
Grain sieve	Electrical reciprocating type
Motor speed control	Using speed control dimmer
Electrical insulation	Using wood, insulating paint and plastic
Used grains	Grains with an average diameter of 20 mm

Table 2. The technical specifications of the auger motor and the sieve reciprocating motor.

AC electrical motor		DC reciprocating motor	
Model	American	Model	Chinese
Operating voltage	220 V AC, 50 Hz	Operating voltage	12 V DC
Operating current	1.0 A	Operating current	1.5 A
Torque	91In-LBS	Power	240 W (0.322 Hp)
Power	229 W (0.307 Hp)	Rotation direction	360°
Weight	5500 gm	Weight	1200 gm
Rotation speed	1600 to 100 RPM (1:16)	Rotation speeds	35-45 RPM
Linear speeds	0.262 to 1.047 m/s	Linear speeds	0.220 0.283 m/s

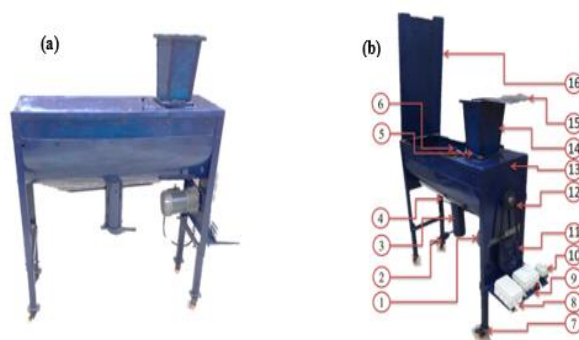

Fig. 1. The developed electro-sterilization device parts; (a) elevation view and (b) side view:

- 1- Auger AC motor (220V 50 Hz).
- 2- Grains shut cap.
- 3- Grains packing tube.
- 4- Sacks holder.
- 5- Grains slider controller.
- 6- Sieve DC reciprocating motor.
- 7- Wheels (50 mm Dia.).
- 8- DC controller.
- 9- Electrocution controller.
- 10- Auger motor switch.
- 11- Motor driving pulley.
- 12- Auger driven pulley.
- 13- Sieve position.
- 14- Grains hopper.
- 15- Hopper shut cap.
- 16- Upper grains door.

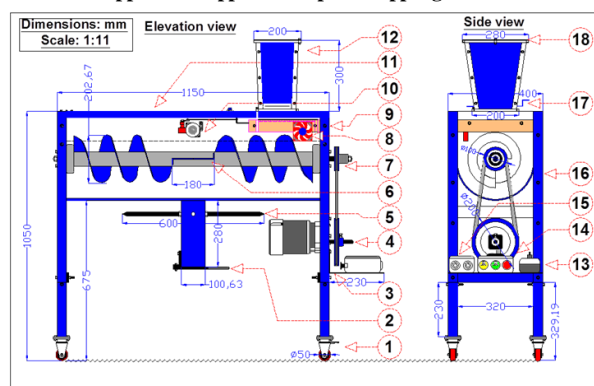

Fig. 2. The schematic drawing of the developed electro-sterilization grain device:

- 1- Solid wheels (50 mm, Dia.).
- 2- Grains gate.
- 3- Side holder.
- 4- Auger AC motor (pulley 200 mm).
- 5- Sacks holder.
- 6- Grains collecting bat.
- 7- Auger pulley (100 mm).
- 8- DC fan.
- 9- Grains sieve.
- 10- DC reciprocating motor.
- 11- Upper grains door.
- 12- Hopper.
- 13- AC motor switch.
- 14- Electrocution controller.
- 15- DC controller.
- 16- Auger housing.
- 17- Grains slider controller.
- 18- Hopper shut cap.

1- Power source (AC electrical motor)

A two-phase electric motor running on 220 V of alternating current was used as the main power source (Fig. 1, a and Fig. 2, No. 4). The technical specifications of the electric motor are listed in (Table 2). The electric motor is equipped with a decelerator type gearbox that has a reduced rotational speed ratio of (1:16). The built-in gearbox had a powerful rotating torque to reduce the slippage rate during operation. The motor is installed lower between the front legs of the chassis on a slider to control the tension of the running belt (1075 × 17 mm) of the thermal type as shown in (Fig. 1, b).

2- Grain conveyor auger

The grain auger is of the middle bat conveying type with the following specifications (length: 1000 mm; flight diameter: 200 mm; shaft diameter: 60 mm and auger pitch: 125 mm), as shown in (Fig.2, No. 6). It consists of two opposite halves, with a rectangular bat in between (180 × 120 mm), to collect the grains in the middle. The auger directs the grain directly into the bottom packing tube. This type was chosen so as not to damage the grains when they are electrically treated as shown in (Fig. 5, No.11). The auger is secured by a pair of bearing flanges at both ends and connected to three 12 mm bolts to the chassis.

3- The auger housing

As shown in (Fig.2, No.16), the auger housing was made in the form of a half-cylinder of galvanized sheet with a thickness of 1 mm. The auger housing is coated with an electrically insulating paint to avoid electrical hazards. The auger housing is streamlined to ensure that the grains slide as they are directed to the grain tube. A clearance of 20 mm was used between the auger and the housing to ensure that the treated grains were not rubbed to minimize mechanical frictional damage. The auger housing was supported on both sides by two formed iron arcs with dimensions of (radius: 190 mm Dia.; thickness: 10 mm and width: 40 mm), to bear the weight of the grains.

4- Grains hopper

The grain hopper was made in the form of an inverted and beveled quadrilateral pyramid, as shown geometrically in (Fig. 2, No. 12). The hopper is provided from below with a lateral side control slider to control the flow of grains (feed rate) as shown in (Fig.2, No. 17). The side control slider had the dimensions of (length: 200 mm; width: 120 mm, and thickness: 1 mm). This controller was provided with a manual handle for tensile. The grain hopper can accommodate up to 6 kilograms at a time. The hopper was sealed using an upper shut cap to ensure safety during operation (Fig. 2, No. 18).



Fig. 3. The grains path through sterilization.

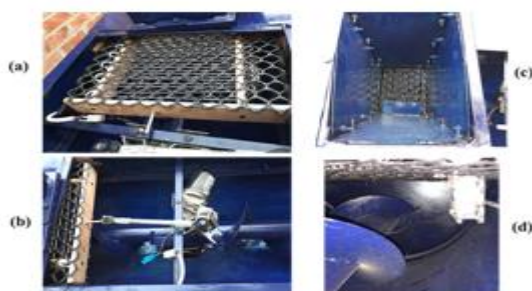

Fig. 4. Device parts; (a) The grains sieve; (b) the sieve motor installation; (c) hopper inside view and (d) the inside view of sieve fan.

5- Electrocutting sterilization unit

This unit consists of a reciprocating sieve with a network of transverse iron bars with a diameter of 1.5 mm and a length of 200 mm (Fig.4, a). The electrocutting element had 24 iron rods that were connected alternately to the electric field in the arrangement of a cathode and anode, as shown in (Fig. 5, No.3). The electrodes were distributed into 12 positive ones interspersed with 12 negative electrodes with a clearance between each electrode of 20 mm to suit small to medium grains (Fig. 7). The grain electrical reciprocating sieve is formed from the following parts, as shown in (Fig. 5).

A. Sieve wooden chassis: The internal chassis of the reciprocating electric sieve was made of beech wood, with a thickness of 20 mm and a height of 60 mm (Fig. 5, No.1). The wooden sieve chassis was perforated to install the electrocutting rods. Also, the terminals of each electrode were insulated using a thermo rubber-shrink wrap to avoid electrical hazards.

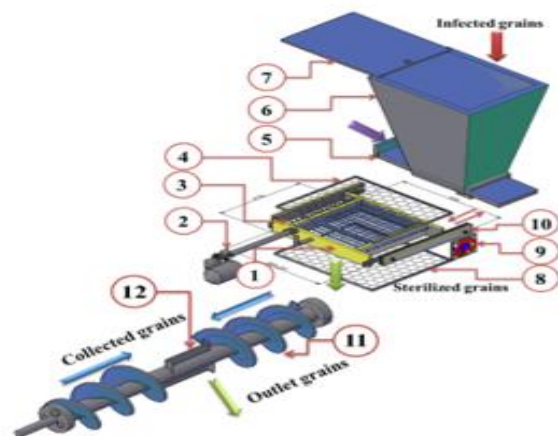

Fig. 5. Isometric drawing for the inlet electro-sterilization device components

1- Wooden grains sieve. 2- Reciprocating motor connecting rod. 3- Electrocutting rods (2.5 mm Dia., 200 mm Length). 4- Upper hexagonal grain mesh. 5- Grains slider controller. 6- Hopper. 7- Hopper shut cap (280×200 mm). 8- Lower hexagonal grain mesh. 9- DC fan. 10- Sieve lateral sliders. 11- Grains auger. 1- Grains collecting bat.

B. Hexagonal perforated plastic sheets: Two hexagonal perforated plastic sheets were installed on both the upper and lower sides of the sieve as shown in (Fig.5, No. 4 & 8) with an average holes diameter of 32 mm. These sheets were installed to mainly insulate the device from electrical leakage and shortcuts.

C. Lateral sliders: The sieve is attached to the device's metal chassis using two telescopic sliders with a length of 350 mm. Each slider contains a small ball bearing distributed longitudinally inside a movable guide of the same length to reciprocate movement of the sieve left and right (Fig. 5, No. 10). Each telescopic slide is also equipped with a rubber stopper to control the length of the sieve stroke.

D. DC Fan: A small DC fan (12 V & 1.5 A) with a square chassis (40 × 40 mm) is installed under the sieve during its movement (Fig.5, No. 9). The fan had 7 blades with a rotational speed of up to 1550 RPM. The fan displaces insects that have been eliminated during the treatment. The fan also cools the grains during treatment to ensure

the quality of germination. Four blue LED bulbs that attract insects are installed in the fan. A flexible insulated connecting wires attached to the sieve and fan electrical circuits were used (Fig.4, d).

E. DC reciprocating motor: As shown in (Fig. 4, b), a two-speed 12-V DC reciprocating motor was used to transmit the reciprocating movement to the electrical grain sieve. The specifications of the reciprocating motor are listed in (Table 2). The motor moves the sieve reciprocally at two different speeds through a rod (250 mm length and 15 mm diameter) connected to an adjustable threaded iron hook installed on the sieve (Fig. 5, No.2).

6- Transmission system

The rotary movement is transmitted from the AC motor by means of a V-type pulley (200 mm in diameter and 17 mm in thickness) to the pulley fixed on the auger shaft (100 mm in diameter and 17 mm in thickness) (Fig.2, No. 4 & 7). An electronic motor speed switch (Fig. 6, a, No.1) was used to control the rotational speeds of the motor as well as the auger, as listed in (Table. 3).

7- Grains packing tube

The grain packing tube is installed lower in the middle of the auger bat trough auger housing as shown in (Fig.1, No. 3). It is made of iron that is 4 inches in diameter, 10 mm thick and 250 mm long. A sliding gate is installed at the end of the packing tube to lock it in during operation (Fig. 2, No.2). A sack holder was also used, which is a tapered solid shaft on both ends, with a diameter of 10 mm and a length of 600 mm (Fig.2, No.5). The sack holder was installed transversely through the packing pipe for easy installation of sacks as shown in (Fig. 1 No.4).

8- Chassis

A strong chassis has been manufactured, taking into account all the loads and stresses during operation. As shown in (Fig. 1, a), a movable chassis was made on four small solid wheels with a diameter of 50 mm (Fig.2, No.1). A pair of wheels with brakes in the direction of the motor were used. The chassis was designed with a suitable height above the ground to fit the sacks' size of about 675 mm, as shown in the engineering drawing (Fig. 2). The chassis is divided into upper and lower halves. The upper part, which takes the shape of a cuboid, is fitted with a hinged door with a handle for easy maintenance operations (Fig. 1, b No.16). Also, the lower part contains a cylindrical auger housing. The device can accommodate a maximum load of about 100 to 150 kg depending on the density of the treated grain. The chassis is completely insulated and secured from electrical failure.

9- Electrical circuits

An integrated circuit has been designed to operate the electro-sterilization device, which is easy to operate and has a high degree of safety from electrocution hazards. The electrical circuits were divided into three main branches that were assembled and installed on the side of the device (Fig. 6, a). An electronic timer was used during the practical experiments, as shown in (Fig. 6, a, No.2). As illustrated in (Fig. 7), the operating circuits of the device consisted of the following.

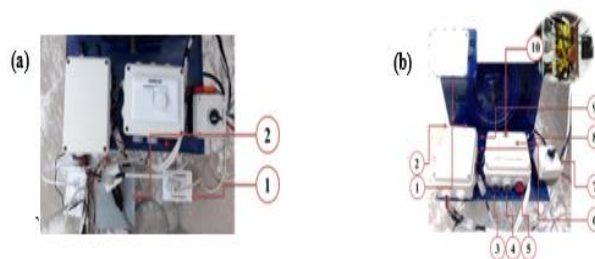

Fig. 6. The electrical control unit; (a) the electrical controllers (1. motor speed switch and 2. timer unit) and (b) the device operating switches:

- 1- Sieve motor two presses switch. 2- DC fan switch. 3- LED ampere indicator. 4- LED voltage indicator. 5- AC current indicator lamp. 6- Electrocutation dimmer. 7- AC motor control switch (stop- right-left). 8- Sieve indicator lamp. 9- Fan indicator lamp. 10- Electrocutation electronic board.

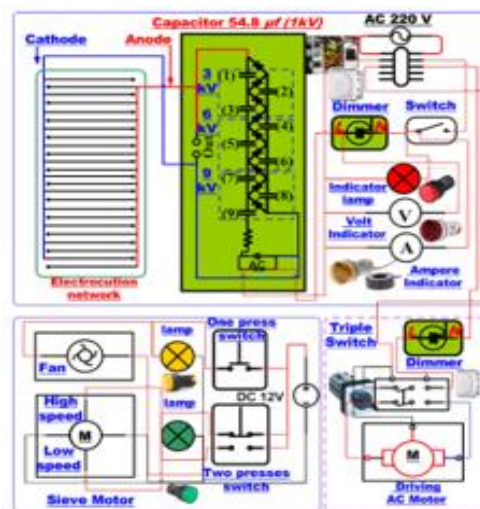

Fig. 7. The electro-sterilization device electrical circuits.

- (A) **The grains electrocution circuit: (220V AC):** It generates an electric field with a large voltage of up to 9000 volts, which is automatically discharged to directly eliminate any pest or insect inside the treated grain. The electrocution circuit contains nine large capacitors (54.8μf) whose output is assembled and unified by diodes. A ceramic thermal resistance (2 kΩ) was used to ensure the quality of operation for long periods (Fig. 6, b No.10). Each electrocution level operates (3, 6 or 9) capacitors through the use of a calibrated electric dimmer (Fig. 6, b No.6) connected to a LED voltage indicator connected to a direct switch (Fig. 6, b No.4). Also, an ampere sensor was connected to a digital LED ampere indicator that directly calculates the intensity of the electric current used for electrocution (Fig. 6, b No.3). The electrocution board and indicators were installed inside a single insulating box with a liquid seal gasket (Fig. 1, No. 9). A red indicator light has been inserted, indicating that the detonator circuit is on (Fig. 6, b No.5).
- (B) **The auger drive motor operating circuit: (220V AC):** This circuit directly controls the auger operating speeds (Fig. 7). The circuit contains a directional switch for the motor that turns the motor right and left and also stops it (Fig. 6, b No.7). The electric current is transmitted to the motor direction switch through a

speed switch calibrated to four operating speeds as shown in (Fig. 6, a No.1).

(C) The sieve motor and fan operating circuit (12V DC): This circuit operates both the sieve motors by means of a special switch with two presses (low and high speed) (Fig. 6, b No.1). This switch is connected to a green 12 V indicator light (Fig. 6, b No.8). This circuit also operates the fan inserted into the electric sieve through a switch connected to an orange indicator light (Fig. 6, b No.2 & 9). The circuit is fed by a transformer (12V-2A). An insulated box containing this circuit was also used (Fig. 2, No.15).

Experimental procedure

Experiments were carried out on wheat grain stored for one year in one of the warehouses of the Ministry of

Table 3. The electro-sterilization device tested factors levels.

Levels	AC motor speed, rpm	Driving motor pulley speed (200 mm Dia.)		Auger driven pulley speed (100 mm Dia.)	
		rpm	m/s	rpm	m/s
1	25	25	0.262	50	0.262
2	50	50	0.524	100	0.524
3	75	75	0.785	150	0.785
4	100	100	1.047	200	1.047

levels	DC reciprocating motor		Grains sieve speed	
	rpm	m/s	rpm	m/s
1	35	0.220	35	0.220
2	45	0.283	45	0.283

Measurements

1-The mortality percentage (sterilization efficiency), (M):

These percentages were determined according to (Schatzki and Fine,1988) after determining the rate of insect infestation for random samples for every experimental unit before and after sterilization treatment using the X-ray method. The insect infestation estimation method using the X-ray method was applied as shown in (Fig. 8). Using special units of X-rays are used to make pictures of grains weighing 100 g. These pictures show the presence of insects inside the grains, and they are considered the most accurate and fast methods. The mortality percentage was determined as listed in equation (1).

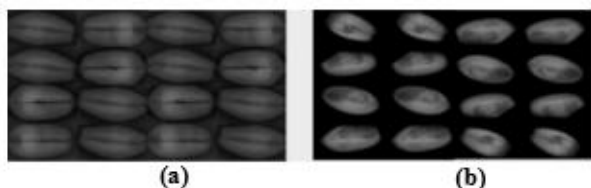

Fig. 8. The X-ray photo for random samples of wheat grains: (a) clean grains and (b) infected grains.

$$M = \frac{G2}{G1} \times 100\% \dots\dots\dots (1)$$

Where: M: the insect mortality percentage, %; G1: the grains symbol before sterilization insect infestation, insect/gm; G2: the grains symbol after sterilization, insect/gm.

2-Insect infestation emergence rate (Em): This percentage was determined after one month from the treatment using the X-ray method for the tested random treated samples. It was determined as illustrated in equation (2).

$$Em = \frac{N}{W} \times 100\% \dots\dots\dots (2)$$

Agriculture at the El_Serw Research Station. A Sakha 94 species with 15% humidity was used (the standard percentage is 11-13% but it was increased to encourage insect infestation). The experiments were conducted to test the following variables, as listed in (Table 3): First, four auger operating speeds (0.262, 0.524, 0.785 and 1.047 m/s). Second, there are three levels of electrocution (3000, 6000 and 9000 volts). Third, two speeds of the electrical grain sieve (0.220 and 0.283 m/s). Fourth, there are two feeding rates for grain (0.18 and 36 Mg/h). Three replicates were used and the experiment design was included in a four-way completely randomized factorial experiment. The statistical analysis was conducted using the Spss program with a probability of 5%.

Where: Em: the Insect infestation emergence rate, %; N: number of insects for sterilized grains after one month insect; W: the symbol weight 100 gm.

3-Germination percentage, (G): By taking random samples from the treated grains after and before the sterilization operation, placed in Petri dishes containing cotton layers soaked with tap water and covered with paper. The germination percentage was recorded after 4 days, according to (Paterson, 1989).

$$G = \frac{G}{Gt} \times 100\% \dots\dots\dots (3)$$

Where: G: germination percentage, %; G: germinated sterilized grains number; Gt: total grains symbol number.

4-The grain damage percentage, (D): It was assumed by equation (4) as followed.

$$D = \frac{Wd}{Wt} \times 100\% \dots\dots\dots (4)$$

Where: D: grain damage percentage, %; Wd: the damaged grains symbol weight, gm; Wt: total symbol weight, gm.

5-Grain weight loss percentage, (L): The losses of wheat grains were determined as dry weight after sieving and sterilization treatments using equation (5) according to (Harris and Lindblad, 1987).

$$L = \frac{W1 - W2}{W1} \times 100\% \dots\dots\dots (5)$$

Where: L: grains weight loss percentage, %; W1: grains weight before sterilization, gm; W2: grains weight after sterilization, gm.

6-The auger volumetric efficiency, (ηv): It was determined by (Srivastava *et al.*, 1993).

$$\eta_v = \frac{V_{ac}}{V_{th}} \times 100\% \dots\dots\dots (6)$$

Where: η_{th}: volumetric efficiency, %; V_{ac}: actual volume capacity, cm³/min; V_{th}: the theoretical volumetric capacity, cm³/min. (Notice: η_{th} ranged from 10.71 to 42.86 m³/h)

$$V_{th} = \frac{\pi}{4} [(d_{sf})^2 - (d_{ss})^2] I_p N\% \dots\dots\dots (7)$$

Where: V_{th} : the theoretical volumetric capacity, cm^3/min ; d_{sf} : auger flight diameter, cm ; d_{ss} : auger shaft diameter, cm ; I_p : pitch length, cm ; N : auger rotational speed, rpm .

7-Sterilization device productivity, (P): It was calculated using formula (8).

$$P = M_w / t \text{ (Mg/h)} \dots\dots\dots (8)$$

Where: P : device productivity, Mg/h ; M_w : sterilized grains weight, ton ; t : the time consumed in operation, h .

8-Specific energy consumption (SE): The electrical energy consumption (kW) was determined for each test by taking the readings of both line current and voltage using an ampere sensor indicator. Hence, the consumed electrical power (kW) for each treatment was estimated according to (Culpin, 1986) as follows:

$$Ep = I \cdot V \cdot \eta \cdot \cos\phi / 1000 \text{ (AC 220V) kW} \dots\dots (9)$$

$$P = V \cdot I / 1000 \text{ (DC 12V) kW} \dots\dots\dots (10)$$

$$EP_t = (Ep + P) \text{ kW} \dots\dots\dots (11)$$

Where: Ep = electrical consumed power under different machine loads; I : line current strength in A ; V : potential difference (V) being equal to ($220 V$ or $12 V$); η : mechanical efficiency (assumed as 80%); $\cos\phi$ = power factor (was taken as 0.7). P : DC consumed power, kW , Ep_t : total electrical consumed power, kW .

Consequently, the specific energy consumption ($kW.h/Mg$) for each treatment could be calculated using the following equation:

$$SE = \frac{\text{Consumed power (kW.h)}}{\text{Productivity (Mg/h)}} \text{ (kW.h/Mg)} \dots\dots (12)$$

9-The cost estimation (L.E/Mg): The device operating cost was determined as presented in equations (13) according to the methodology of (Hunt, 1983):

$$\text{Operating cost}(C) = \frac{\text{Device hourly cost, (L.E./h)}}{\text{Productivity, (Mg / h)}} \text{ (L.E / Mg)} \dots\dots\dots (13)$$

RESULTS AND DISCUSSION

First: Sterilization device performance evaluation

A- Grains insects mortality percentage (sterilization efficiency)

As shown in (Fig. 9, a), there is a direct and incremental proportional relationship between the tested linear speed levels of the grain auger (A) and the percentage of insect mortality (M) at different levels of electrocution (E). The highest percentage of insect mortality, i.e. sterilization efficiency, was about 95.42% for the highest level of electrocution ($9000 V$), as well as the highest speed of the auger ($1.047 m/s$). The lowest mortality rate for insects was 70.0% at the lowest level of electrocution ($3000 V$), as well as the lowest linear speed of the auger ($0.262 m/s$). Also, the results shown in (Fig. 9, b & c) showed a positive proportional direct relationship between the rates of electrocution (E) and the insect mortality rate (M) with both sieve linear speeds (S) and

grain feeding rates (F). The highest rates of (M) were (85.44 and 85.20%), respectively, at the maximum level of (E) $9000 V$, the highest sieve speed (S) $0.283 m/s$, and the lowest used feeding rate (F) $0.18 Mg/h$. Besides, the minimum values of (M) were (80.28 and 80.55%) recorded at the minimal level of (E) $3000 V$, the lowest sieve speed (S) $0.220 m/s$, and the highest level of (F) $0.36 Mg/h$.

The high percentage of insect mortality for stored grains is due to the use of direct electrocution technology without affecting the quality of the grains. The efficiency of the electric grain sterilizer exceeded the efficiency of any chemical sterilization method as a result of the development of the electronic circuits of the device. The higher the rate of the large electrocution voltage difference coming out of the device, the higher the percentage of insect extermination. Also, the increase in the speed of the auger with the increase in the speed of the sieve and the reduction in the feeding rate led to a significant direct increase in the rate of mortality. Debnth *et al.*, (2011) demonstrated that exposing insects to the electric field leads to loss of moisture in them and kills them. Also, (Madrid *et al.*, 1990) found that adults and larvae feed on stored grains of corn, rice, barley, and oats, and cause huge economic losses and deterioration in their quality.

B- The insect infestation emergence rates

Also, as shown in (Fig. 10, a), there is a synchronized relevant proportional inverse relationship between both linear speeds for augers and the insect infestation emergence rates (E_m) at the various levels of electrocution. As the auger speed and the electrocution levels increased, they relatively decreased the insect infestation emergence rates (E_m) and vice versa. It is clear that the highest value of (E_m) after the treatment of electrosterilization has not exceeded 11.76% at the minimal levels of both (A & E) respectively. Moreover, the lowest value of (E_m) was 1.06% using the maximal levels of both auger linear speeds and electrocutions. Also, as presented in (Fig. 10, b & c), the relationships between (E) and (E_m) at the different levels of (S & F) followed transverse proportional relationships. The average recorded lowest values of (E_m) were indices between (4.90 and 5.06%) respectively that gained the highest value (E) and the least value (F). The highest values of (E_m) were (7.18 and 7.09%) respectively at the minimal level of (E) and vice versa at the maximal level of (F).

The results showed a significant decrease in the frequency of insect infestation as a result of using high levels of voltage at appropriate speeds for the auger and grain sieve. The low rates of insect infestations are due to the elimination of all insect eggs, as the electrical treatment is characterized by eliminating any living creature with moisture content. The results are in agreement with (Li *et al.*, 2019) which studied the electrical effect of corn seeds and found that adults, larvae or eggs are subjected to fatal heat stress that leads to their non-emergence.

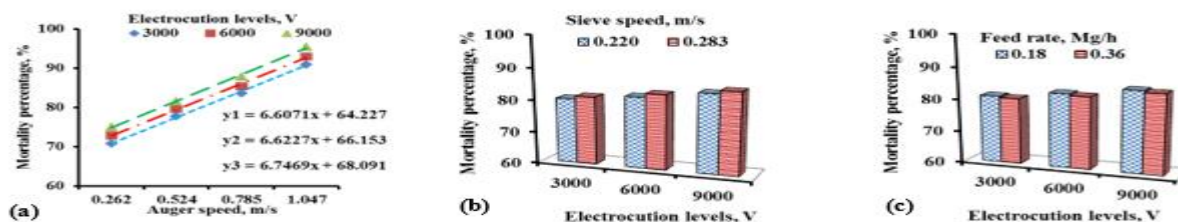

Fig. 9. The effect of auger speed levels on the mortality percentages at various (a) electrocution levels, (b) sieve speeds, and (c) feed rates.

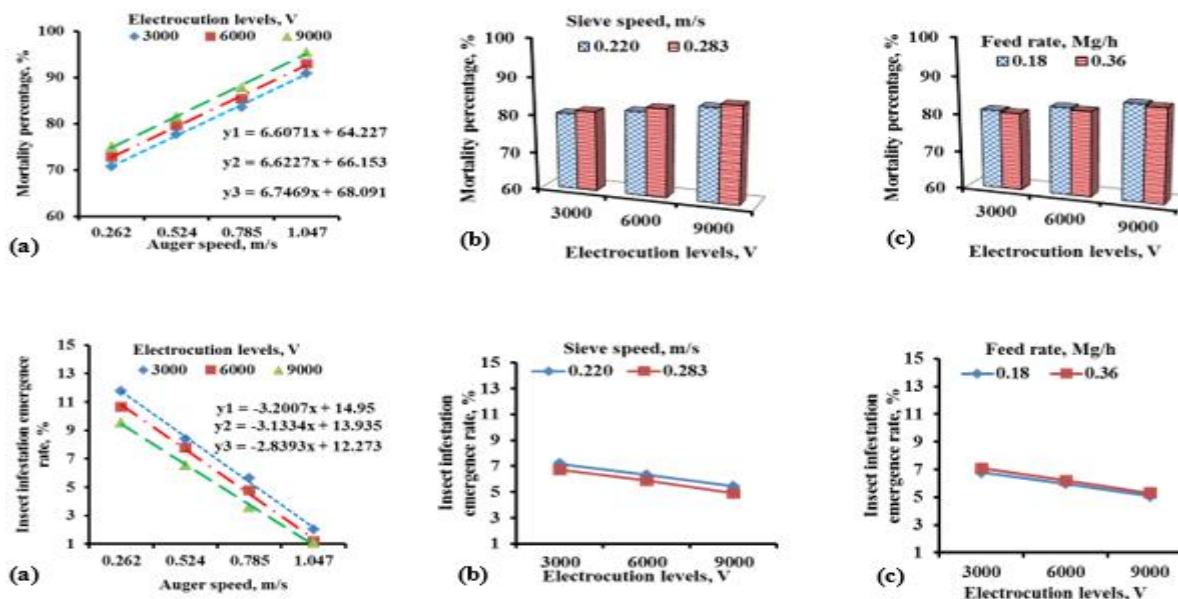

Fig. 10. The effect of auger speed levels on the insect infestation emergence rates at various (a) electrocution levels, (b) sieve speeds, and (c) feed rates.

As well, (Table 4) showed the probability significance using ANOVA tests for all the measurements. Statistically, the stepwise regression analysis formulas were estimated using the Spss program to identify the most effective variables for the insect mortality percentages (M)

and the insect infestation emergence rates (Em) as followed (Equations 14 & 15).

$$(M), \% = 57.833 + 25.455 A + 0.001 E + 16.249 S .. (14)$$

$$(Em), \% = 17.053 - 11.689 A - 7.632 S + 1.352 F..... (15)$$

Table 4. The statistical ANOVA analysis for the tested variables.

Variables	M, %	Em, %	G, %	D, %	L, %	ηv, %	P, Mg/h	SE, kW.h/Mg	C, L.E/Mg
A, m/s	0.0***	0.0***	0.0***	0.0***	0.0***	0.0***	0.0***	0.0***	0.0***
E, V	0.0***	0.0***	0.0***	0.0***	0.0***	0.0***	0.0***	0.0***	0.0***
S m/s	0.0***	0.0***	0.0***	0.01**	0.0***	0.0***	0.0***	0.0***	0.0***
F, Mg/h	0.0***	0.0***	0.0***	0.0***	0.0***	0.0***	0.0***	0.0***	0.0***
Interaction									
A×E	0.0***	0.0***	0.0***	0.0***	0.0***	0.0***	0.0***	0.0***	0.0***
E×S	0.0036**	ns	0.0***	ns	0.0***	ns	0.0***	0.0***	0.0***
E×F	ns	ns	0.001**	ns	0.0072**	ns	ns	ns	ns
R ²	0.8995	0.8993	0.8996	0.7670	0.8995	0.7996	0.8993	0.8993	0.8996
C.V	0.233	1.873	0.116	8.090	1.082	0.163	0.209	0.210	0.171

Where: A: auger linear speeds, m/s; E: electrocution levels, V; S: sieve linear speeds, m/s; F: grains feed rates, Mg/h; M: mortality percentages, %; Em: emergence rates, %; G: germination percentages, %; D: damage percentages, %; L: weight loss, %; ηv: auger volumetric efficiency, %; P: device productivity, Mg/h; SE: specific energy consumption, kW.h/Mg; C: operating costs; 0.0*** high significance at (p < 0.05) and ns: non-significant.

Second: Grains quality

A- Germination percentages

Germination tests are considered one of the most important indicators for assessing the quality of grain treated by electrocution to eliminate insects and perform the grain sterilization process. Clearly, as shown in (Fig. 11, a), there is a direct proportional linear relationship between the grain auger linear speeds (A) and the wheat grain germination percentages (G) at different levels of electrocution (E). The highest percentage of (G) was about 94.11% for the highest level of (E) of 9000 V, as well as the highest linear speed (A) of 1.047 m/s. The minimum germination percentage was 80.58% at the lowest level of 3000 V (E) and the lowest level of (A) (0,262 m/s). Also, (Fig. 11, b & c) presented direct relationships between (E) and (G) with both sieve linear speeds (S) and grain feeding rates (F). The maximum percentages of (G) were (88.69 and 88.58%), respectively, at the maximal level of (E) 9000 V, the highest sieve speed (S) 0.283 m/s, and the

lowest used feeding rate (F) 0.18 Mg/h. On the other hand, the minimum values of (G) were (86.01 and 86.20%) recorded at the minimal level of (E) 3000 V, the lowest sieve speed (S) 0.220 m/s, and the maximal level of (F) 0.36 Mg/h.

It is clear that the germination rates of the tested grains increased due to the effectiveness of the electrosterilization device, not only in eliminating insects but also in improving the quality of germination. The high germination rate is due to the positive effect of the electric field on activating the grains and improving their physiological properties. However, (Dannehl, 2018 and Sukhov *et al.*, 2019) studied the positive effect of electric fields on some crops and fruits on activating metabolic processes inside grains and thus increasing germination rate due to increases in ATP content in the treated seeds. Also, (Li *et al.*, 2019) showed a significant increase in the germination rate of maize as a result of exposure to an electric field for only 10 minutes.

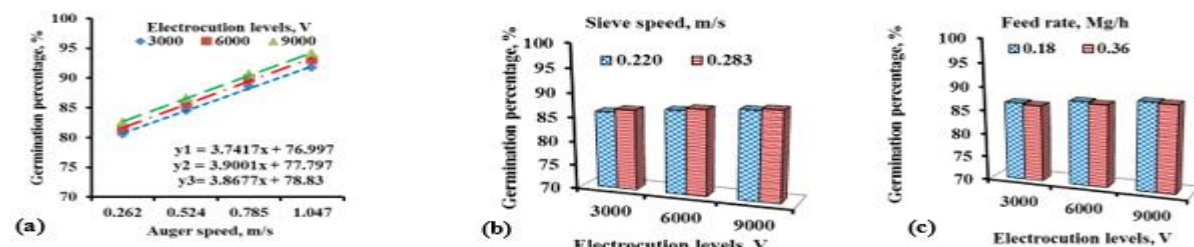

Fig. 11. The effect of auger speed levels on the germination percentages at various (a) electrocution levels, (b) sieve speeds, and (c) feed rates.

B- Grains damage percentage and weight loss

The estimation of the percentage of mechanical damage as a result of grain handling and processing is one of the indicators in the evaluation of grain quality tests. However, the estimation of the relative decrease rates in the weight of electrically sterilized grains is also considered as a strong indication of eliminating insects and improving grain quality. The results illustrated a direct logarithmic and linear proportional relationship between the auger linear speeds (A) and the grain damage and weight loss percentages respectively (D and L) at various levels of (E) (Fig. 12 & 13, a). The highest percentages of (D and L) were about (5.13 and 4.43%) for the maximum level of (E) 9000 V, and the highest (A) level of 1.047 m/s.

The lowest values of (D and L) were (1.23 and 1.08%) recorded at the lowest level of (A) (3000 V), as well as the lowest level of (A) 0,262 m/s. Consequently, the results shown in (Fig. 12 and 13, b & c) illustrated proportional direct relationships between (E) and (D and L) respectively with both parameters (S and F). The maximal rates of (D and L) were (3.81, 3.73, 3.05, and 3.02%), respectively, at the maximum level of (E) 9000 V, the highest sieve speed (S) 0.283 m/s, and the lowest used feeding rate (F) 0.18 Mg/h. Also, the minimal values of (D and L) were (3.03, 3.05, 2.37, and 2.40%) recorded at the minimal level of (E) 3000 V, the lowest sieve speed (S) 0.220 m/s, and the maximal level of (F) 0.36 Mg/h.

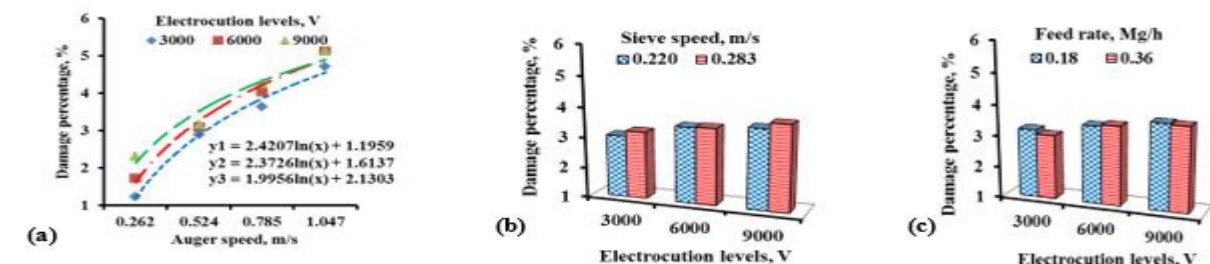

Fig. 12. The effect of auger speed levels on the grains damage percentages at various (a) electrocution levels, (b) sieve speeds, and (c) feed rates.

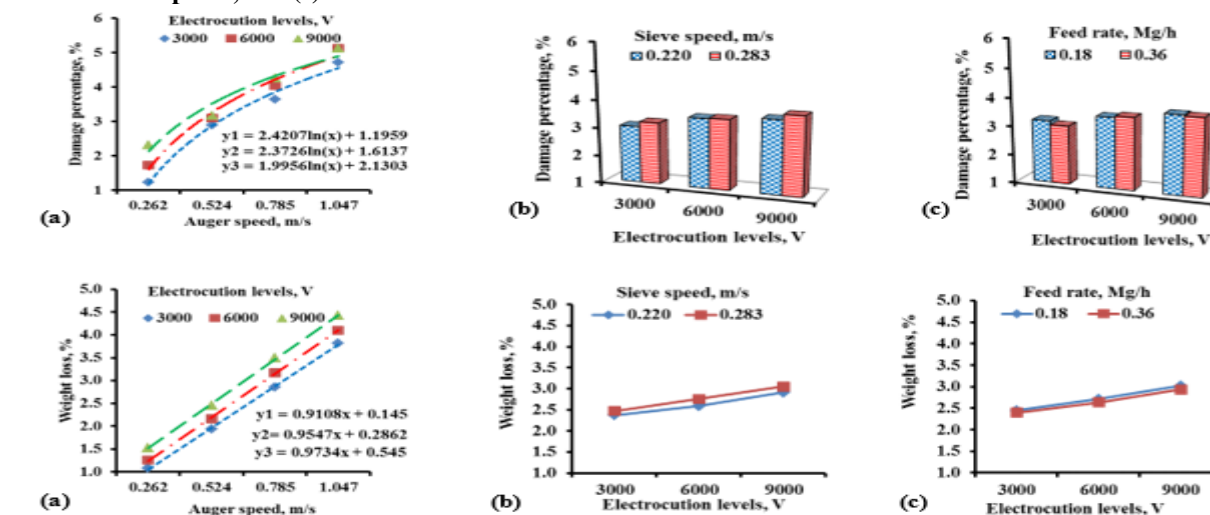

Fig. 13. The effect of auger speed levels on the grains weight loss at various (a) electrocution levels, (b) sieve speeds, and (c) feed rates.

The results show good indications of the reduction in spoilage of treated grains compared to the reduction in their weight. In some cases, the advanced insect infestation may destroy nearly half of the grain stock, in addition to the toxic effect, and the damage rates may reach 90%. The presence of a damage rate is due to the presence of some

friction between the severely infested insect seeds and the auger during treatment. The decrease in weight is also due to the effect of the moisture content decrement of the grains by a negligible percentage, which affects only insects and their eggs. The results of the study agreed with the results obtained by Strelec *et al.*, (2012).

Statistically, as presented in (Table 4), the significant probability measured values were gained using ANOVA tests to limit precisely the perfect device setting according to the best scored results. The stepwise regression formulas for the measured (G, D, and L) percentages were estimated as presented in equations (16, 17 & 18).

(G), % = 73.966 + 14.665 A + 8.501 S - 1.426 F (16)

(D), % = -0.318 + 4.054 A + (9.95×1⁻⁵) E + 2.037 S..... (17)

(L), % = -0.662 + 3.617 A + (9.274×1⁻⁵) E + 2.136 S - 0.04 F..... (18)

Third: Mechanical performance

A- Auger volumetric efficiency

The theoretical capacitance of the auger was calculated and compared with the actual capacitance under different operating conditions. The actual volumetric efficiency of the auger was practically measured to make an accurate mechanical specification for the electro-sterilization device. Obviously, (Fig. 14, a) illustrated a direct proportional linear relationship between (A) and the auger volumetric capacity (η_v) at different levels of electrocution (E). The maximum value of (η_v) was about 93.36% for the highest level of (E) of 9000 V, and the maximum linear speed (A) of 1.047 m/s. The minimum percentage of (η_v) was 75.71% recorded at the lowest level of 3000 V (E) and the lowest level of (A) (0,262 m/s).

Whereas, (Fig. 14, b & c) show direct relationships between (E) and (η_v) with both factor levels (S and F) respectively. The maximal percentages of (η_v) were (86.72 and 86.57%), respectively, at the highest level of (E) 9000 V, the highest level of (S) 0.283 m/s, and the minimal feed

rate (F) 0.18 Mg/h. Besides, the minimum values of (η_v) were (82.75 and 82.90%) determined at the lowest levels of both (E and S) with the maximum level of (F) 0.36 Mg/h.

B- Specific energy consumption

Estimating specific energy consumption rates, especially when developing any agricultural machine, is one of the most important design principles. The ampere measurement sensor attached to the device was used to give an accurate description of the electrical energy consumption rates. The specific energy consumption rates were more rational than any conventional control method in terms of operating cost. (Fig. 15, a) illustrates a proportional inverse logarithmic relationship between (A) and the specific energy consumption (SE) at different levels of electrocution (E). The highest value of (SE) was about 1.98 kW.h/Mg for the lowest level of (E) of 3000 V, and the minimal value of (A) was 0.262 m/s. The lowest value of (SE) was 1.60 kW.h/Mg recorded at the maximum level of (E) 9000 V and the highest level of (A) (1.047 m/s). Also, (Fig. 15, b & c) shows opposite relationships between (E) and (SE) with both variables levels (S and F) respectively. The maximal values of (SE) were (1.82 and 1.81 kW.h/Mg), respectively, at the lowest level of (E) 3000 V, the minimum level of (S) 0.220 m/s, and the highest level of (F) 0. 36 Mg/h. As well, the minimum values of (SE) were (1.73 and 1.73 kW.h/Mg) respectively, determined at the highest levels of both (E and S) with the minimal level of (F) 0.18 Mg/h.

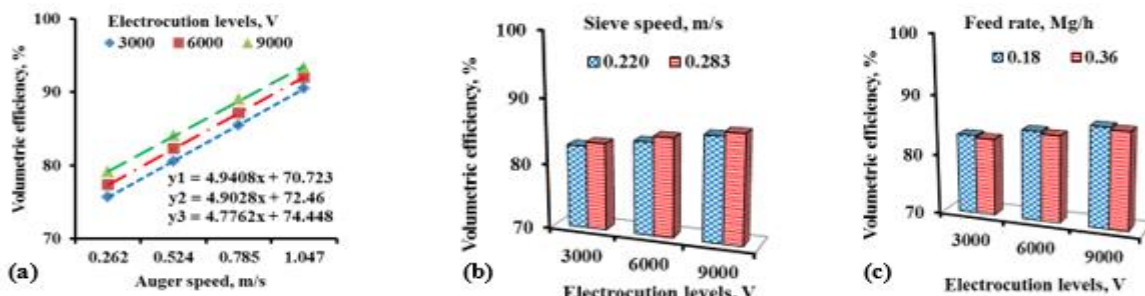

Fig. 14. The effect of auger speed levels on the auger volumetric efficiency at various (a) electrocution levels, (b) sieve speeds, and (c) feed rates.

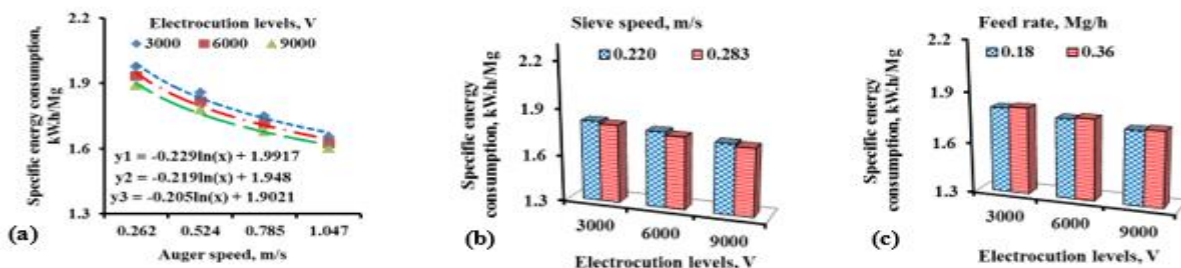

Fig. 15. The effect of auger speed levels on the specific energy consumption at various (a) electrocution levels, (b) sieve speeds, and (c) feed rates.

The results showed a decrease in the specific electrical energy consumed during the operation of the electro-sterilization device. The higher the linear speed of the agitators, the lower the specific energy consumption rates as a result of the short time required and thus reducing the rate of electrical energy consumption. In addition to the high mechanical efficiency of the component parts of the device, it reduced energy consumption rates as a result of

reducing friction and slipping in the transmission system with the agreement of design principles of agaric-machines (Srivastava *et al.*, 1993).

The probability significance using ANOVA tests for values of (η_v and SE) is listed in (Table 4). Statistically, the stepwise regression formulas (Equations 19 & 20) were as followed.

$$(\eta v), \% = 66.208 + 18.629 A + 0.001 E + 11.982 S \dots \dots \dots (19)$$

$$(SE), \text{kW.h/Mg} = 2.153 - 0.391 A - (1.174 \times 10^{-5}) E - 0.265 S + 0.051 F \dots \dots \dots (20)$$

Fourth: Economic Evaluation

A- The electro-sterilization device productivity

The productivity of the device was measured on the basis of the maximum operating rate per hour after calculating the time involved in maintenance and feeding the grain. Where the developed device achieves appropriate levels of productivity, it can be adopted as a productive device for the treatment of stored grains. The sterilization device productivity (P) has a direct and incremental proportional relationship between the tested factors (A and E), as shown in (Fig. 16, a). The maximum

value of (P) was about 0.252 Mg/h for the highest level of electrocution (9000 V), with the highest speed of the auger (1.047 m/s). Also, the minimum value of (P) was 0.204 Mg/h at the lowest level of (E) 3000 V, with the lowest level of (A) (0,262 m/s). Likewise, the relationships between (P) and the levels of (S and F) had the same positive direct trend, as shown in (Fig. 16, b & c). The highest values of (P) were (0.234 and 0.234 Mg/h), respectively, at the maximum level of (E) 9000 V, the highest level of (S) 0.283 m/s, and the lowest rate of (F) 0.18 Mg/h. However, the minimum values of (P) were (0.223 and 0.224 Mg/h) recorded at the minimal level of (E) 3000 V, and (0.220 m/s & 0.36 Mg/h) respectively for the factor levels of (S and F).

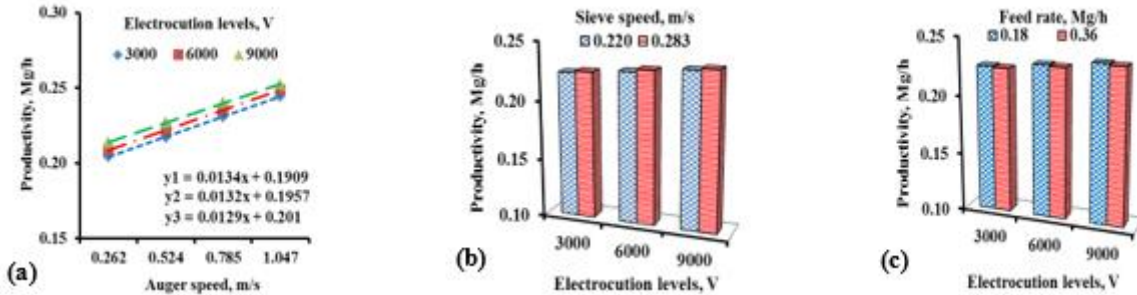

Fig. 16. The effect of auger speed levels on the sterilization device productivity at various (a) electrocution levels, (b) sieve speeds, and (c) feed rates.

B- The operating costs

The operating cost was estimated based on the current price of the electrical energy used, in addition to the addition of periodic maintenance costs and the capital recovery rate within three years. The device was manufactured locally and cost about 9 thousand pounds.

The device operating cost (C) had an opposite logarithmic proportional relationship between it and the tested factors (A and E), as shown in (Fig. 17, a). The maximal value of (C) was about 171.23 L.E/Mg for the lowest level of (E) 3000 V, and the lowest level of (A) 0.262 m/s. As well, the minimal value of (C) was 138.85 L.E/Mg at the highest level of (E) 9000 V, with the highest level of (A) (1.047 m/s). Also, the relationships between (C) and the levels of (S and F) had the same opposite trend, as shown in (Fig. 17, b & c). The highest values of (C) were (157.37 and 157.07 L.E/Mg), respectively, at the lowest levels of (E & S), with the maximum rate of (F) 0.36 Mg/h. Furthermore, the minimal values of (C) were (150.05 and 150.30 L.E/Mg) determined at the maximum levels of (E & S) with the lowest level of (F). Statistically,

the total interactions between different treatments had a highly significant effect ($P < 0.05$) on (C). Furthermore, ANOVA analysis indicated significant differences between the treatments as listed in (Table 4). The stepwise regression equations (21 & 22) for the measured (P and C) were determined as followed.

$$(P), \text{Mg/h} = 0.179 + 0.050 A + (1.493 \times 10^{-6}) E + 0.031 S \dots \dots (21)$$

$$(C), \text{L.E/Mg} = 186.514 - 339.38 A - 0.001 E - 22.099 S + 3.833 \dots \dots (22)$$

The operating cost of the device ranges from about 35 pounds per hour, which is considered very economical compared to any other method of sterilization. The results showed a significant increase in the used treatments and their positive impact on reducing operating costs for the unit of weight used. The higher the operating speeds with the levels of electrocution, the lower the operating costs due to the increased productivity. The cost of treating a ton of stored grain when it is infected and treated by chemical fumigation methods may reach expensive amounts that are more than ten times the cost of treating grains by the developed electrical method.

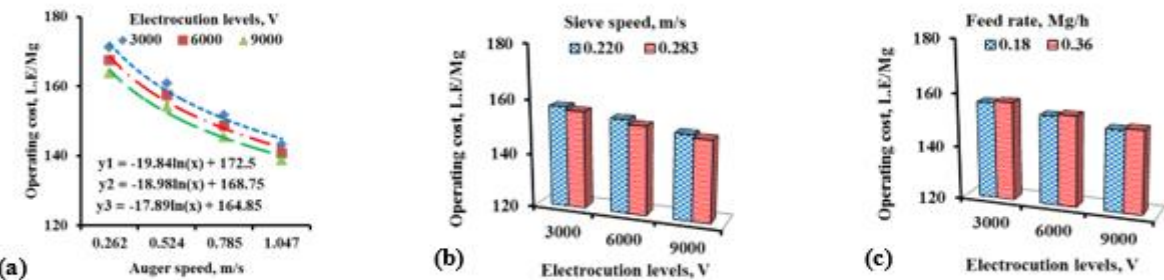

Fig. 17. The effect of auger speed levels on the operating costs at various (a) electrocution levels, (b) sieve speeds, and (c) feed rates.

CONCLUSION

The most important results for operating experiments of the developed stored grain electro-sterilization device are summarized in the following important points. First, the percentage of insect mortality increased to more than 95%. Also, the emergence rates of insect infestation reduced to 11.76% only after 1 month. The best device performance was with using optimum levels of the tested variables for speed of the auger (1.047 m/s) and grain sieve (0.282 m/s) with the highest electrocution (9000 V) while reducing the grain feeding rate (0.18 Mg/h). Secondly, the germination rate increased to more than 94%. Also, the percentage of mechanical damage and weight loss decreased to 5.13 and 4.43% respectively. Third, the measured actual volumetric efficiency of the auger increased to 93.36%. The productivity of the device reached 0.252 Mg/h. Fourth, the specific energy consumption rates decreased to 1.98 kW.h/Mg at the optimum operating costs (171.23 L.E/Mg). Therefore, it is recommended the adoption of this developed device, its manufacture, and its inclusion in grain stores and silos at the level of the republic to advance the agricultural sector in Egypt.

REFERENCES

- Ahmed, Z., Manzoor, M. F., Begum, N., Khan, A., Shah, I., Farooq, U. and Siddeeg, A. (2019). Thermo-ultrasound-based sterilization approach for the quality improvement of wheat plantlets Juice. *Processes*, 7(8), 518.
- Andric, G., Golic, M. P. and Kljajic, P. (2015): Toxicity of several contact insecticides to *Tribolium castaneum* (Herbst) populations afteselection with pirimiphos-methyl and deltamethrin. *Pestic. Phytomed. (Belgrade)*, 30(4): 209–216.
- Atanda, S. A., Pessu, P. O., Agoda, S., Isong, I. U., Adekalu, O. A., Echendu, M. A. and Falade, T. C. (2011). Fungi and mycotoxins in stored foods. *African Journal of Microbiological Research* 5 (25): 4373-4382.
- Chinnamuthu, C. R. and Boopathi, P. M. (2009). Nanotechnology and agroecosystem. *Madras Agricultural Journal*, 96(1/6), 17-31.
- Culpin, C. (1986). *Farm Machinery- The English Language*. Book Society. Collins (11th ed.): 276-285.
- Dannehl, D. (2018). Effects of electricity on plant responses. *Sci Hort.* 234:382–392.
- Debnath, N., Das, S., Seth, D., Chandra, R., Bhattacharya, S. C. and Goswami, A. (2011). Entomotoxic effect of silica nanoparticles against *Sitophilus oryzae* (L.). *Journal of Pest Science*, 84(1), 99-105.
- Dubale, B., Waktole, S., Solomon, A., Geremew, B. and Sethu, M. R. (2012). Influence of agro-ecologies, traditional storage containers and major insect pests on stored maize (*Zea mays* L.) in selected woredas of Jimma zone. *Asian Journal of Plant Sciences*, 11(5), 226-234.
- El-Aziz, S. A. (2011). Control strategies of stored product pests. *Journal of entomology*, 8(2), 101-122.
- Fang, L., Subramanyam, B. and Arthur, F. H. (2002). Effectiveness of spinosad on four classes of wheat against five stored-product insects. *Journal of Economic Entomology*, 95(3), 640-650.
- FAOSTAT (2021). Production of Wheat in World. <http://www.fao.org>.
- Fields, P. G. (2006). Effect of *Pisum sativum* fractions on the mortality and progeny production of nine stored-grain beetles. *Journal of Stored Products Research*, 42(1), 86-96.
- Gamal, M. M. Z. (2018). Nano-particles: a recent approach for controlling stored grain insect pests. *Academia Journal of Agricultural Research*, 6(5 Conference Proceedings), 88-94.
- Harris, K. L. and Lindblad, C. J. (1978). Post-harvest grain loss assessment methods. Minnesota, America Association of Cereal Chemist, 193.
- Hidaka, Y. and Kubota, K. (2006). Study on the Sterilization of Grain Surface Using UV Radiation—Development and Evaluation of UV Irradiation Equipment—. *Japan Agricultural Research Quarterly: JARQ*, 40(2), 157-161.
- Hunt, D. (1983). *Farm Power Machinery Management*. 8th ed. Ames: Iowa State University Press.
- Ignatowicz, S. (2004). Irradiation as an alternative to methyl bromide fumigation of agricultural commodities infested with quarantine stored product pests. Irradiation as a phytosanitary treatment of food and agricultural commodities, 51-66.
- Kumar, S., Mohapatra, D., Kotwaliwale, N. and Singh, K. K. (2017). Vacuum hermetic fumigation: A review. *Journal of stored products research*, 71, 47-56.
- Li, Z. G., Gou, H. Q. and Li, R. Q. (2019). Electrical stimulation boosts seed germination, seedling growth, and thermotolerance improvement in maize (*Zea mays* L.). *Plant signaling & behavior*, 14(12), 1681101.
- Madrid, F. J., White, N. D. G. and Loschiavo, S. R. (1990). Insects in stored cereals, and their association with farming practices in southern manitoba. *The Canadian Entomologist*, 122(3), 515-523.
- Mahroof, R. M., Hagstrum, D. W., Phillips, T. and Cuperus, G. W. (2012). Biology, behavior, and ecology of insects in processed commodities. *Stored Product Protection*; Hagstrum, DW, Phillips, TW, Cuperus, G., Eds, 33-44.
- Paterson, A. H., Sorrells, M. E. and Obendorf, R. L. (1989). Methods of evaluation for preharvest sprouting resistance in wheat breeding programs. *Canadian Journal of Plant Science*, 69(3), 681-689.
- Rajendran, S. and Sriranjini, V. (2008). Plant products as fumigants for stored-product insect control. *Journal of stored products Research*, 44(2), 126-135.
- Salem, S. A., Abou-Ela, R. G., Matter, M. M., and El-Kholy, M. Y. (2007). Entomocidal effect of *Brassica napus* extracts on two store pests, *Sitophilus oryzae* (L.) and *Rhizopertha dominica* (Fab.)(Coleoptera). *J. Appl. Sci. Res*, 3(4), 317-322.

- Santavec, I., and Acko, D. (2011). Impact of fungicides and other preparations for seed treatment and different cultivation techniques on seed contamination of winter wheat (*Triticum aestivum* L. emend. Fiori et Paol.). *Acta agriculturae Slovenica*, 97(3), 267.
- Schatzki, T. F. and Fine, T. A. (1988). Analysis of radiogram of wheat kernels for quality control. *Cereal Chemistry*, 65(3), 233–239.
- Semple, R. L. (1992). Post-harvest technology: Storage development and application in developing Asian countries. *Grain Storage Systems in Selected Asian Countries*. REAPASIA. People Republic of China, 9-59.
- Srivastava, A. K., Goering, C. E., Rohrbach, R. P. and Buckmaster, D. R. (1993). *Engineering principles of agricultural machines*. ASAE Textbook, No (5), Published by American Society of Agricultural Eng.
- Strelec, I., Kučko, L., Roknić, D., Mrša, V. and Ugarčić-Hardi, Ž. (2012). Spectrofluorimetric, spectrophotometric and chemometric analysis of wheat grains infested by *Sitophilus granarius*. *Journal of stored products research*, 50, 42-48.
- Williams, J. H., Phillips, T. D., Jolly, P. E., Stiles, J. K., Jolly, C. M. and Aggarwal, D. (2004). Human aflatoxicosis in developing countries: a review of toxicology, exposure, potential health consequences, and interventions. *The American journal of clinical nutrition*, 80(5), 1106-1122.

تطوير جهاز تعقيم كهربائي للحبوب المخزنة.

أحمد شوقي السيد السيد و سحر السيد أحمد موسى

معهد بحوث الهندسة الزراعية- مركز البحوث الزراعية- مصر.

تهدف هذه الدراسة إلى تطوير وتصنيع جهاز جديد للتعقيم الكهربائي للحبوب المخزنة بالصعق الكهربائي. يقوم هذا الجهاز الجديد بتعقيم الحبوب المصابة مباشرة والتخلص من الكائنات الحية سواء كانت حشرات كاملة أو يرقات أو بيض. يقوم الصعق الكهربائي بتدمير المحتوى الرطوبة في الكائنات الحية الموجودة فقط في الحبوب المعالجة دون التأثير عليها. الجهاز مزود بمجموعة من الدوائر الإلكترونية للتحكم الآلي في مستويات الصعق الكهربائي وسرعات الغريال وبريمة الحبوب. أجريت التجارب بأربع سرعات لبريمة الحبوب (0.262 ، 0.524 ، 0.785 ، 1.047 م / ث) مع ثلاثة مستويات من الصعق بالكهرباء (3000، 6000 و 9000 فولت) عند مستويين من سرعة الغريال الكهربائي (0.220 و 0.283 م / ث) مع مستويين من معدل تغذية الحبوب (0.18 و 0.36 ميغا جرام / ساعة). تضمنت النتائج الرئيسية ارتفاع نسبة موت الحشرات (كفاءة التعقيم) إلى 95.42% عند المستويات المثلى للمتغيرات المختبرة. كما انخفضت معدلات ظهور الإصابة الحشرية إلى 11.76% فقط بعد شهر واحد. كذلك ارتفع معدل الإنبات إلى 94.11%. كما انخفضت نسبة الضرر الميكانيكي وفقدان الوزن إلى 5.13% و 4.43% على التوالي. بلغت أقصى إنتاجية للجهاز 0.252 ميغا جرام / ساعة بمعدل استهلاك طاقة نوعي أمثل 1.98 كيلو واط. ساعة / ميغا جرام بتكاليف تشغيل 171.23 جنيه / ميغا جرام. لذلك يمكن استخدام الجهاز الجديد داخل مخازن الحبوب والصوامع لإجراء عمليات التعقيم بشكل دوري بأقل تكلفة إنتاج دون الحاجة إلى الطرق الكيميائية الضارة.