



Feasibility Study for STATCOM'S Capacitor Selection for Voltage Sag Mitigation

Elham M. Tantawy*, Ebrahim A. Badran and Mansour H. Abdel-Rahman

KEYWORDS:
Voltage sag, STATCOM, mitigation, economics, PSCAD/EMTDC.

Abstract— Voltage sags are the most common disturbances associated with power quality. They are caused by short circuits, starting large machines, or energizing a transformer. The main existing technologies for mitigating voltage sag are briefly illustrated. Static Compensators (STATCOM) and dynamic voltage resistors (DVR) are good economic solutions to mitigate voltage sags based on their capabilities. Mitigating devices affect the power flow and voltage profile conditions at both, utility equipment and customers. The impact is on the system voltage profile and on system losses. Using PASCAD/EMTDC, different ratings concerning the capacitor of STATCOM used have been considered and applied to the IEEE 9-bus system. The analysis and studies are carried out in normal and abnormal operating system states. Life cycle cost, maintenance types, and cost are discussed. The status of components of any equipment and its operation condition during its life period is illustrated. The procedure for a feasibility study of STATCOM's capacitor rating selection and economics for voltage sag mitigation is illustrated.

I. INTRODUCTION

RECENTLY and during the current and last decades, electronic equipment and devices are spreadly used. These are sensitive to electrical supply voltage disturbances. Also, with the extensive penetration of renewable energy sources in electrical systems, power quality becomes an important issue.

Voltage sag is a common disturbance caused due to the reclosers to clear non-permanent faults [1].

The voltage sag location in the electrical system is crucial in choosing and developing of voltage sag mitigation strategy. The different methods for improving power quality should be evaluated as cost and the expected achieved performance improvements it provides. With the costs of the different voltage sag mitigation methods and the expected benefits, a study of the various mitigation scenarios yields to a better quick return for the investment [2].

Mitigating devices and the integration of DG in the electrical distribution system has an impact on the power flow

and voltage conditions at customers and equipment. The impact is considered as: impact of DG on system voltage profile, impact on system losses, and impact of DG on harmonics [3].

STATCOM can be used for voltage sag mitigation. It regulates the voltage of the bus by injecting or absorbing the reactive power of the system. Therefore, the STATCOM can operate either as an inductor or as a capacitor depending on the magnitude of the bus voltage.

In this paper, the effect of the capacitance of the STATCOM on voltage sag mitigation is investigated from the technical and economical point of view.

II. VOLTAGE SAG OVERVIEW

The main factors of voltage sag representation are its value and its duration of time. In cases of balanced three phase electrical systems and the electrical single phase systems, the magnitude and duration of sag are fine and enough for sag representation.

Received: (19 July, 2022) - Revised: (10 September, 2022) - Accepted: (13 September, 2022)

*Corresponding Author: Elham M. Tantawy, Ph.D.researcher at Electrical Engineering Department, Mansoura University, Mansoura, Egypt (e-mail: elhamtantawy@yahoo.com).

Ebrahim A. Badran, Professor at Electrical Engineering Department, Mansoura University, Mansoura, Egypt (e-mail: ebadran@mans.edu.eg).

Mansour H. Abdel-Rahman, at Electrical Engineering Department, Mansoura University, Mansoura, Egypt (e-mail: rahman@mans.edu.eg).

For the unbalanced three phase systems sags, all phases affected individually with different values. Therefore, three different values in magnitude and three durations exist and the most affected phase is taken as a measure of sag [4].

Voltage sags can be assessed either by:

- 1) Monitoring of voltages at various buses in the power system for the long term.
- 2) Stochastic simulation approach. It is a process of mathematical numeration depending on computer simulations for voltage sag events. Estimation methods is providing information about the expected severity and frequency of the disturbance and allow the utility to forecast the power quality level on their sites and guide in a realistic way the investment in devices for voltage mitigation [1].

The method of fault positions is used for the calculation of voltage sag magnitude. When applying the fault positions method [2], many cases of faults are to be studied through the electrical the system and the their corresponding values of voltage sags are to be considered and calculated. The calculated and measured values of voltage sags are analyzed. Of the main types of tools used for the simulation is the EMTP (Electromagnetic Transients Program) tools such as PSCAD/EMTDC (PSCAD: Power Systems Computer Aided Design is a powerful and flexible graphical user interface to the world-renowned, EMTDC: Electromagnetic Transients including DC).

A. Voltage Sag losses

The definition of the nominal loss value of a process “maximum loss value”, is the cost losses that occurred through the interruption of supply during maximum production time. This is used as a base for the estimation of cost losses due to the disturbances of the voltage. The main equation for financial loss calculation is given [5] by:

Expected initial loss/sag = Nominal loss * The failure risk of the process. (1)

The nominal value for the loss for customers in the network is computed from customer data surveys. Several studies were conducted to analyze the data result from the disturbances of the survey. Three types of disturbances (voltage sag profile) were classified as the major effectiveness for estimation of costs which are:

Type A: refers to the number of events that are 10 or less voltage sag events through one year. The magnitude of residual voltage less than 40 % of nominal . Voltage sag duration less than 100 ms.

Type B: refers to the number of events which are 10 or less of voltage sag events through one year with residual voltage less than 40 % of nominal and voltage sag duration less than 100 ms, and 5 or less of voltage sag events through one year. The residual voltage magnitude less than 70 % of nominal value. Voltage sag duration between 100 ms and 300 ms.

Type C: refers to the number of events which is one interruption event and 3 minutes or more duration.

Considering the financial loss for interruption as a base, weighting factors for economic analysis of other events are suggested.

III. MITIGATION TOOLS FOR VOLTAGE SAG

The main existing technologies for the mitigation of voltage sag are [3]:

1) Sources of Uninterruptible Power.

A continuous source of electrical energy (Uninterruptible Power UPS) mitigates the sags by supplying the load via stored energy. When the voltage sag is detected, the load is transferred from the main supply to the UPS.

2) Static Transfer Switch.

Static Transfer Switch (STS) is used to facilitate the usage of dual supply, it is a possible technique of mitigation. When the voltage sag is detected, STS can transfer the load from the supply feeder to the other supply feeder through half a cycle [3].

3) Sag Proofing Transformer.

Sag proofing transformers can be used as voltage sag compensators. This basically is a winding transformer connected in series with the load. Sag proofing transformers are effective for voltage sags to approximately 40 % retained voltage.

4) Dynamic Voltage Restorer.

Dynamic voltage restorer (DVR) is a voltage source converter connected in series with supply through an injection transformer where voltage sag or swell takes place. Energy storage in DVR is responsible for supplying active power needed during voltage sag.

5) STATCOM.

STATCOM (static compensator) is a power electronic converter device connected in shunt to the bus. It contains a DC capacitor, voltage source inverter (VSI), coupling transformer, and reactor. The voltage is delivered to the system through the reactance of the coupling transformer and the voltage difference across the reactor produces the active and reactive power exchange between the STATCOM and the network. The STATCOM’s capacitor is sized according to Eqn. (2) [6]:

$$C_{dc} = \frac{S}{2 \omega_g V_{dc}^n V_{dc,ripple}^{max}} \quad (2)$$

where:

C_{dc} : The DC-link capacitor of STATCOM

S : The apparent Power in VA

$V_{dc,ripple}^{max}$: The magnitude of the maximum allowed ripple voltage

V_{dc}^n : DC-link nominal voltage

ω_g : Angular velocity

In this paper, the effect of the capacitance of the STATCOM on the voltage sag mitigation is investigated from the technical and economical point of view.

IV. ECONOMICAL ANALYSIS FOR MITIGATION METHODS OF VOLTAGE SAG.

For making an economical study for the scenarios of mitigation of voltage Sag, It is regarded that the cost of maintenance and operation for the equipment used is the main item. The yearly maintenance expenses for STATCOM'S are in the range of 5 % of its capital cost [7].

A. Modeling for Equipment Life Cycle Cost

The life cycle of equipment passes through four categories [8]:

Development costs C_{Dev} , Equipment C_{eq} , installation C_{in} and maintenance, and operation cost C_M [9] as:

$$\text{Life cycle cost} = C_{eq} + C_M + C_{in} + C_{Dev} \quad (3)$$

B. Equipment Deterioration Condition

Fig. 1a. illustrates the status of an operation for any equipment and its components through its whole lifetime. It begins operation as new in a good efficient state. As the time of operation passed and increased, the state of operation is deteriorated. Therefore, generally, a decaying curve will represent its condition versus time. Straight line representation can be also suitable for representation as illustrated in Fig. 1 (b). After a while, the equipment becomes in a status technically lower than it is new. Therefore, maintenance and perhaps spare parts are required to be replaced. That case is illustrated at the first case on the curve (deterioration begins to be considerable). As the time of the equipment operation increases, the status becomes efficiently lesser till the failure state point is reached. Hence repair is required to be done. At the mentioned functional failure point F the equipment requires to be replaced or requires major maintenance. Fig. 1(b) illustrates system status through the total equipment lifetime with making both types of maintenance. Maintenance is to be done according to the technical system time schedule.

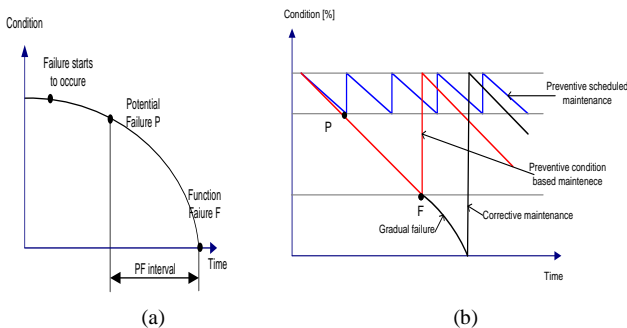

Fig. 1: Status of the system during its lifetime [8].

In order to keep the system components and the whole system in a good and ready operation state at any time through the system life period, the different types of maintenance required are to be properly made in their scheduled time.

Maintenance is defined as a combination of all technical, administrative, and managerial actions during the life period of

an item intended to retain it in or restore it in a state in which it can perform the required function [10].

C. Maintenance Types

Maintenance is generally classified as:

Preventive type maintenance and corrective type maintenance.

1) Preventive maintenance

It is the maintenance that is done before failures happen. can It is classified as:

- i. Preventive scheduled maintenance: It is done through a specified time schedule .
- ii. Preventive condition-based maintenance: It is done based on the technical operation of the equipment. Monitoring the equipment operation and subsequent technical actions control and define the suitable time for making that type of maintenance. To predict it is needed, a history of maintenance (like when, how, and why the component has failed) is collected to make a maintenance data bank for each equipment [10].

2) Corrective maintenance

Corrective maintenance (CM) is the maintenance that is carried out after a fault happened and is intended to put the equipment in a state in which it can perform its function. The CM implies that as long as a component is working no maintenance is carried out; when a component is not working anymore it should be repaired or removed [10].

D. Optimization of Maintenance Cost.

Regarding the cost associated with maintenance, minimization of this cost is required. Therefore,

- 1) Maintenance is done according to the specific time schedule prepared by the equipment manufacturer in order to have good availability of equipment and safety operations.
- 2) Maintenance costs must be as low as possible.
- 3) The equipment after maintenance should have a better state of operation [10].

Fig. 2 illustrates the required total expenses for maintenance as a relation between both maintenance types.

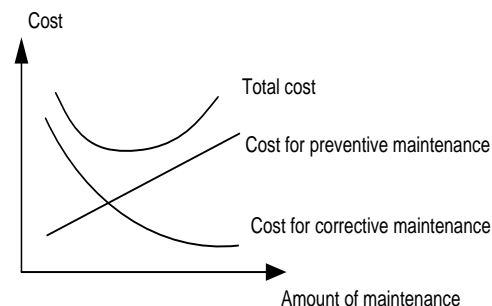

Fig. 2: Balance between preventive and corrective maintenance [10].

The increase in the cost of maintenance and operation is an indicator of equipment deterioration. This increase may make the maintenance cost reach a value higher or near the equipment cost. In such a case, it is preferable economically make a replacement for the equipment. With the new equipment and spare parts, the economical operation can be achieved. Therefore replacement plans by new identical one or more advanced one are required. Maintenance and replacement plans are important for economics and safe operation.

E. Economical Measures

There are two common economic measures are used for the optimal selection of voltage sag mitigation solutions. These measures are designated as “benefit-cost ratio” and “payback period” which are defined as:

1) Benefit-cost ratio (B/C)

It is an economic measure [11]. It indicates the economic feasibility of the application of any specific scenario for voltage sag mitigation solutions.

2) Payback period (PP)

The payback period (PP) is another economic measure. It illustrates the time interval (e.g. period in years and months) require for the project to retain the investment cost [10]. For the mitigation of voltage sag problems, it could be calculated as:

$$PP = \frac{\text{Net Investment}}{\text{Net Annual Return}} \quad (4)$$

The preferred solution is in which the payback period is minimum.

F. Economic Power System Operation

The economics of power system operation is an optimization problem with aim of minimizing the financial loss which happened because of the voltage disturbances with a minimum cost of investment. The cost of FACTS (Flexible AC Transmission System) devices [12] are given by (5) and (6):

$$C_{STATCOM} = 53.2 * S_{STATCOM}^2 + 5.856 * S_{STATCOM} + 220.22 \quad (5)$$

$$C_{SVC} = 53.2 * S_{SVC}^2 + 7.833 * S_{SVC} + 0.33894 \quad (6)$$

where:

- $C_{STATCOM}$: STATCOM Price in Dollar.
- $S_{STATCOM}$: STATCOM Rating in MVAR.
- C_{SVC} : SVC (Static Var Compensator) Price in Dollar.
- S_{SVC} : SVC (Static Var Compensator) Rating in MVAR.

Economically the most important factor in voltage disturbances management is the minimization of the cost of the mitigation technique and the losses cost of the voltage sag, as given by (7).

$$\text{Optimal case} = \text{Min. (Sag financial loss + cost of mitigation)} \quad (7)$$

Therefore,

$$\text{Value of service} = \text{Initial financial losses} - (\text{Cost of mitigation} + \text{Residential losses}) \quad (8)$$

Eqn. (8) indicates that profit and gain for investment return are achieved in the case of positive value for the value of service.

V. TEST SYSTEM SIMULATION

IEEE 9-bus test system shown in Fig. 3 is studied in the normal operating conditions and different loading conditions.

A. System Simulation

PSCAD/EMTDC software package is applied to simulate The simulation is checked and verified. This is assured through comparing the results of the load flow study and that published in [13]. Table 1 illustrates the results in both cases. The agreement between the two results is clear.

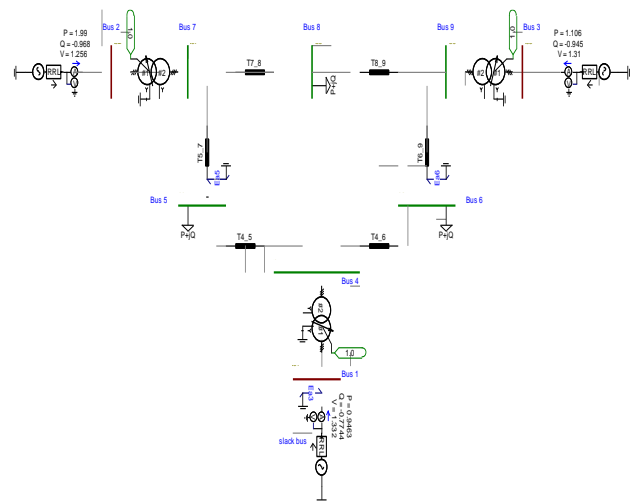

Fig. 3: IEEE 9bus test system model in PSCAD/EMTDC.

TABLE 1
VERIFICATION OF THE TEST SYSTEM SIMULATION.

Bus	Published results		PSCAD results	
	P (PU)	Q (PU)	P (PU)	Q (PU)
1	0.7152	0.2761	0.7151	0.2760
2	1.6320	0.0454	1.6320	0.0454
3	0.8512	-0.1170	0.85121	-0.1171
From Bus	To Bus			
4	5	0.4322	0.4322	0.4322
4	6	0.2830	0.2830	0.2831
5	7	0.8340	0.8340	0.8341
6	9	0.6340	0.6340	0.6341
7	8	0.7892	0.7892	0.7891
8	9	0.2172	0.2172	0.2173

B. Results of System Operation

Fig. 4 illustrates the waveform of voltage at buses 2 and 8 during the normal operation respectively.

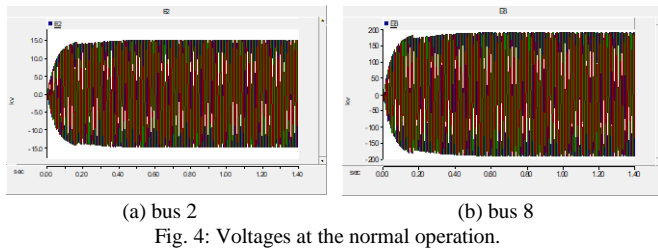

Fig. 4: Voltages at the normal operation.

Load is suddenly increased at bus 8. Figs. from 5 to 9 illustrate the voltages waveforms at buses 2 and 8 when the load at bus 8 is suddenly increased by different values during the period from 1 to 1.05 s. The voltage sags are notable.

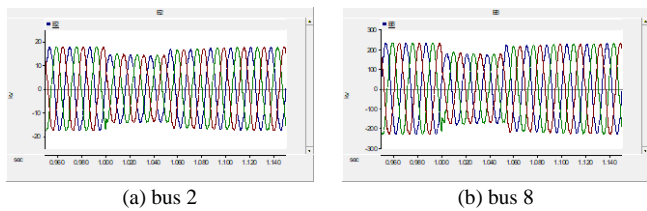

Fig. 5: Voltage when the load is increased by 100% at bus 8.

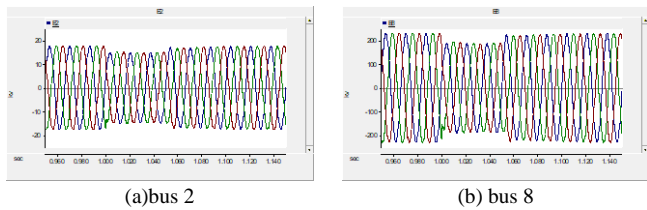

Fig. 6: Voltage when the load is increased by 80% at bus 8

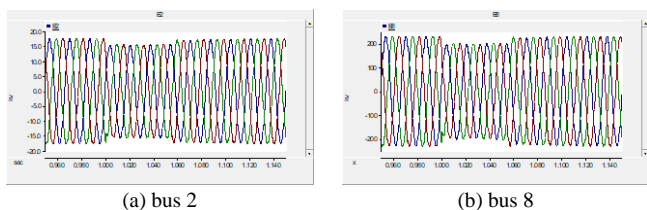

Fig. 7: Voltage when the load is increased by 60% at bus 8

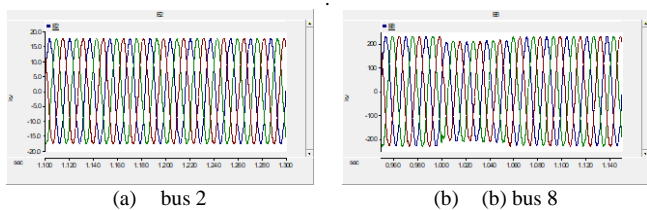

Fig. 8: Voltage when the load is increased by 40% at bus 8

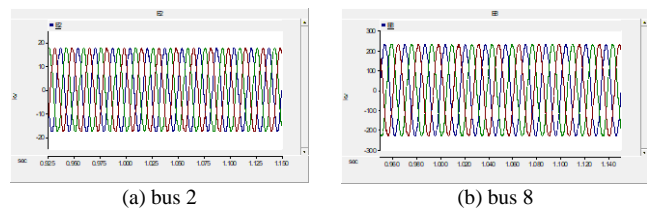

Fig. 9: Voltage when the load is increased by 20% at bus 8.

Table 2 illustrates the voltages at buses 2 and 8 for sudden load variations at bus 8.

TABLE 2
MAGNITUDE OF THE VOLTAGE FOR DIFFERENT LOADS

Position	% Load increasing at bus 8	Voltage at Normal Operation (kV)	Voltage at Overloading (kV)	Sag %
bus 2	100 %	17.9	14.3	0.2
	80 %	17.6	14.8	0.15
	60 %	17.8	15.4	0.13
	40 %	17.6	16.12	0.08
	20 %	17.8	17.3	0.02
bus 8	100 %	230	176.6	0.23
	80 %	229.8	186.14	0.18
	60 %	230	195	0.15
	40 %	229.8	207.3	0.09
	20 %	229.8	228.6	0.00522

C. Effect of Transmission Lines Impedance on the System Voltage

Increasing the transmission line impedances has a vital effect on voltage magnitude at the different buses. Therefore, the case of increasing system impedances is studied. The voltages waveforms are seen in the set of Figs. Fig. 10 illustrates the sag that happens at bus 8 when the load is suddenly increased by 100% and 80% at bus 8 in the period from 1 to 1.5 sec. Furthermore, Table 3 illustrates voltage values at the system buses when increasing the system impedance to double.

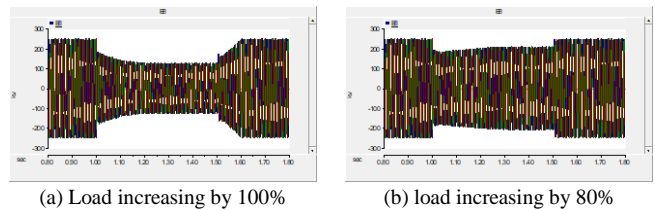

Fig. 10: The voltage at bus 8 in case of double system impedance and load increases by 100% and 80% at bus 8 from 1 to 1.5 s.

TABLE 3
COMPARISON OF BUSSES' VOLTAGES AT NORMAL OPERATION AND INCREASED SYSTEM IMPEDANCES.

Bus number	Voltage in kV				
	At normal operation	At double system impedance	Sag %	At 80% increase in system impedance	Sag %
1	16.5	12.1	0.26	16	0.03
2	18.4	11.6	0.36	16.4	0.1
3	13.8	9.3	0.32	13.4	0.02
5	250	148	0.408	229	0.084
6	254	141.5	0.442	230	0.09
8	246	125.5	0.48	206	0.16
9	230	117.3	0.44	192.6	0.14

VI. FEASIBILITY STUDY THE STATCOM’S CAPACITOR SELECTION FOR MITIGATION OF VOLTAGE SAG

STATCOM is used for mitigation of voltage sag with the test system considering the above cases and with different STATCOM’s capacitor values. According to Eqn. (2), the STATCOM’s capacitance affects the output reactive power in case of constant of other parameters. For a constant dc voltage and frequency and a controlled dc ripple, the STATCOM’s output is directly proportioned with its capacitance.

Fig. 11 shows the voltage waveform at bus 8 for different STATCOM’s capacitor values. The voltage waveform at bus 8 when the load is doubled from 1.0 to 1.5 sec and a STATCOM of 300 MVAR is applied from 1.2 to 1.55 sec is shown in Fig. 11a. Also, Fig. 11b shows the voltage waveform at bus 8 when the load is doubled and a STATCOM of 225 MVAR is applied. Furthermore, Fig. 11c, Fig. 11d, and Fig. 11e show the voltage waveform at bus 8 when the load is doubled from 1.0 to 1.5 sec and a STATCOM of 200 MVAR, 150 MVAR, or 100 MVAR is applied from 1.2 to 1.55 sec, respectively.

The STATCOM is added at bus 8. Also, Table 4 gives a comparison of the voltages of buses in the case of different STATCOM’s capacitor ratings. The sag for each case is given. It is clear that the best STATCOM’s capacitor rating gives 200 MVAR for one unit at bus 8 according to the best sag percentage from the results and the STATCOM’s capacitance used is 31.47 F.

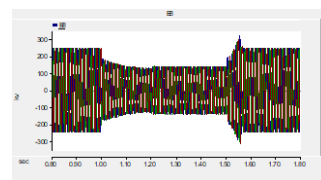
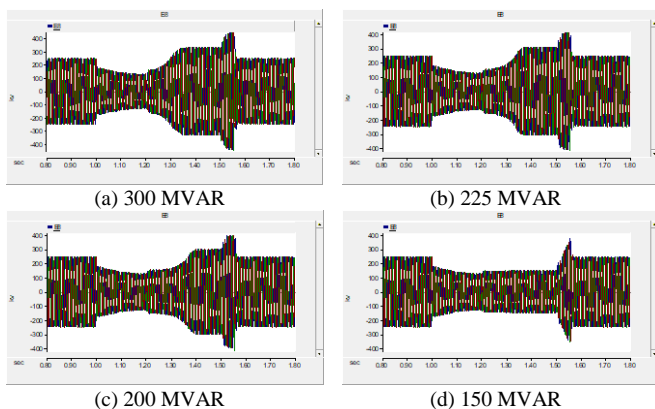

(e) 100 MVAR

Fig. 11: The voltage at bus 8 in case of adding STATCOM with a different rating of the capacitor at bus 8.

By adding smaller units of STATCOM at buses 5, 8, and 9, Fig. 12 shows the voltage waveform at bus 8 for different STATCOM’s capacitor values when the load is doubled and three STATCOM units of 100 MVAR are applied as shown in Fig. 12a and 75 MVA in Fig. 12b.

Furthermore, Fig. 12c, Fig. 12d, and Fig. 12e show the voltage waveform at bus 8 when the load is doubled from 1.0 to 1.5 sec and three units of STATCOM of 50 MVAR, 40 MVAR, or 30 MVAR are applied from 1.2 to 1.55 sec, respectively. Also, Table 5 gives a comparison of the voltages of buses in the case of different STATCOM’s capacitor values of each unit of the three STATCOM units used on buses 5, 8, and 9. The sag of each case is given. It is found that the best STATCOM’s capacitor gives 40 MVAR for each unit at buses 5, 8, and 9 according to the best sag percentage from the results, and the STATCOM’s capacitance used is 6.29 F for each capacitance.

The sag losses for different industries can be expected as given in [14]. For a 20 years lifetime of the sag mitigation using the proposed STATCOM, the sag losses are calculated. It is found to be nearly 493,333.33 \$.

From Eqn. (5), it can be found that the cost of each unit of 40 MVAR STATCOM is 1.6 M\$ [15]. However, the cost of 200 MVAR STATCOM is 8 M\$ [16]. Also, the accumulated annual cost corresponding to the savings due to employing a mitigation solution is calculated. Table 6 summarises the comparison between the B/C ratio and the Payback Period (PP) for the two suggested STATCOM ratings [17], [18].

It is clear that from an economic point of view, using three units of 40 MVAR STATCOMs is better than using one unit of 200 MVAR STATCOM.

TABLE 4
MAGNITUDE BUS VOLTAGES AND SAG VOLTAGE FOR ONE STATCOM ADDED AT BUS 8.

Bus number	Voltage in kV at double system impedance case	Voltage in kV at 100% increasing load	Capacitor rating of the STATCOM and the mitigated voltage									
			300 MVAR		225 MVAR		200 MVAR		150 MVAR		100 MVAR	
			kV	Sag%	kV	Sag%	kV	Sag%	kV	Sag%	kV	Sag%
1	16.5	12.1	17.3	-0.04	18.7	-0.13	18.05	-0.09	11.9	0.27	12.3	0.25
2	18.4	11.6	18.2	0.01	16.2	0.11	18.7	-0.016	9.94	0.45	11.8	0.35
3	13.8	9.3	16.1	-0.16	17.9	-0.29	16.05	-0.16	12.5	0.09	9.78	0.29
5	250	148	259	-0.036	308.2	-0.232	257	-0.028	144.8	0.42	253.4	-0.01
6	254	141.5	263.3	-0.036	264.5	-0.041	267	-0.05	156.6	0.38	145.3	0.42
8	246	125.5	328.8	-0.336	269.4	-0.095	273.8	-0.11	147.4	0.47	140	0.43
9	230	117.3	307.4	-0.13	251.8	-0.01	255.9	-0.011	137.8	0.59	130.8	0.56

TABLE 5
MAGNITUDE BUS VOLTAGES AND SAG VOLTAGE FOR TREE STATCOM UNITS ADDED AT BUSES 5, 8, AND 9.

Bus number	Voltage in kV at double system impedance case	Voltage in kV at 100% increasing load	Capacitor rating of the STATCOM and the mitigated voltage									
			100 MVAR		75 MVAR		50 MVAR		40 MVAR		30 MVAR	
			kV	Sag%	kV	Sag%	kV	Sag%	kV	Sag%	kV	Sag%
1	16.5	12.1	21.1	-0.27	20.3	-0.23	19.1	-0.15	18.6	-0.12	13.6	0.17
2	18.4	11.6	19.7	-0.07	19.2	-0.04	18.38	0.001	18.01	0.02	12.18	0.33
3	13.8	9.3	18.7	-0.35	17.5	-0.26	16.1	-0.16	15.6	-0.13	11.2	0.18
5	250	148	336	-0.344	310.8	-0.24	282.3	-0.129	271.3	-0.085	191	0.236
6	254	141.5	318	-0.25	298.7	-0.17	276.2	-0.05	267.2	-0.05	180.1	0.29
8	246	125.5	308	-0.25	385	-0.56	258.5	-0.05	247	-0.004	249	-0.012
9	230	117.3	287.9	-0.012	359.9	-0.15	241.6	-0.01	230.9	-0.001	232.8	-0.012

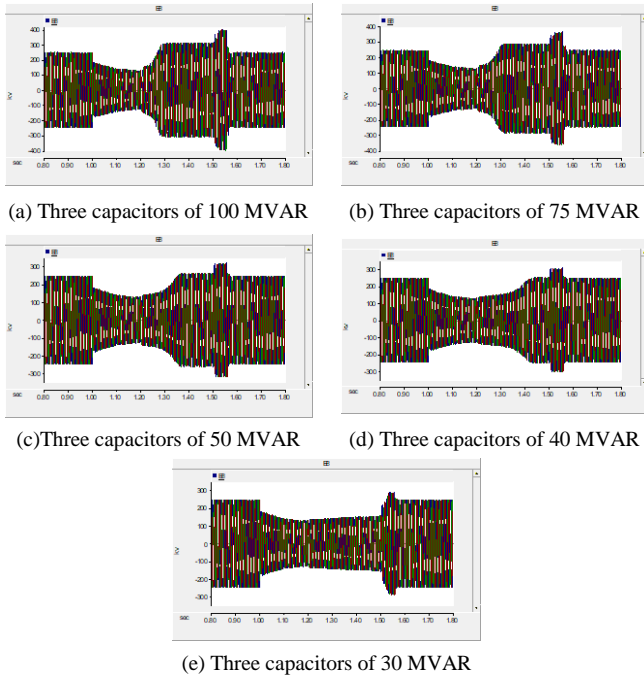

Fig. 12: The voltage at bus 8 in case of adding three units of STATCOM with different ratings of the capacitor at buses 5, 8, and 9.

TABLE 6
VALUES OF B/C RATIO AND PP IN TWO DIFFERENT CASES

	B/C ratio	PP
Three units of 40 MVAR STATCOM	0.446	10.7 y
200 MVAR STATCOM	0.834	17.83 y

VII. CONCLUSION

Voltage sags are the most harmful power quality disturbances that are due to their costly impact on sensitive loads. The different known technologies for voltage sag mitigation are evaluated in cost. Also, the expected performance improvements achieved are determined.

Then, the technical improvements achieved are translated and transferred to economic cost benefits. Regarding the costs

associated with the various locations and sizes of STATCOM's capacitor used and the expected benefits, a comparison of the various technologies is made. This yield to the optimal return on investment. The economical scenario is which corresponds to the least total expenses and that considers the expenses of the mitigation equipment. Life cycle cost, maintenance types, and cost are carried out.

A feasibility study is performed on the 9-bus system with different values of STATCOM's capacitor at different locations of STATCOM as a voltage sag mitigation method. From the results of the study, using small ratings of STATCOM's (i.e., capacitor value) at different busses is better than concentrating it on one bus.

AUTHORS CONTRIBUTION

- 1- Conception or design of the work. (Eng. E. Tantawy 20%, Prof. E. Badran 40%, and Prof. M. Abdel Rahman 40%)
- 2- Data collection and tools. (Eng. E. Tantawy 60% and Prof. E. Badran 40%)
- 3- Data analysis and interpretation. (Eng. E. Tantawy 60% and Prof. E. Badran 40%)
- 4- Investigation. (Eng. E. Tantawy 70% and Prof. E. Badran 30%)
- 5- Methodology. (Eng. E. Tantawy 60% and Prof. E. Badran 40%)
- 6- Project administration. (Eng. E. Tantawy 20%, Prof. E. Badran 60%, and Prof. M. Abdel Rahman 20%)
- 7- Resources. (Eng. E. Tantawy 50% and Prof. E. Badran 30% and Prof. M. Abdel Rahman 20%)
- 8- Software. (Eng. E. Tantawy 80% and Prof. E. Badran 20%)
- 9- Supervision. (Dr. E. Badran 50% and Dr. M. Abdel Rahman 50%)
- 10- Drafting the article. (Eng. E. Tantawy 50 % and Prof. E. Badran 30% and Prof. M. Abdel Rahman 20%)
- 11- Critical revision of the article. (Prof. E. Badran 70 % and Prof. M. Abdel Rahman 30 %)

12- Final approval of the version to be published. (**Prof. E. Badran** 50 % and **Prof. M. Abdel Rahman** 50 %)

FUNDING STATEMENT

Authors didn't receive any financial support for the research, authorship

DECLARATION OF CONFLICTING INTERESTS STATEMENT

The authors declare that they have no known competing financial interests or personal relationships that could have appeared to influence the work reported in this paper.

REFERENCES

- [1] Y. Zhang, F. Li, Z. Hu, and G. Shaddick, "Quantification of Low Voltage Network Reinforcement Costs", IEEE Transactions on Power Systems, May 2013, vol. 28, No. 2, pp. 810 - 818.
- [2] IEEE Std 1250, "IEEE Guide for Identifying and Improving Voltage Quality in Power Systems", IEEE Transmission and Distribution Networks Committee, March 2011.
- [3] J. Milanović and Y. Zhang, "Modeling of FACTS Devices for Voltage Sag Mitigation Studies in Large Power Systems.", IEEE Transactions on Power Delivery, October 2010, vol. 25, No. 4, pp. 3044–3052.
- [4] Y. A. R. I. Mohamed, "Mitigation of Dynamic, Unbalanced and Harmonic Voltage Disturbances Using Grid-Connected Inverters with LCL Filter", IEEE Transactions on Industrial Electronics, September 2011, vol. 58, No. 9, pp. 3914 – 3924.
- [5] N. Daratha, B. Das, and J. Sharma, "Coordination Between OLTC and SVC for Voltage Regulation in Unbalanced Distribution System Distributed Generation.", IEEE Transactions on Power Systems, January 2014, vol. 29, No. 1, pp. 289–299.
- [6] X. Zong, "A Single Phase Grid Connected DC/AC Inverter with Reactive Power Control for Residential PV Application", Thesis, University of Toronto, 2011.
- [7] M. El-Gammal, A. Abou-Ghazala and Tarek I. El-Shennawy "Costs of Custom Power Devices versus the Financial Losses of Voltage Sags and Short Interruptions: A Techno-economic Analysis", International Journal of Computer and Electrical Engineering, October 2010, vol. 2, No.5.
- [8] A. Selim, S. Kamel, and F. Jurado, "Voltage stability analysis based on optimal placement of multiple DG types using hybrid optimization technique", International Transactions on Electrical Energy Systems, August 2020, pp. 1-20.
- [9] M. Mostafa, S. Aleem, S. Ali, Z. Ali, and A. Abdelaziz, "Techno-economic assessment of energy storage systems using annualized life cycle cost of storage (LCCOS) and levelized cost of energy (LCOE) metrics," *J. Energy Storage*, vol. 29, p. 101345, 2020.
- [10] A. Jardine and A. Tsang, "Maintenance, Replacement, and Reliability", Book, USA: Taylor Francis, 2006.
- [11] L. Tuladhar and F. Villaseca, "Dynamic Voltage Restorer with Active Disturbance Rejection Control", *Journal of Energy and Power Engineering*, vol. 8, No. 12, pp. 2080-2088, 2014.
- [12] K. Habur, Klaus. "FACTS for cost effective and reliable transmission of electrical energy." www.worldbank.org/html/fpd/em/transmission/facts_siemens.pdf (2002).
- [13] https://hvdc.ca/uploads/knowledge_base/ieee_9_bus_technical_note.pdf
- [14] E. Tantawy, E. Badran, and M. Abdel-Rahman, "Techno-Economic Assessment of Voltage Sags Mitigation in Distribution System Connected to DGs", *International Transactions on Electrical Energy Systems*, 2022.
- [15] F. Salim, K.Nor, D. Said, A. Rahman, "Voltage Sag Cost Estimation for Malaysian Industries" *IEEE International Conference Power & Energy*, 2014.
- [16] Y. Zhang, "Techno-economic Assessment of Voltage Sag Performance and Mitigation", Thesis, Manchester university, 2008.
- [17] M. Kermani, G. Parise, B. Chavdarian, L. Martirano, "Ultracapacitors for Port Crane Applications: Sizing and Techno-Economic Analysis". *Energies*, April 2020, 13(8), 2091.
- [18] S. Kumar and C. Sethuraman, "Sizing Optimization and Techno-Economic Analysis of a Hybrid Renewable Energy System Using HOMER Pro Simulation," 2021.

Title Arabic:

دراسة جدوى لاختيار مكثف لمعوض الجهد الاستاتيكي لتخفيف ترهل الجهد

Arabic Abstract:

ترهل الجهد يعتبر أكثر اضطرابات الجهد شيوعاً والمرتبطة بجودة الطاقة الكهربائية. ويكون ذلك ناتجاً عن قصر الدوائر أو بدء تشغيل الآلات الكهربائية كبيرة القدرة أو تنشيط المحولات الكهربائية أو ... الخ. تم توضيح التقنيات الرئيسية المتاحة لتخفيف هذا الترهل بايجاز. ويعد معوض الجهد الديناميكي ومعوض الجهد الاستاتيكي حلاً اقتصادياً جيداً للتخفيف من ترهل الجهد بناءً على قدراته. تؤثر أجهزة التخفيف على تدفق الطاقة وظروف الجهد في كل من العملاء ومعدات المرافق. يكون التأثير على ملف جهد النظام وعلى خسائر النظام. وقد تم إجراء هذه الدراسة على نظام توزيع كهربائي في ظروف التشغيل الطبيعية والطارئة. كما تم دراسة عناصر تكلفة المعوضات اخذاً في الاعتبار مناقشة حالة هذه الاجهزة اثناء تشغيلها خلال عمرها الافتراضي وطرق صيانتها مع توضيح انواع الصيانات التي يتطلبها ومناقشة المعايير الاقتصادية المستخدمة. يتم توضيح حالة أي جهاز ومكوناته مع تشغيله خلال فترة حياته. كما تم توضيح إجراءات دراسة الجدوى لاختيار قيم معوض الجهد الاستاتيكي للحصول على حل اقتصادي لترهل الجهد .