

Beyond the Naos: A Revisited Naos of Edfu

Taher Abdelhamid and Eslam Salem

Tourism Guidance Department, Faculty of Tourism and Hotels, Fayoum University

Abstract

The present paper aims to revisit the Late Period naos, particularly naos of Edfu. During the 30th Dynasty, King Nectanebo I began a wave of important construction activities throughout Egypt, and later King Nectanebo II completed this effort. Among the monuments constructed were naos, or sacred shrines that housed the cult statue of the local deity during religious festivals. Among the materials used in the construction were red granite, light gray granite, green slate, and black syenite. Wood was also often used as one of the materials, either for the entire naos or for one of its parts. It is notable that the majority of the naos that still exist are those made of stone. Sadly, those made of wood have almost completely vanished. Most previous studies on 30th Dynasty naos have concentrated on those of Lower Egypt, resulting in a lack of in-depth research into their Upper Egyptian contemporaries. In an attempt to remedy this gap, the current study contains an examination of the naos of King Nectanebo II found at Edfu. Considered to be the oldest element in the temple, it occupies the middle part of the sanctuary and provides physical evidence of the orientation of the temple started from the New Kingdom until the collapse of the 30th Dynasty. Texts on the naos reflect the religious role of the naos and mention cult centers. This paper provides a revisit of the Edfu naos to illuminate this type of architecture and its role within Late Period temples, looking particularly at its location within the temple, construction material, architectural design, function, dedication, decorative symbolism, and the religious concepts behind the texts.

Keywords: Naos – 30th Dynasty – Late Period – Nectanebo II – Edfu

Introduction

The Egyptian Late Period (25th–30th Dynasties, 525–332 B.C.E.)¹ is considered a distinct era of achievements in ancient Egyptian history. The 30th Dynasty, which is considered the last Egyptian native dynasty,² encompasses the reign of three kings, Nectanebo I, Teos, and Nectanebo II;³

¹ K. Kitchen, (1991), *The Chronology of Ancient Egypt*, World Archaeology 23, no. 2 (1991): 206, <http://www.jstor.org/stable/124743>.

² D. Leo, "Saite & Persian Egypt (206), 664 B.C.E. (Dy. 26-31, Psammetichus I to Alexander's Conquest of Egypt, in *Ancient Egyptian Chronology: Handbook of Oriental Studies, Section 1, The Near and Middle East 83*, ed. Hornung, Erik, Rolf Krauss, and David A. Warburton (Leiden/Boston: 2006), 270.

³ D. Hogarth, "Nectanebo, Pharaoh and Magician," *The English Historical Review* 11, no. 41 (1896): 1-3, <http://www.jstor.org/stable/547514>; F. Petrie, *A History of Egypt: From the XIXth to the XXXth Dynasties*, vol. 3 (London, 1905), 378; S. Wilhelm, *Die Sogenannte Demotische Chronik: des Pap. 215 der Bibliothèque nationale zu Paris nebst den auf der Rückseite des Papyrus stehenden Texten* (Toronto, 1914), 6; J. Cléré, "A Propos de L'ordre de Succession des Rois de la XXXth Dynastie," *Revue d'Égyptologie* 8 (1951): 25-29; L. Miriam and Joseph G. Manning, *Chronology of the Late Period in Ancient Egyptian Literature*, The Late Period, vol. 3 (California, 2006), Ix-X, <http://www.jstor.org/stable/10.1525/j.ctt1pp5vf.3>; G. Gilles, "Nectanebo-Le-Faucon' Et La Dynastie Lagide," *Ancient Society* 39 (2009): 55-57, <http://www.jstor.org/stable/44079918>; F. Annie, *Nectanébo: La dernière dynastie égyptienne*, (Paris: Khéops 2018).

during this period, Samanud served as the capital of Egypt.⁴ Most of the buildings of this dynasty were constructed by its first and the last kings.⁵ Many architectural elements were created during the 30th Dynasty, including the so-called naos.⁶ A naos is a tabernacle or sacred shrine that served primarily to house the cult statue of the local deity during religious festivals and ceremonies.⁷ The word originated from a Greek term (ναός) referring to the god’s shrine (in Egyptian, *ntr*) or the most sacred place in the temple.

The ancient Egyptians usually employed hard stones to construct this type of monument; they also used wood, but the wooden examples have not survived as well as the stone ones.⁸ In form, the naos was an upright rectangular box with, on one side, an opening fitted with a gilded wooden door. Its inner and outer faces were covered with inscriptions.⁹ Because it housed the representation of the deity, the ceiling was considered to be the heavens. There is a paucity of studies dealing with this architectural form, especially in Upper Egypt during the Late Period. Even the present work discusses only one of the nine Upper Egyptian naoi cataloged in table 2: that dedicated by Nectanebo II in the temple of Edfu, which was selected because it is the best-preserved example from this region and period. While most other naoi are unfortunately missing many of their elements, the Edfu naos was discovered intact except the doors are missing. This study offers new insights, such as the religious meaning of its texts.

General Description

Table 1—General description of the naos of king Nectanebo II at Edfu.

Name	<i>k3r</i> ^a
Location	Northwest corner of the sanctuary ^b ; now located in the middle of the sanctuary (fig. 1)
Date	30th Dynasty-reign of Nectanebo II (<i>s3 Rꜥ -mry ꜥmn- nht ꜥr ꜥbt</i>) (360–343 B.C.E)
Material	Black Granite ^c (<i>m3t</i>) - one piece
Measurements	4.17 m high, 2.20 m wide
<p><i>Notes:</i> ^a N. Spencer, “Shrine,” in <i>UCLA Encyclopedia of Egyptology</i> 1(1), ed. Willeke Wendrich (Los Angeles, 2010), 2-4. ^b This is the original location during the time of discovery; see D. Arnold, <i>Temples of the Last Pharaohs</i> (New York/Oxford, 1999), 339, note. 135. ^c It should be noted that the naos material appears clearly in its hieroglyphic name, which is <i>k3r šps m m3t</i>, “glorified chapel made of black granite.”</p>	

⁴ D. Arnold (1999), *Temples of the Last Pharaohs*, (New York/Oxford, 1999), 93.

⁵ H. Jenni (1998), Elephantine XVII: Die Dekoration des Chnumtempels durch Nektanebos II, in *Die Dekoration des Tempelhaustores unter Alexander IV. und der Südwand unter Augustus*, Mit einem Beitrag von S. Bickel, AVDAIK 90 (Mainz, 1998), 87-101.

⁶ For further publications on naoi, see K. Myśliwiec(1978), La Naos de Pithom, *Bulletin de l'Institut Français d'Archéologie Orientale* 78 (1978): 171-195 ; F. Burgos, L. François, & N. Grimal(2006), *La chapelle rouge: Le Sanctuaire de Barque d'Hatshepsout, Fac-similés et photographies des scènes*, vol. 1 (Paris, 2006).

⁷ N. Spencer (2006), *A Naos of Nekhthorheb from Bubastis: Religious Iconography and Temple Building of the 30th Dynasty* (London, 2006), 31-38.

⁸ S. Ian & N. Paul (1995), *the Dictionary of Ancient Egypt*, the British Museum (Cairo, 1995), 195.

⁹ For further information about the naos innovation(2010), see N. Spencer, Shrine, in *UCLA Encyclopedia of Egyptology* 1(1), ed. Willeke Wendrich (Los Angeles, 2010), 2-4; The pre-dynastic chapels noted by K. Barry, *Ancient Egypt: Anatomy of a Civilization*, 2nd edn., (New York, 2006), 142-150, figs. 50-52; For the middle Kingdom examples, see M. Pillet, “Le Naos de Senouset I, *Annales du Service des Antiquités de l'Égypte* 23 (1923): 143-158.

The naos of king Nectanebo II¹⁰ is considered a unique monument among the elements of Edfu temple, where it still occupies the center of the main sanctuary (fig. 1).¹¹ The naos (fig. 2) stands on a pedestal. It measures approximately 4.17 m high x 2.2 m width (table 1). Walls are slightly battered and are topped by a cavetto cornice, which features a torus, as does each of the vertical corner edges. Above the cornice, the roof takes the form of a pyramid, without any decorations. Unfortunately, the door is missing, but this seems to have been small.¹²

Decorations and Reliefs

Inscriptions and imagery cover both inner and outer sides of the naos. The interior has two figural decorations (on its ceiling and inner lintel), while the exterior features decoration on the cornice, upper lintel, and the two jambs.

Interior Part

Decorations of the Inner Lintel

An illustration (*hpy*) of the winged solar disk appears on the inner lintel. Its two wings bend downward, while hanging from the disk are two protective uraei, each holding a feather called *hw*. Between them, three marvelous sun rays extend downward from the sun disk toward the phonogram of *Bhdt* (Edfu). Below this there is a representation of a mountain (*dw*) from which emerges a composite figure consisting of a winged scarab holding the so-called *sn*, the sign of eternity. From the body of the beetle emerge two falcon heads: one appears wearing the double crown, while the other one appears wearing the crown of Re. Below the scarab, and touched by the solar disk's wingtips, is the *pt* sign, signifying "sky" (fig. 3).

Decorations of the Inner ceiling

The center of the ceiling is ornamented with a row of five figures, the day cycle representation, all with outstretched wings (fig. 4): the scene begins from the outside, the southern part and then ends at the interior, the northern part according to the following design: a scarab (referring to resurrection and morning); a falcon wearing a solar disk (referring to daytime); a vulture with a snake head wearing the red crown (Wadjet); a vulture wearing "Atf" crown (Nekhbet); and, finally, a ram-headed scarab (referring to night). Above each wing of these figures is a parallel line of hieroglyphic text (fig. 5). Overall, the serpent is the goddess *Wadjet*, worshiped as the patron deity of Lower Egypt (Northern Egypt).¹³ While the ram headed scarab embodies the night part of the day. In sum, these representations symbolize the day cycle and its relationship with Upper and Lower Egypt.

Inscriptions of the Inner ceiling

The right side (West) (fig. 5) (→):

¹⁰ F. M. W. Petrie, (1905), A History of Egypt: From the XIXth to the XXXth Dynasties, vol. 3 (London, 1905), 382, fig. 157; G. Legrain, "Le logement et transport des barques sacrées et des statues des dieux dans quelques temples égyptiens," Bulletin de l'Institut Français d'Archéologie Orientale 13 (1917): 67–69, fig. 5; E. Rougé, Inscriptions et notices recueillies à Edfou (Haute Egypte) pendant la mission scientifique de M. le vicomte Emmanuel de Rougé (Paris, 1880), pl. 161[top].

¹¹ D. Arnold (1999), Temples of the Last Pharaohs, (New York/Oxford, 1999), 339.

¹² D. Arnold (1999), Temples of the Last Pharaohs (New York/Oxford, 1999), 339.

¹³ Kasia Szpakowska (2015), Snake Cults and Military Life in New Kingdom Egypt, in Walls of the Prince: Egyptian Interactions with Southwest Asia in Antiquity. Essays in Honour of John S. Holladay Jr (Brill, 2015), 274.



*Hr Bhdty ntr ʿ3 nb pt s3b šwt prj m 3ht(j)
hnt(j) štyt šmʿw hnt(j) Ndm ʿnh*

Behdetite, the great god, lord of the sky, he of colorful plumage who appears from the horizon in front of the southern chapel that located before Nedjem-ankh (Dendera).^{14,15}

*Nhbt hdt Nhn nbt pt hnwt t3wj dj=s
ʿnh w3s mj Rʿ*

Nekhbet, the White One of Nekhen, is the Lady of the Sky and the Two Lands, and she, like Re, gives life and authority.

*Hr Bhdty ntr ʿ3 nb pt s3b šwtj prj m 3ht hnt(j)
hbnw*

Wadjet of Dep and the city of Pe, lady of the sky and the Two Lands, she gives birth to the son of Re [Hathor's beloved, Amun's son, strong Horus of Hebt-city].

Bhdtyj ntr ʿ3 nb pt nb Msn prj m 3ht di(=f) ʿnh

Behdetite, the great god, lord of the sky, he of multicoloured plumage, who emerges from the horizon first and foremost of the city of Hebenu.¹⁶

¹⁴ For original inscription, see M. Rochemonteix & É. Chassinat(1897), Le Temple d'Edfou, vol. 1 (Paris, 1897), 11. The previous citation will be abbreviated from here onwards to be Edfou I.

¹⁵ This was one of the names of Elephantine Island, the first province of Upper Egypt. It refers to one of the chapels in Edfu temple, which was called $\text{𓆎} \text{𓆏}$ (*ndm-ʿnh*). Also, this name sometimes refers to the temple of Edfu itself when the word is followed by the sign of the house. However, when this word is followed by the determinative of a town, it refers to the Dendara temple of Hathor, and in this case, the word generally means delightfulness of life. There is, furthermore, a title of Osiris, $\text{𓆎} \text{𓆏}$ (*ndm-ʿnh*). Erman claimed that Osiris was one of the essential deities of Elephantine region, so that he took the title of *ndm-ʿnh* as well, see E. Adolf & G. Hermann (1971), Wörterbuch der ägyptische Sprache, zweiter band, (Berlin, 1971), 379 [19].

¹⁶ Hebenu played an essential center as the capital of the 16th Nome of Upper Egypt, see F. Gomaà (1977), Hebenu, in Lexikon der Ägyptologie 2, ed. Wolfgang Helck and Wolfhart Westendorf, 1075-1076 (1977). There was another city called Hebenu located in Lower Egypt, in the eastern delta, see M. Pierre (1957), Géographie De

Bḥdtj nṯr ʕ3 nb pt nb Msn prj m 3ḥt di(=f) ʕnh Behdetite, the great god, lord of the sky, lord of Mesen,¹⁷ He who appears from the horizon and gives birth.

The left side (East) (fig. 5) (←):



Bḥdtj, nṯr ʕ3 nb pt, nb Msn ḥnt(j) šḥt Mḥw ḥnt(j) ḥʕ(w)-ʕnh Behdetite, the great deity, lord of the sky, lord of Mesen, who is the foremost of the northern chapel in front of (Dendera).^{18,19}

Nḥbt ḥdt Nḥn 3w(t)-ʕ nb(t) fʕgt di=s ʕnh The white Nekhbet who belongs to Nekhen, tallest is her arm, lady of Faget-city²⁰, she gives life.

W3ḏjt P p nb(t) pt t3wj di(=s) ʕnh n nṯr nfr [snḏm jb Rʕ stp.n jni ḥrt] Wadjet who belongs to the city of Dep and the city of Pe, lady of the sky and the Two Lands who gives life to the good god [who pleases the heart of Re, chosen of Amun].

L'Égypte Ancienne, vol. Première Partie, To-Mehou, La Basse Égypte (Paris, 1957), 189, but it was not as important as the Hebenu of Upper Egypt.

¹⁷ The title “lord of Mesen” is considered to refer to Edfu. During the Greco-Roman Period, it was associated with Lower Egypt and referred to the north, see S. Randy (2014), The Behdetite: A Study of Horus The Behdetite From the Old Kingdom to the Conquest of Alexander, (PhD diss., University of Chicago, 2014), 270-271.

¹⁸ For original inscriptions, see Edfou I, 11.

¹⁹ aHa-anx literally means, storeroom of lived offerings, It is one of the names of the temple at Dendera, see H. Fairman (1943), Notes on the alphabetic signs employed in the hieroglyphic inscriptions of the temple of Edfu, Annales du Service des Antiquités de l'Égypte 43 (1943): 244.

²⁰ Fagt is one of the titles of the goddess Nekhbet, it might refer to the name of her temple at El-Kab. Furthermore, this word refers to one of the Osirian chapels at the temple of Dendera, see C. Sylvie, “Les Chapelles Osiriennes de Dendera: Transcription et Traduction,” Bibliothèque d'Étude 117 (1997): 18, pl. 8.

Bḥdtj nṯr ʿ3 nb pt s3b šwtj prj m 3ḥt ḥnt(j) šns Behdetite, the great god, he of multicolored plumage who appears from the horizon in front of Schenes.²¹

Bḥdty, nṯr ʿ3 nb pt nb Msn prj m 3ḥt dj(=f) ʿnh Behdetite, the great god, lord of the sky, lord of Mesen, he who emerges from the horizon and gives life.

Exterior Part

Inscriptions of the Cornice and Upper Lintel

The Cornice ←  →

The decoration of the cornice is flanked by vertical inscriptions, which read as follow (fig. 6, [1-2]).²²

The Right Side of the Cornice [vertical line] ← 



Bḥdtj nṯr ʿ3 nb pt, s3b šwtj

Behdetite, the great god, lord of the sky, he of multicolored plumage.

The Left Side of the Cornice [vertical line]  →



Bḥdtj nṯr ʿ3 nb pt, nb Msn

Behdetite, the great god, lord of the sky, lord of Mesen.

The Upper Lintel (fig. 6, [3-4]) ←  →

The Right and left Sides of the upper lintel contain the same inscriptions

²¹ *Sns* is considered to be one of the religious centers of Horus the Behdetite in the eastern region of the delta, see H. Gauthier(1925), Dictionnaire des noms géographiques contenus dans les textes hiéroglyphiques, Société Royale de Géographie d'Égypte, vol. 1 (Le Caire, 1925), 78-79; M. Pierre(1957), Géographie De L'Égypte Ancienne, vol. Première Partie, To-Mehou, La Basse Égypte (Paris, 1957), 45-46; A. Gardiner, *Ancient Egyptian Onomastica* (London, 1968), 136-137, 144. Other Egyptologists transliterate this word as *Sns* (Shenes), derived from *Sn-sw* and referring to something like “encircle it (a fish)” and thus being translated as “Fish-Pool;” see E. Bresciani,

S. El Pernigotti. Naggari, F. Silvano, *Saqqara I: Tomba di Boccari La galleria di Padineit, visir di Nectanebo I*, con un'appendice di F. Mallegni e G. Fornaciari, missioni archeologiche in Egitto (Pisa, 1980), 31.

²² Edfou I, 9.



Bḥdtj ntr 3

Behdetite, the great god.

The Two Jambs of the Door

Three vertical hieroglyphic inscriptions are carved on each side of the jambs that flanked the now missing door; they also contain dedication texts of the naos and titles of King Nectanebo II, who is the builder of this magnificent naos. It should be noted that the middle line should be read first.

Inscriptions of the Right (Western) Jamb (fig. 2) (↓)

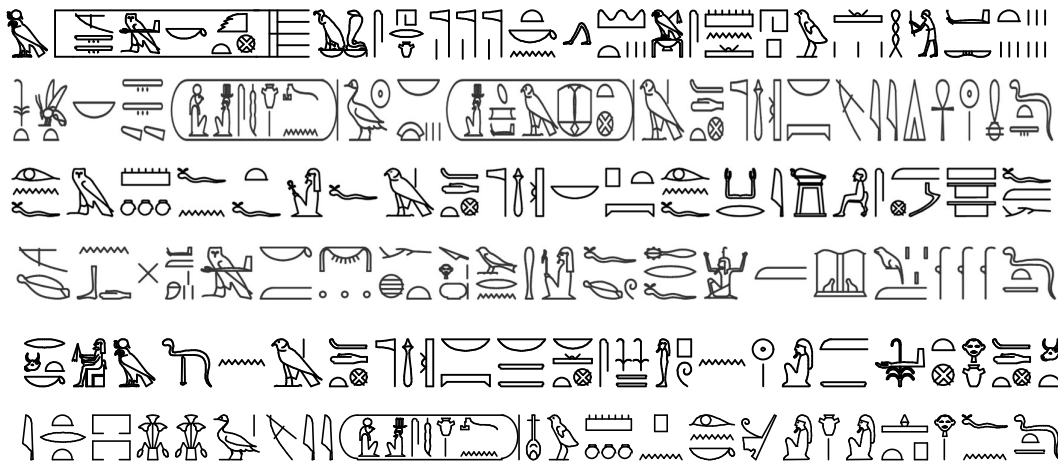

¹ | Hr [mrj t3wj, mkj kmt] Nbtj [shrj ib ntrw tkn
 ḥ3swt] ḥr nwbw [smn hpw ḥwj pdt psdt] nsw-
 bjtj nb t3wj [sndm jb R^c, stp.n Jnj ḥrt] s3 R^c nb
 ḥ^cw [Nht Hr Hbyt mrj Jnj ḥrt s3 3st] mrj Hr
 Bḥdtj ntr 3 nb pt, di ḥnh mī R^c dt

Horus [beloved of the Two Lands, protector of Egypt,] who belongs to the Two Ladies, [he who pleases the heart of the gods, Aattacker of the foreign lands,] Golden Horus, [founder of legislation, repressor of the nine bows,] king of Upper and Lower Egypt, lord of the Two Lands [who pleases the heart of Re, the chosen of Amun,] the son of Re, lord of the crowns, [beloved of Hathor, son of Amun, powerful Horus of Hbt-town,] beloved of Behdetite, the great god, lord of the sky, who gives life like Re forever.²³

² | jrj.n=f m mnw=f n jtj=f Hr Bḥdtj ntr 3 nb pt
 jr(t) n=f k3rj šps m m3t 3wj=fj m ht mrw nbd m
 ḥmtj mk m nbw ḥtj ḥr rn wr (n) ḥm=f jsw ḥr=f
 ḥḥw m ḥbw-sd ḥfnw m rnpwt dt

He made this shrine for his ancestor Behdetite, the great god, lord of the sky, He made a venerated shrine in granite, its two doors (made) in meru-wood sheathed in copper, coated with gold embossed with the

²³ Edfou I, 10, right jamb, line (1).

great name of his majesty, millions of Sed festivals and hundreds of years endlessly.²⁴

(Peace be upon you) Behdetite. Words spoken by Behdetite, the great god, lord of the sky, lord of the Two Lands, lord of Mesen: “He is the image of Re in the southern land (Upper Egypt), lord of Behdet, who takes his position at Behdet, foremost of the chapel rows of Upper and Lower Egypt. Oh, my beloved son (who pleases the heart of Re, chosen by Amun). How beautiful is this monument that you made for me!” The heart of the god is satisfied regarding him forever.”²⁵

3

dd mdw jn Hr Bhdjt ntr ʿz nb pt nb t3wj nb
Msn snn pw n Rʿ m t3-šmʿw nb Bhdjt hrj-jb Bhdjt
hnt(j) jtrtj Šmʿw Mhw s3=j mrj(=j) (sndm-jb-Rʿ-
stp.n-Jnj-hrt) nfr.wj mnw pn jrj.n=k n=j jb=j
htp(.w) hr=f n dt

Inscriptions of the Left (Eastern) Jamb (fig. 2) (↓)

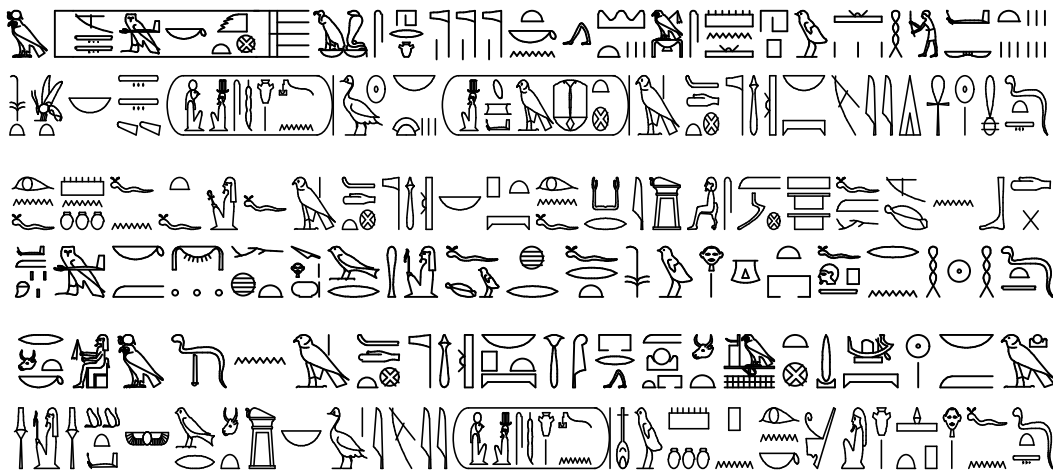

¹ Hr Mrj-t3wj-mkj-Kmt Nbtj shrj-jb-ntrw-tn-
h3swt Hr-nbw smn-hpw-hʿj-psd-psdt nsw-bjtj nb
t3wj (sndm-jb-Rʿ-stp.n-Jnj-hrt) s3-Rʿ nb hʿw
(Nht-Hr-Hbyt-mrj-Jnj-hrt-s3-3st) mrj Hr Bhdjt
ntr ʿz nb pt dj ʿnh mj Rʿ dt

Horus [beloved of the Two Lands, the protector of Egypt] who belongs to the Two Ladies [who pleases the heart of the gods. Attacker of the foreign lands,] Golden Horus, [founder of legislation, repressor the nine bows,] king of Upper and Lower Egypt, lord of the Two Lands [who pleases the heart of Re, the chosen of Amun,] the son of Re, lord of the crowns, [beloved of Hathor, son of Amun, powerful Horus of Hebet-town],²⁶

²⁴ Edfou I, 10, left jamb, line (2).

²⁵ Edfou I, 10, left jamb, line (3).

²⁶ The city of Hebet was one of the towns of the 12th nome of Lower Egypt. It was also called Pr 1b or Pr 1bt, from which its current name, Behbet el-Hagar, is derived, see H. Gauthier (1925), Dictionnaire des noms

²
 | jrj.n=f mnw=f n jtj=f Hr Bhdjt ntr ʕz nb pt jr(t)
 n=f kʕrj šps m mʕt ʕz wj=fj m ht mrw nbd m hmtj
 mk m nbw htj hr rn wr hm=f jsw hr=f rdt sw hr
 nst=f tpj tʕ r nhḥ dt

³
 | dd mdw jn Hr Bhdjt ntr ʕz nb pt sʕb šwtj prj m
 ʕht hnt(j) Wts-Hr dʕj pt rʕ-nb m Hr-ʕhtj šhm
 ʕnh šhm phtj ʕpj wr hnt(j) kʕrj nb sʕ=j mrj(=j)
 (Sndm-jb-Rʕ-stp.n-Jnj-hrtw nfr.wj mnw pn
 jrj.n=k n=j jb=j htp(.w) hr=f n dt

beloved of Horus the Behdetite, the great god, lord of the sky, who gives life like Re forever.²⁷

He made his monument for his father, Behdetite, the great god, lord of the sky. He made a glorified shrine in granite, its two doors (made) in meru-wood sheathed in copper, overlaid with gold engraved with the great name of his majesty, placing himself upon his earthly throne forever for a very long time.²⁸

Behdetite, words spoken by Behdetite, the great god, lord of the sky, foremost of Horus Edfu's throne, who crosses the sky every day as Horakhty, the living image, powerful one of mighty strength, the dignified winged beetle, foremost of every naos: "Oh, my beloved son, Senejemibre Setepeninhur (i.e., 'he who pleases the heart of Re, chosen of Amun'). How delightful is this memorial you've constructed for me! It will always satisfy my heart."²⁹

Discussion

Most Upper Egyptian naoi were discovered in temples, especially in sanctuaries.³⁰ Nectanebo II's Edfu naos was located in the middle of the holy of holies in the Ptolemaic temple, which included two other notable furnishings: the sacred processional barque of Horus, called *wiA-wts-nfrw*, and the altar, *tsw-hmt iwf*.³¹ Fragments of four naoi of king Nectanebo II's reign were found within the temple area at Elephantine.³² Also, Parts of a naos dating back to the period of Nectanebo I (380-362 B.C.E) were discovered with a pile of blocks inside the narthex located at the northwest corner of the White Monastery Church at Sohag.³³

The naos of the White Monastery is made of light grey granite. It is 61 cm tall and 35 cm wide. The preserved decorations indicate that this fragment is the right jamb of a small naos; the gods on the interior surface look out (right), while the king on the exterior surface presents and offers

géographiques contenus dans les textes hiéroglyphiques, Société Royale de Géographie d'Égypte, vol. 1 (Le Caire, 1925), 24.

²⁷ Edfou I, 10, left jamb, line (1).

²⁸ Edfou I, 10, right jamb, line (2).

²⁹ Edfou I, 10, right jamb, line (3).

³⁰ Recently, A great discussion was made by Heimo Hohneck on Upper Egyptian Naoi. he does in fact discuss all known naoi from Upper Egypt in detail. For more details, please check his unpublished PhD dissertation: H. Hohneck, Naoi - Königliche Steindenkmäler in den Tempeln Ägyptens: Vom Alten Reich bis zum Ende der pharaonischen Ära, unpublished dissertation, Johannes Gutenberg-Universität Mainz, 2020, Band II, Doc. 118, <http://doi.org/10.25358/openscience-5369>

³¹ P. Delia (1992), Ancient Egypt: Architectural Guide for Travelers (California, 1992), 121.



³² N. Spencer (2006), A Naos of Nekhthorheb from Bubastis: Religious Iconography and Temple Building of the 30th Dynasty, (London, 2006), 65.

³³ D. Klotz (2011), A Naos of Nectanebo I From the White Monastery Church, (Sohag), Göttinger Miszellen 229 (2011): 39, figs, 1-9).

while facing the divinities within the naos (fig. 7).³⁴ Unfortunately, the absence of any additional decoration precludes any discussion of their function or architectural context.

At Abydos, a red granite naos of king Nectanebo II was discovered inside the region of the western temple which originally dates to the reign of king Nectanebo I, 30th Dynasty (fig. 8).³⁵ Abydos naos is now exhibited at the Egyptian Museum (CG70018).³⁶ It is 136 cm high and 86 cm deep. On the left hand, (*nḥt nb.f*) offers an image of Ma'et to Thoth as a baboon, and Onuris-Shu offers an image of Ma'et to Osiris-Onnophris.³⁷ The deity *ini-hr-šw* (son of the sun, lord of the sky) presents the image of Ma'et to Osiris of the west, who, in return, gives "all life and power, all health". While the right side has a similar scene, for King Nectanebo II (*nḥt hr ḥbt*) offers the same offering to God Thoth, who takes the place of God Osiris here. The king presents Ma'et to his father, additionally giving him the '*t3-nḥ*' (kind of bread), during the ceremony in which the God presents the sign of life in front of the pharaoh, which is supposed to be a sign of eternal life. Thoth appears as a baboon. It's called "prince (*hrp*) or type (*hm*)" (knew) Gods, Lord of the skies, great God.

Thus, there seems to be a relation between the location of the naos and its primary function. All of the 30th Dynasty naoi were considered holy elements of their temples, especially in the sanctuary. Most were constructed to house the cult statue of the deity, or sometimes a mummified sacred animal. Statements on the left and right jambs of the Edfu naos (*nfr.wy mnw pn ir.n.k n.i, ḥtp ib.i hr=f n dt*) and (*nfr.wy mnw pn ir.n.k n.i, ib ntr ḥtp hr=f n dt*) indicate that the king built it to achieve the eternal satisfaction of the heart of Horus, when the god entered the naos during the night hours and spread his wings over it for protection.³⁸

Most of the 30th Dynasty naoi discovered in Upper Egypt were dedicated to the main gods worshiped in the temples in which they were found (table. 2). The naos of Edfu was dedicated to Behdetite, the central god of Edfu; the naos of Abydos was dedicated to three chief gods (Thoth, Hathor, and Onuris-Shu);³⁹ Nectanebo I's naos in Sohag's White Monastery Church was dedicated to two gods, Wepwawt , *wpw3wt ht mrḥ*, Wepwawt: varnished wood,⁴⁰ and Khnum , *šnmw ht nbw*, Khnum: gilded wood.⁴¹ The naos of Koptos was dedicated to the chief deity of its city, Min, as is shown clearly by its dedication text, *ir.n.f mnw.f n it.f*

³⁴ D. Klotz (2011), A Naos of Nectanebo I From the White Monastery Church, (Sohag), Göttinger Miszellen 229 (2011): 39.

³⁵ A. Mariette (1880), Catalogue Général des Monuments d'Abydos Découverts Pendant Les Fouilles de Cette Ville (Paris, 1880), 252 [1424]; G. Roeder, "Naos," in Catalogue général des antiquités égyptiennes du Musée du Caire (1914), Nos 70001–70050 (Le Caire, 1914), 53.

³⁶ Roeder, Naos, CGC, 53-55.

³⁷ F. Petrie., Abydos II, pl.42c.

³⁸ S. Randy (2014), The Behdetite: A Study of Horus The Behdetite From the Old Kingdom to the Conquest of Alexander, (PhD diss., University of Chicago, 2014), 268.

³⁹ N. Spencer (2006), A Naos of Nekhthorheb from Bubastis: Religious Iconography and Temple Building of the 30th Dynasty (London, 2006), 65.

⁴⁰ C. Sylvie (1987), Les Statues Cultuelles de Dendara d' Après Les Inscriptions Parietales, Bulletin de l'Institut Français d'Archéologie Orientale 87 (1987): 73-74; C. Kara(2007), The Cost of Death: The Social and Economic Value of Ancient Egyptian Funerary Art in the Ramesside Period, Egyptologische Uitgaven 22 (2007): 37-38.

⁴¹ D. Klotz (2011), A Naos of Nectanebo I From the White Monastery Church (Sohag), Göttinger Miszellen 229 (2011): 39-40.

Table 2—Survey on the 30th Dynasty naoi found in Upper Egyptian temples (N. Spencer, A Naos of Nekhthorheb from Bubastis: Religious Iconography and Temple Building of the 30th Dynasty (London, 2006), 64-65, Appendix. 4).

Site	Reign	Location	Material	Dedication	Size: H x W x D (m)	Roof Type	Architecture	Decoration
Elephantine	Nectanebo II	On site	Red granite	-	4.4 x 2.27	pyramidal	Torus molding at sides, cornice, ledge. Two levels inside.	Unfinished
Elephantine	Nectanebo II	On site	Granodiorite	Khnum-Ra	3.66 x 2.15	pyramidal	Simple walls. Two levels inside	Unfinished
Elephantine	Nectanebo II	On site	Black diorite	-	-	pyramidal	Cavetto cornice, torus moldings	Small fragments survive
-	Nectanebo II	Florence, Gaddiano Museum	-	-	-	pyramidal	-	Titular on preserved fragment
Edfu	Nectanebo II	On site	Black granite	Horus the Behdetite	4.17 x 2.2	pyramidal	Lintel, torus molding, stepped interior	Inscriptions on door jambs Heraldic; plants in the back of the cavity, as well as solar birds on the cavity ceiling
Koptos	Nectanebo I	Cairo Museum, CG 70017	Green slate (grey wacke?)	Min of Coptos	2.18 x 0.95 x 0.86	pyramidal	Cornice, torus moulding, ledge, and a shallower cavity base	Inscription on doorjambs only; decorated lintel
Sohag (Deir)	Nectanebo I	On site	Light grey granite	Wepwawet and Khnum	0.61 x 0.35	-	Lintel, torus molding, stepped interior	Inscription on doorjambs; and decorated lintel
Abydos	Nectanebo I & Nectanebo II	Cairo Museum, CG 70018	Red granite	Hathor, Thoth, and Onuris-Shu(?)	-	Curved	-	Large offering scenes (exterior and interior)
Abydos	Nectanebo II	Cairo Museum, CG 70017	Red granite	-	1.3	-	-	Inscription on the doorjamb, pharaoh offering, and heraldic plants at the bottom

Min *gbꜣt nb* (“It was for his father, Min of Coptos, lord of Panopolis [Akhmim] that he built as his memorial”).⁴² Thus, it is evident that most of the Upper Egyptian naoi dedicated during the 30th Dynasty were established for the worship of local deities in the various religious centers of the region.

Examination of the material from which the naoi are constructed reveals a variety of stones, including red granite, light gray granite, green slate, and black syenite (table. 2). It is no accident that the material used for most of the Upper Egyptian naoi is granite,⁴³ which would have been easy to transport from the quarries at Aswan to Abydos, Sohag, and Edfu. The naos discovered at Qeft (Coptos) (fig. 9) was made of green slate or metagraywacke,⁴⁴ a stone quarried in the nearby Wadi Hammamat.⁴⁵ There is, thus, a robust relationship between the location of discovery and the material used to create each naos.⁴⁶ In sum, this evidence suggests that, during the 30th Dynasty, the Egyptians used stone from local quarries to save time and effort. It also implies a connection between the local region and the local god, as well as their control over resources and identification with specific materials.

Most of the naoi were constructed in a vertically rectangular shape to house the cult statue. Regrettably, as already noted, most have been discovered incomplete (and for that reason most of them have only estimated proportions). Most of the selected naoi have a pyramidal roof.⁴⁷ But various roof styles appeared during the Late Period with more decorative architectural elements. Spencer has observed that a frieze of uraei tops most flat and curved roofs on naoi, but this ornamentation is not frequently found in association with pitched or pyramidal roofs.⁴⁸

⁴² G. Legrain (1905), Notes D'Inspection, Annales du Service des Antiquités de l'Égypte 6 (1905): 122-123; G. Roeder, Naos,” in Catalogue général des antiquités égyptiennes du Musée du Caire, Nos 70001–70050 (Le Caire, 1914), 55-57; H. Gauthier (1925), Dictionnaire des noms géographiques contenus dans les textes hiéroglyphiques, Société Royale de Géographie d'Égypte, vol. 1 (Le Caire, 1925), 187.

⁴³ Granite is a kind of igneous rock. Its color appears as reddish to mainly pinkish; it is very coarse, commonly porphyritic, and occasionally gneissoid, see J. Harrell (2013), Ornamental Stones, in UCLA Encyclopedia of Egyptology 1(1), ed. Willeke Wendrich (Los Angeles, 2013), 2. It was used from Early Dynastic to Roman Periods. It was quarried from many sites in Aswan and Nile Valley. Its ancient names were (Egyptian) mAT, inr n mAT, inr nfr n mAT, and mAT Abw; (Greek) lithos pyrrhopoecilos; (Latin) lapis Aethiopicus, lapis Syenites, and lapis Thebaicus. The geologically false name is syenite, see J. Harrell, “Ornamental Stones,” in UCLA Encyclopedia of Egyptology 1(1), ed. Willeke Wendrich (Los Angeles, 2013), 2.

⁴⁴ J. Harrell & P. Storemyr, “Ancient Egyptian quarries—An illustrated overview, in Quarry Scapes: Ancient stone quarry landscapes in the Eastern Mediterranean, ed. A. Nizar, B. Elizabeth, D. Patrick, & H. Tom (2009), Geological Survey of Norway, Special Publication 12 (Norway, 2009), 12-48.

⁴⁵ J. Harrell & P. Storemyr (2009), Ancient Egyptian quarries—An illustrated overview, in Quarry Scapes: Ancient stone quarry landscapes in the Eastern Mediterranean, ed. A. Nizar, B. Elizabeth, D. Patrick, & H. Tom, Geological Survey of Norway, Special Publication 12 (Norway, 2009), 18-20, fig. 11 [H28a].

⁴⁶ D. Arnold (1991), Building in Egypt: Pharaonic Stone Masonry (Oxford, 1991); B. Elizabeth (2010), “Quarrying, and mining (stone), in UCLA Encyclopedia of Egyptology 1(1), ed. Willeke Wendrich (Los Angeles, 2010), 1-17, <http://digital2.library.ucla.edu/viewItem.do?ark=21198/zz0026jkd5>

⁴⁷ N. Spencer (2006), A Naos of Nekhthorheb from Bubastis: Religious Iconography and Temple Building of the 30th Dynasty (London, 2006), 65.

⁴⁸ N. Spencer (2006), A Naos of Nekhthorheb from Bubastis: Religious Iconography and Temple Building of the 30th Dynasty (London, 2006), 1.

At the time of its discovery, the orientation of the Edfu naos differed from that of Edfu temple.⁴⁹ In general, most Egyptian temples followed the east-west axis until the end of the 30th Dynasty. This followed the theological concept of the temple as an embodiment of the universe, starting from the east, where the sun rises and attests to the victory of the King over his enemies, which is depicted upon the exterior faces of outer pylons. The sun then passes through the temple from the courtyard to inner parts, after which it rests in the west, where the god entered the holy of holies for the night hours. However, temples dating to the Greco-Roman period have different axis (south-north),⁵⁰ perhaps to imitate the geographical nature of Egypt: the Nile River flows through Egypt from the south, place of the hot sun (the temple’s open court), to the Delta, place of the cooler marshes of the north (the sanctuary and chapels). Therefore, the east-west orientation of the naos is considered to be physical evidence that the original orientation of the temple, too, was east-west, in the usual manner of temples from the New Kingdom to the 30th Dynasty.⁵¹

Symbolic imagery was used extensively throughout Egyptian history. The symbols were painted on papyrus, funerary reliefs, sarcophagi, gemstones, amulets, obelisks, and the walls of temples and palaces, and they served as decoration as well as spiritual, religious, and magical functions.⁵² A symbol signifies something other than its inherent nature. They are generally based on widely accepted definitions. However, unlike mathematical symbols, which stand for something very concrete, symbols usually stand for something more invisible or intangible than the symbols themselves.⁵³ Many symbols exist today, such as the cross in Christianity and the crescent in Islam. On the inner lintel, there are representations of the winged sun disc (*hpy*), a mountain (*dw*), two protective uraei, the so-called (*šn*), the sign of eternity, and the representation of an (*hw*) feather. According to these depictions, the naos played a religious role in the sanctuary because it comprises many images that reflect religious meanings and symbolism (Table. 3).

Table 3—Symbolism of the signs in the inner lintel

Sign	Sign Code	Transliteration	Meaning	Symbolism
Ω	N89	šn	Shen is a rope circle tied into an unbroken circle that represents perfection, infinity, and protection. The name is derived from	The <i>Shen</i> sign symbolizes protection

⁴⁹ S. Randy (2014), The Behdetite: A Study of Horus The Behdetite From the Old Kingdom to the Conquest of Alexander, (PhD diss., University of Chicago, 2014), 271.

⁵⁰ C. Leben, (1990), Bemerkungen zum Horustempel des Neuen Reiches in Edfu, Bulletin de la Société d’Égyptologie 14 (1990): 65-67.

⁵¹ B. Alexander (1968), A History of Egyptian Architecture, vol. 3 (California, 1968), fig. 111; M. Shaltout & J. Belmonte, (2005), On the Orientation of Ancient Egyptian Temples, 1, Upper Egypt and Lower Nubia, Journal for the History of Astronomy 36 (2005): 273, table. 1, <https://doi.org/10.1177/002182860503600302>.

⁵² Ana Ruiz(2012), The Spirit of Ancient Egypt ,(Algora Publishing, 2001), 137.

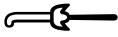

⁵³ Suzette Hartwell, Keeping up Appearances: Beauty, Ageing and Realism and Its Symbolism in Art and Literature in Ancient Egypt (Manchester: The University of Manchester, 2008), 5, <http://hdl.handle.net/1959.14/90629>; Zeinab Feisal Abdel Kader(2012),REFLECTIONS OF NUMBER SYMBOLISM ON EGYPTIAN SACRED ARCHITECTURE,” *ERJ. Engineering Research Journal* 35, no. 3 (July 1, 2012): 265–73, <https://doi.org/10.21608/erjm>, 2012.67177.

			the Egyptian word for "circle." Shen amulets are commonly worn for protection, and Shen statues are commonly displayed on a stand resembling the Greek Omega, but this "stand" is understood to be a knotted rope completing a circle. ⁵⁴	and completion. ⁵⁵
	N29	<i>dw</i>	The sign depicts two mountain peaks. It was of great cosmic significance to the ancient Egyptians. In ancient Egyptian concepts, the mountains usually supported the heavens. The Egyptians envisioned a universal mountain that supported the heavens, with a western peak (<i>Manu</i>) and an eastern peak (<i>Baku</i>). The edge of this massive earth mountain was sometimes depicted as part of the cosmic mountain, guarded by lion gods who watched over the rising and setting sun. ⁵⁶	The <i>djw</i> sign symbolizes support.
	S37	<i>hw</i>	Throughout Egyptian history, feathers have been seen in both utilitarian and ritual contexts, adorning crowns, and personifying deities. used to classify ethnic groups Feathers are mostly known from	The <i>khw</i> sign symbolizes truth.

⁵⁴ Joshua J. & Mark (2022), "Ancient Egyptian Symbols," World History Encyclopedia, accessed November 3, 2022, <https://www.worldhistory.org/article/1011/ancient-egyptian-symbols/>.

⁵⁵ Ruiz, *The Spirit of Ancient Egypt*, 139–40.

⁵⁶ Ian Shaw & Paul T. Nicholson (2003). *The Dictionary of Ancient Egypt*. Rev. and updated *pbk.* ed (London: Harry N. Abrams, 2003), 20–21.

			depictions and examples found in tombs. Feathers may be a distinguishing feature of gods such as Behdety, a form of Horus of Edfu represented by a winged disc, whose epithet is <i>sꜣb-šwt</i> “dappled feather.” ⁵⁷ The king or members of the royal family wore a tall, elongated fan (<i>bht/hw qr hwyt</i>) made from a single ostrich feather as a mark of rank. ⁵⁸	
	H5A	<i>hpy</i>	Temple doors were often carved with winged sun discs. When placed above a Pharaoh's name, it means he won. In commemoration of this event, ordered a winged sun disc to be placed at the entrance of every temple in Egypt to protect against enemies. ⁵⁹	The <i>Khpy</i> sign symbolizes protection.
	I58, I63	<i>rnn-wtt, špst</i>	Uraeus, an upright cobra made to wear as a headdress or crown, is a symbol of Egyptian royalty. The fire-breathing symbol associated with the goddess <i>Wajit</i> both protected and supported the king's destructive power. It was a developing image. This image appears on a variety of protective	The <i>Uraeus</i> sign symbolizes royalty and power.

⁵⁷ Emily Teeter, “Feathers(2010),UCLA Encyclopedia of Egyptology 1, no. 1 (September 25, 2010): 1, <https://escholarship.org/uc/item/4737m1mb>.

⁵⁸ Theodore M. Davis(1907), *The Tomb of Louiva and Touiyou: The Finding of the Tomb* (London: A. Constable and Co., 1907), fig. 36, <http://archive.org/details/tomboflouiyatoui03davi>; Teeter, “Feathers,” 5.

⁵⁹ Ruiz, *The Spirit of Ancient Egypt*, 141.

			amulets, crowns, and statues. ⁶⁰	
--	--	--	---	--

The artist was creative in using the space for the texts and figures on the naos. As Sylvie Cauville has said, the work of the architect and scribe took place in a framework of cooperation and integration.⁶¹ In the naos at Edfu, the artist was able to portray the three forms of Horus the Behdetite that represent the phases of the sun and also incorporate two additional figures of Nekhbet and Wadjet to symbolize Upper and Lower Egypt. The artist inscribed the texts as three vertical lines on each jamb, the middle line dealing with the royal titles, and the outer one presenting the monuments that were dedicated by the king to Horus the Behdetite, with emphasis on the naos itself. The third line starts with an opening phrase *r hnt.k*, which means “peace be upon you,” which some other scholars translate as “life to your nose;”⁶² this phrase is followed by the god’s titles. The previous description, in fact, refers to the religious significance of the naos to the king.

The artist depicts three forms of Horus the Behdetite indicating the phases of the sun, as well as two supplementary figures representing Upper and Lower Egypt, *Nekhbet* and *Wadjet*. Below is a table that concludes the relation between the king and the deities who appeared on the naos walls and its inscriptions (Table 4).

Table 4—Deities who had been mentioned in the naos and their titles, location, and duties.

Deity	Location	Titles	Role
<i>Behdetite</i>	The Inner Ceiling (west)	<ul style="list-style-type: none"> - <i>ntr ʿ3 nb pt s3b šwt prj m 3ht(j) hnt(j) štyt šmʿw hnt(j) Ndm ʿnh</i> - <i>šwtj prj m 3ht hnt(j) hbnw</i> - <i>nb Msn</i> 	<ul style="list-style-type: none"> - The great god, lord of the sky, he of colorful plumage who appears from the horizon in front of the southern chapel that located before Nedjem-ankh (Dendera). - who emerges from the horizon first and foremost of the city of Hebenu. - lord of Mesen

⁶⁰ William Ricketts Cooper(1873), The Serpent Myths of Ancient Egypt: Being a Comparative History of These Myths Compiled from the “Ritual of the Dead, Egyptian Inscriptions, Papyri, and Monuments in the British and Continental Museums (Robert Hardwicke, 1873).

⁶¹ C. Sylvie & D. Devauchelle (1984), Les Mesures Reelles du Temple d’Edfou 1, Bulletin de l’Institut Français d’Archéologie Orientale 84 (1984): 29.

⁶² S. Randy (2014), The Behdetite: A Study of Horus The Behdetite From the Old Kingdom to the Conquest of Alexander, (PhD diss., University of Chicago, 2014), 268.

	The Inner Ceiling (east)	<ul style="list-style-type: none"> - <i>štjt Mḥw ḥnt(j) ḥ^ϵ(w)-^ϵnh</i> - <i>prj m ʒht ḥnt(j) šns</i> 	<ul style="list-style-type: none"> - He is the foremost of the northern chapel in front of (Dendera). - He appears from the horizon in front of Schenes.
	The cornice	<ul style="list-style-type: none"> - <i>Bḥdtj nṯr ʕʒ nb pt, sʒb šwtj</i> - <i>nb Msn</i> 	<ul style="list-style-type: none"> - The great god, lord of the sky, he of multicolored plumage. - Lord of <i>Msn</i>.
	The upper lintel	<ul style="list-style-type: none"> - <i>Bḥdtj nṯr ʕʒ</i> 	<ul style="list-style-type: none"> - Behdetite, the great god.
	The western jamb	<ul style="list-style-type: none"> - <i>Msn snn pw n R^ϵ m tʒ-šm^ϵw nb Bḥdt ḥrj-jb Bḥdt ḥnt(j) jtrtj Šm^ϵw Mḥw</i> 	<ul style="list-style-type: none"> - lord of Mesen: “He is the image of Re in the southern land (Upper Egypt), lord of Behdet, who takes his position at Behdet, foremost of the chapel rows of Upper and Lower Egypt.
	The eastern jamb	<ul style="list-style-type: none"> - <i>Bḥdtj nṯr ʕʒ nb pt sʒb šwtj prj m ʒht ḥnt(j) Wts-Hr dʒj pt r^ϵ-nb m Hr-ʒhtj shm ^ϵnh shm pḥtj ʕj wr ḥnt(j) kʒrj nb</i> 	<ul style="list-style-type: none"> - The great god, lord of the sky, foremost of Horus Edfu's throne, who crosses the sky every day as Horakhty, the living image, powerful one of mighty strength, the dignified winged beetle, foremost of every naos
<i>Nekhbet</i>	The inner ceiling (west)	<ul style="list-style-type: none"> - <i>Nḥbt ḥdt Nḥn</i> 	<ul style="list-style-type: none"> - Nekhbet, the White One of Nekhen, she gives life and authority.

	The inner ceiling (east)	- <i>nb(t) f'gt</i>	- lady of Faget-city.
Wadjet	The inner ceiling (west)	- <i>Wzđjt P p nb(t)</i>	- Wadjet of Dep and the city of Pe, she gives birth to the king.
	The inner ceiling (east)	- <i>đi(=s) 'nh n ntr nfr</i>	- She gives life to the good god [the king].

Inside the naos, the god Horus the Behdetite unites with his cult statue, where he feels stable and happy, having reached his resting place. After the union of the god with his cult figure within the naos, the deity is facing a scene that is depicted on the inner lintel. This scene represents the sunset with two wings stretching down as a symbol of the evening and darkness during which Horus the Behdetite shuts his eyes and sleeps. It is astonishing to find that an artist reused this scene during the Ptolemaic period in the same place, but this time upon the inner lintel of the sanctuary itself.⁶³ These depictions support the theory that both the holy of holies and the naos are the resting place of Horus the Behdetite. Then the god wakes up again as one of the manifestations of the sun and shines in the form of the beetle in the temple of Edfu. As mentioned in the text of the ceiling of the naos, *Hr Bđdy, ntr 'z nb pt, s'zb šwt pr m šht hnt štyt šm't hnt Nđm 'nh*, “Horus the Behdetite, the great god, lord of the sky, he of multicolored plumage, who comes forth from the horizon in front of the southern chapel before Nejemankh (Dendera).”

There is no doubt that Horus the Behdetite shines in two primary centers of his worship, following the texts of the ceiling of the naos that indicate the rebirth of Horus the Behdetite in two cult centers, lbn and ant. The purpose of this is to express the northern and southern shining of the god. After the deity's resurrection, he feels happy when he begins the process of receiving his temple, which was built by the king for him, as is shown clearly through the phrase *st wrt hws n m'zwt gm.f*, “he (i.e., Horus the Behdetite) finds his great place was built again.” The city of Edfu was considered the secret place and the physical manifestation of the dark horizon where Horus the Behdetite came forth every day to join with not only his cult statue inside the naos but also all depictions of him on the inner walls of the sanctuary.⁶⁴

Conclusion

In conclusion, the current paper has dealt with the naos discovered in Upper Egypt, with particular emphasis on the naos of King Nectanebo II at Edfu, a milestone in the building program of the 30th Dynasty. The manuscript introduced new religious insights into this naos by examination of its texts and scenes, which has illuminated in detail its architectural elements and explored its function within the temple, as well as the religious meaning behind the reliefs.

⁶³ P. Wilson, (2010), Temple Architecture and Decorative System, in A Companion to Ancient Egypt 1, edn. B. Alan (Oxford, 2010), 797.

⁶⁴ A. Gardiner (1994), Horus the Behdetite, Journal of Egyptian Archaeology 30 (1944): 44-46; W. Helck & E. Otto (1980), Tell Edfu.” in Lexikon der Ägyptologie 5, edn. Wolfgang Helck and Wolfhart Westendorf, (1980), 323-326.

Besides, the paper focused on some main points which are the core findings of the study as follow: (1) During the 30th Dynasty, the majority of Upper Egyptian naoi were established for the worship of local deities in Egypt's various religious canthers. (2) To save time and effort, the Egyptians used stone from local quarries. It also suggests a relationship between the local region and the local god, in addition to their control over resources and identification with specific materials. (3) The east-west orientation of the naos is assumed to be physical evidence that the temple's original orientation was also east-west, as was typical of temples from the New Kingdom to the 30th Dynasty. (4) The artist was able to depict the three forms of Horus the Behdetite that represent the phases of the sun in the naos at Edfu, as well as two additional figures of Nekhbet and Wadjet to represent Upper and Lower Egypt. (5) The large number of inscriptions on the naos refers to its religious significance to the king, as King Nectanebo II built it to achieve the eternal satisfaction of Horus' heart, when the god entered the naos during the night hours and spread his wings over it for protection. (6) Finally, the depictions of the naos support the theory that both the holy of holies and the naos are the final resting place of Horus the Behdetite. The god then reignites as one of the sun's manifestations and shines in the form of a beetle in the temple of Edfu. However, there is no doubt that Egyptian naoi require additional study, perhaps a documentation project dedicated to this important architectural form.

Acknowledgements

The authors would like to express their deepest appreciation to Wazir Abdelwahab, Rasha Omran, Tamer Fahim, Pearce Paul Creasman, Noreen Doyle, Magdi Koutkat, Raghda El-Behaedi, Tierney Harris, Mina Sami, and Johnathan Whisenant for their advice and assistance in the preparation of this paper.

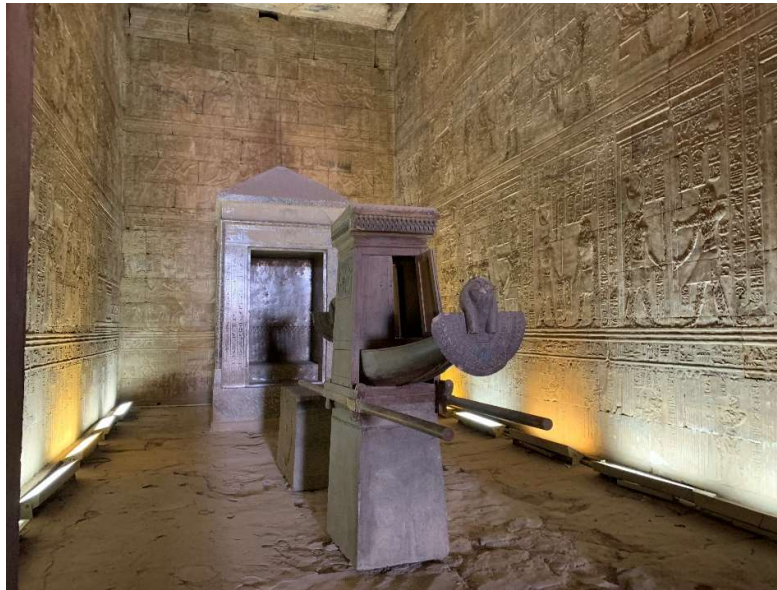

Figure 1—The location of the Naos of King Nectanebo II inside the Edfu Temple's sanctuary (photograph courtesy of Raghda El-Behaedi).

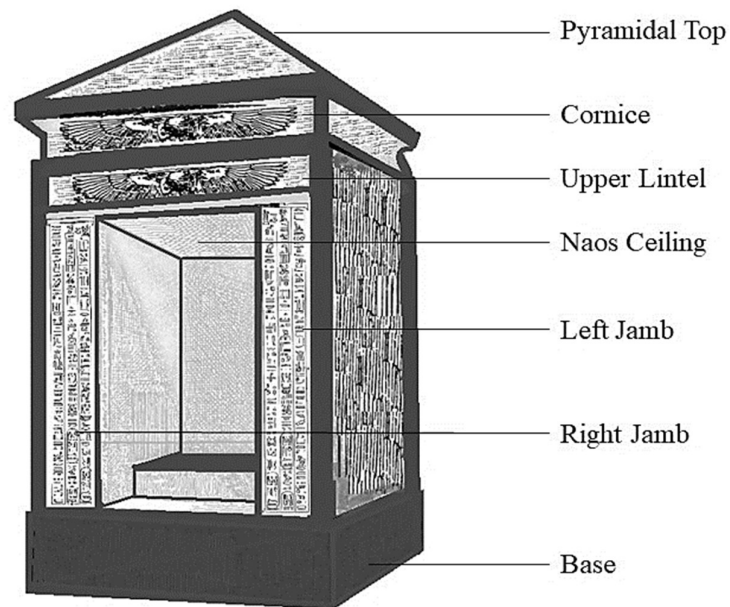

Figure 2—Elements of the Naos (edited by the authors, after *Edfou I*, 9, fig. 2).

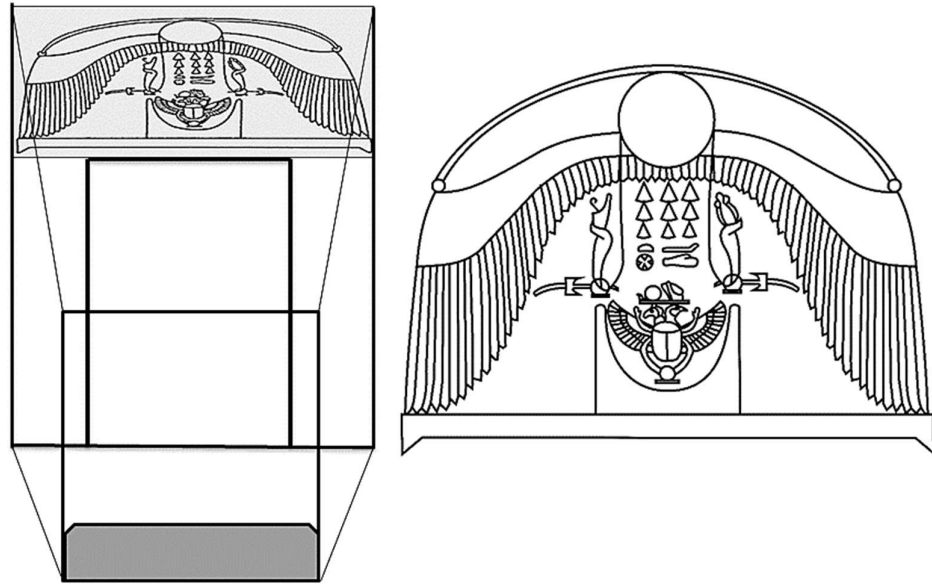

Figure 3—(right) the location of the inner lintel, (left) the inner lintel of the Naos shows the image (*hpy*) of the winged sun disk (designed by Eslam Salem and Mina Sami).

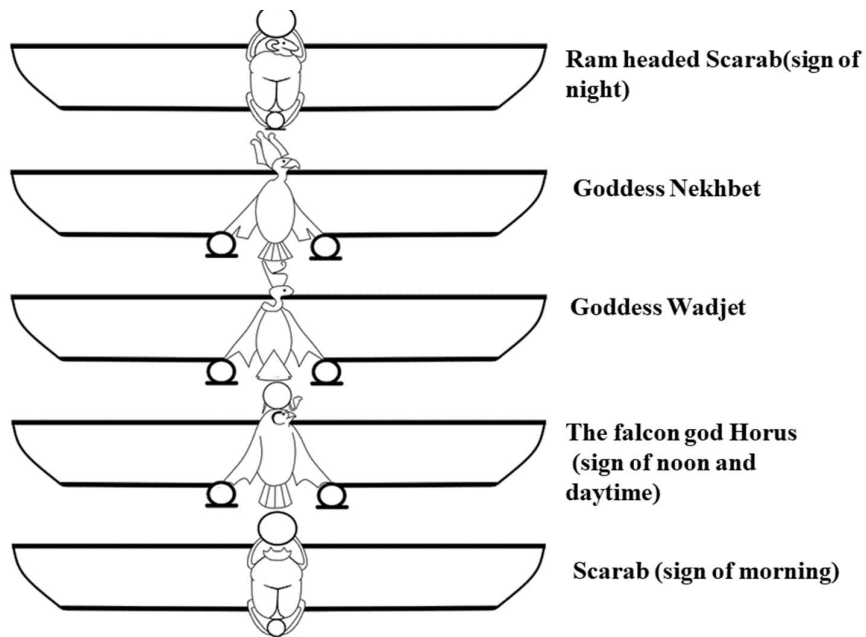

Figure 4—The representations of the sun during the day upon the naos ceiling (designed by Tierney Harris).

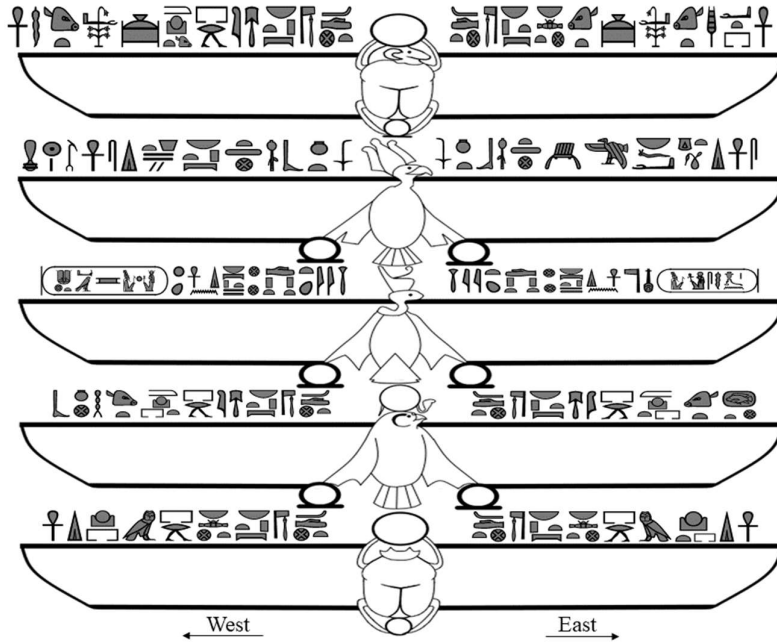

Figure 5—The distribution of the hieroglyphic inscriptions of the ceiling (designed by Tierney Harris; inscriptions by Eslam Salem).

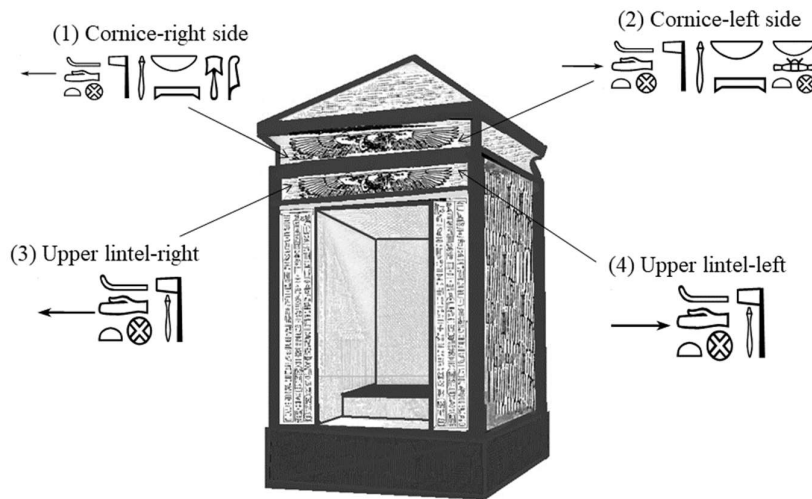

Figure 6—The hieroglyphic inscriptions on the cornice and the upper lintel (edited by the authors, after *Edfou I*, 9, fig. 2).



Figure 7—A part of naos fragments of king Nectanebo I From the White Monastery Church, Sohag (k. David., A Naos of Nectanebo I From the White Monastery Church (Sohag), 2011, 45, fig. 1).



Figure 8—Naos of king Nectanebo II, discovered in Abydos, Egyptian Museum (after Saleh and Sourouzian no. 257, 1987).

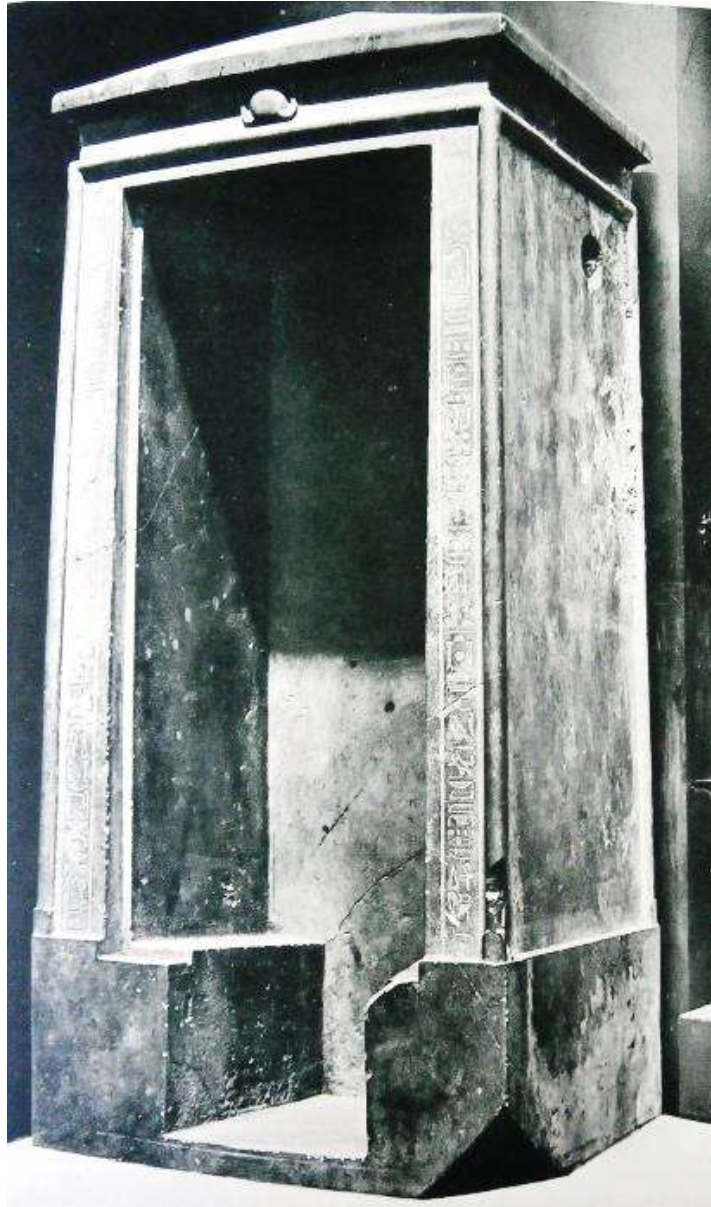

Figure 9— Naos of Nectanebo at Coptos (after Roeder, Naos, CGC, pl.15, 1914).

ما وراء الناووس: إعادة النظر في ناووس إدفو

طاهر عبد الحميد، إسلام سالم

قسم الارشاد السياحي، كلية السياحة والفنادق، جامعة الفيوم

المستخلص

تهدف هذه الدراسة إلى إعادة النظر في ناووس العصر المتأخر، ولا سيما ناووس إدفو. خلال الأسرة الثلاثين، بدأ الملك نختنبو الأول موجة من أنشطة البناء الهامة في جميع أنحاء مصر، وبعد ذلك أكمل الملك نختنبو الثاني هذا الجهد. من بين الآثار التي شيدت كانت ما يعرف بالناووس، أو الأضرحة المقدسة التي تضم تمثال عبادة للإله المحلي خلال الاحتفالات الدينية. من بين المواد المستخدمة في صنع الناووس كانت الجرانيت الأحمر والجرانيت الرمادي الفاتح والأردواز الأخضر والسيانيت الأسود. غالبًا ما كان الخشب يستخدم أيضًا كأحد مواد الصنع، إما لكامل الناووس أو لأحد أجزائه. من الجدير بالذكر أن غالبية الناووس التي لا تزال موجودة هي تلك المصنوعة من الحجر. لسوء الحظ، اختفت تلك المصنوعة من الخشب بالكامل تقريبًا. ركزت معظم الدراسات السابقة عن الأسرة الثلاثين على تلك الخاصة بالوجه البحري، مما أدى إلى نقص في البحث المتعمق عن معاصريهم في صعيد مصر. في محاولة لإصلاح هذه الفجوة، تحتوي الدراسة الحالية على فحص شامل لناووس الملك نختنبو الثاني الموجود في إدفو. يعتبر أقدم عنصر في المعبد، ويحتل الجزء الأوسط من قدس الأقداس ويقدم دليلًا ماديًا على اتجاه المعبد الذي بدأ من عصر الدولة الحديثة حتى نهاية الأسرة الثلاثين. تعكس النصوص على الناووس الدور الديني للناووس من خلال ذكر مراكز العبادة الخاصة بالمعبودات التي ذكرت على نقوش الناووس. تقدم هذه الورقة البحثية إعادة النظر لناووس معبد أدفو وذلك لإلقاء الضوء على هذا النوع من العمارة ودوره ووظيفته في معابد العصر المتأخر، مع النظر بشكل خاص إلى موقعه داخل المعبد، ومواد البناء، والتصميم المعماري، والرمزية الزخرفية، والمفاهيم الدينية الكامنة وراء النصوص.

الكلمات الدالة

الناووس - الأسرة الثلاثين - العصر المتأخر - نختنبو الثاني - إدفو

References

- Adolf, E. & Hermann, G. (1971), Wörterbuch der ägyptische Sprache, zweiter band (Berlin, 1971).
- Alexander, B. A. (1968), History of Egyptian Architecture, vol. 3 (California, 1968).
- Annie, F. (2018), Nectanébo: La dernière dynastie égyptienne, (Paris: Khéops 2018).
- Arnold, D. (1991), Building in Egypt: Pharaonic Stone Masonry, (Oxford, 1991).
- Arnold, D. (1999), Temples of the Last Pharaohs (New York/Oxford, 1999).
- Bresciani, E. S., El Pernigotti, Naggar, F. & Silvano, (1980), Saqqara I: Tomba di Boccari La galleria di Padineit, visir di Nectanebo I, con un'appendice di F. Mallegni e G. Fornaciari, missioni archeologiche in Egitto (Pisa, 1980).
- Burgos, F.L., François & Grimal, N. (2006), La chapelle rouge: Le Sanctuaire de Barque d'Hatshepsout, Fac-similés et photographies des scènes, vol. 1 (Paris, 2006).
- Cléré, J. (1951), A Propos de L'ordre de Succession des Rois de la XXXth Dynastie, Revue d'Égyptologie 8 (1951).
- Cooper & William Ricketts (1873), The Serpent Myths of Ancient Egypt: Being a Comparative History of These Myths Compiled from the "Ritual of the Dead", Egyptian Inscriptions, Papyri, and Monuments in the British and Continental Museums, Robert Hardwicke, 1873.
- Davis, Theodore M. (1907), The Tomb of Iouiya and Touiyou : The Finding of the Tomb. London: A. Constable and Co.
<http://archive.org/details/tombofiuiyatoui03davi> .
- Delia, P. (1992), Ancient Egypt: Architectural Guide for Travelers (California, 1992).
- Elizabeth, B. (2010), Quarrying, and mining (stone), in UCLA Encyclopedia of Egyptology 1(1), ed. Willeke Wendrich (Los Angeles, 2010):1-17,
<http://digital2.library.ucla.edu/viewItem.do?ark=21198/zz0026jkd5>
- Fairman, H. (1943), Notes on the alphabetic signs employed in the hieroglyphic inscriptions of the temple of Edfu, Annales du Service des Antiquités de l'Égypte 43 (1943).
- Gardiner, A. (1944), Horus the Behdetite, Journal of Egyptian Archaeology 30 (1944).

Gardiner,A.(1968), Ancient Egyptian Onomastica, (London, 1968).

Gauthier, H. (1925) Dictionnaire des noms géographiques contenus dans les textes hiéroglyphiques, Société Royale de Géographie d'Égypte, vol. 1 (Le Caire, 1925).

Gilles, G. (2009), Nectanebo-Le-Faucon' Et La Dynastie Lagide, *Ancient Society* 39 (2009), <http://www.jstor.org/stable/44079918>

Gomaà,F.(1977),Hebenu, in Lexikon der Ägyptologie 2, ed. Wolfgang Helck and Wolfhart Westendorf, 1075-1076 (1977).

Harrell, J. & Storemyr, P. (2009), Ancient Egyptian quarries—An illustrated overview, in Quarry Scapes: Ancient stone quarry landscapes in the Eastern Mediterranean, ed. A. Nizar, B. Elizabeth, D. Patrick, and H. Tom, Geological Survey of Norway, Special Publication 12 (Norway, 2009): 12-48.

Harrell, J. (2013), Ornamental Stones, in UCLA Encyclopedia of Egyptology 1(1), ed. Willeke Wendrich (Los Angeles, 2013).

Hartwell&Suzette(2008), Keeping up Appearances: Beauty, Ageing and Realism and Its Symbolism in Art and Literature in Ancient Egypt. Manchester: The University of Manchester, 2008, <http://hdl.handle.net/1959.14/90629>.

Helck. W & Otto, E. (1980), Tell Edfu, in Lexikon der Ägyptologie 5, ed. Wolfgang Helck and Wolfhart Westendorf, (1980).

Hogarth, D. (1896), Nectanebo, Pharaoh and Magician, *The English Historical Review* 11, no. 41 (1896), <http://www.jstor.org/stable/547514>

Hohneck,H.(2020), Naoi - Königliche Steindenkmäler in den Tempeln Ägyptens: Vom Alten Reich bis zum Ende der pharaonischen Ära, unpublished dissertation, Johannes Gutenberg-Universität Mainz, 2020, <http://doi.org/10.25358/openscience-5369>

Ian, S. & Paul,N.(1995), the Dictionary of Ancient Egypt, the British Museum (Cairo, 1995).

Jenni,H. (1998), Elephantine XVII: Die Dekoration des Chnumtempels durch Nektanebos II, in Die Dekoration des Tempelhaustores unter Alexander IV. und der Südwand unter Augustus, Mit einem Beitrag von S. Bickel, *AVDAIK 90* (Mainz, 1998): 87-101.

Kader,Zeinab Feisal Abdel.(2012), Reflections of Number Symbolism on Egyptian Sacred Architecture, ERJ. Engineering Research Journal 35, no. 3 (July 1, 2012): 265–73. <https://doi.org/10.21608/erjm.2012.67177>.

Kara,C. (2007),The Cost of Death: The Social and Economic Value of Ancient Egyptian Funerary Art in the Ramesside Period, Egyptologische Uitgaven 22 (2007).

Kitchen,K. (1991),The Chronology of Ancient Egypt,World Archaeology 23, no. 2 (1991): 206. <http://www.jstor.org/stable/124743>.

Klotz,D.(2011), A Naos of Nectanebo I From the White Monastery Church (Sohag). Göttinger Miszellen 229 (2011).

Leben,C. (1990),Bemerkungen zum Horustempel des Neuen Reiches in Edfu. Bulletin de la Société d'Égyptologie 14 (1990).

Legrain. G, (1917), Le logement et transport des barques sacrées et des statues des dieux dans quelques temples égyptiens. Bulletin de l'Institut Français d'Archéologie Orientale, 13 (1917).

Legrain,G. (1905), Notes D'Inspection,” Annales du Service des Antiquités de l'Égypte 6 (1905).

Leo,D.(2006), Saite and Persian Egypt, 664 B.C.E. (Dyns. 26-31, Psammetichus I to Alexander's Conquest of Egypt, in Ancient Egyptian Chronology: Handbook of Oriental Studies, Section 1, The Near and Middle East 83, ed. Hornung, Erik, Rolf Krauss, and David A. Warburton (Leiden/Boston: 2006).

Mariette,A.(1880), Catalogue Général des Monuments d'Abydos Découverts Pendant Les Fouilles de Cette Ville (Paris, 1880).

Mark& Joshua J. (2022), Ancient Egyptian Symbols, World History Encyclopedia. Accessed November 3, 2022. <https://www.worldhistory.org/article/1011/ancient-egyptian-symbols/>.

Miriam, L. & Joseph, G. (2006), Manning, Chronology of the Late Period in Ancient Egyptian Literature, The Late Period, vol. 3 (California, 2006), <http://www.jstor.org/stable/10.1525/j.ctt1pp5vf.3>

Myśliwiec,K. (n.d.),La Naos de Pithom. Bulletin de l'Institut Français d'Archéologie Orientale 78 (1978): 171-195.

Petrie, F. (1905), A History of Egypt: From the XIXth to the XXXth Dynasties, vol. 3 (London, 1905).

Petrie, F. (1903),Abydos II. The Egypt Exploration Fund, (London ,1903).

Pierre, M. (1957), Géographie De L'égypte Ancienne, vol. Première Partie, To-Mehou, La Basse Égypte (Paris, 1957).

Pillet, M. (1923), Le Naos de Senouset I, Annales du Service des Antiquités de l'Égypte 23 (1923): 143-158.

Randy, S. (2014), The Behdetite: A Study of Horus The Behdetite From the Old Kingdom to the Conquest of Alexander, (PhD diss., University of Chicago, 2014).

Rochemonteix, M. & Chassinat, É. (1897), Le Temple d'Edfou, vol. 1 (Paris, 1897).

Roeder, G. (1914), Naos, in Catalogue général des antiquités égyptiennes du Musée du Caire, Nos 70001–70050 (Le Caire, 1914).

Rougé, E. (1880), Inscriptions et notices recueillies à Edfou (Haute Egypte) pendant la mission scientifique de M. le vicomte Emmanuel de Rougé (Paris, 1880).

Ruiz, Ana. (2001), The Spirit of Ancient Egypt. Algora Publishing, 2001.

Shaltout, M. & Belmonte, J. (2005), On the Orientation of Ancient Egyptian Temples, 1, Upper Egypt and Lower Nubia, Journal for the History of Astronomy 36 (2005), <https://doi.org/10.1177/002182860503600302>.

Shaw, Ian, & Paul T. Nicholson (2003), The Dictionary of Ancient Egypt. Rev. and Updated pbk. ed. London: Harry N. Abrams, 2003.

Spencer, N. (2010), Shrine, in UCLA Encyclopedia of Egyptology 1(1), ed. Willeke Wendrich (Los Angeles, 2010), 2-4; The pre-dynastic chapels noted by K. Barry, Ancient Egypt: Anatomy of a Civilisation, 2nd ed., (New York, 2006).

Spencer, N. (2006) A Naos of Nekhthorheb from Bubastis: Religious Iconography and Temple Building of the 30th Dynasty (London, 2006).

Sylvie, C. & Devauchelle, D. (1984), Les Mesures Reelles du Temple d'Edfou 1, Bulletin de l'Institut Français d'Archéologie Orientale 84 (1984).

Sylvie, C. (1997), Les Chapelles Osiriennes de Dendera: Transcription et Traduction, Bibliothèque d'Étude 117 (1997).

Sylvie, C. (1987), Les Statues Cultuelles de Dendara d'Après Les Inscriptions Parietales, Bulletin de l'Institut Français d'Archéologie Orientale 87.

Szpakowska, Kasia. (2015), Snake Cults and Military Life in New Kingdom Egypt, In Walls of the Prince: Egyptian Interactions with Southwest Asia in Antiquity, Essays in Honour of John S. Holladay Jr, 274. Brill, 2015.

Teeter, Emily (2010), Feathers.” UCLA Encyclopedia of Egyptology 1, no. 1 (September 25, 2010). <https://escholarship.org/uc/item/4737m1mb> .

Wilhelm,S.(1914), Die Sogenannte Demotische Chronik: des Pap. 215 der Bibliothèque nationale zu Paris nebst den auf der Rückseite des Papyrus stehenden Texten.(Toronto, 1914).

Wilson,P.(2010), Temple Architecture and Decorative System, in A Companion to Ancient Egypt 1, ed. B. Alan (Oxford, 2010).