



---

# Scheduling of Repetitive Projects Using Line of Balance for Different Scenarios of Activities' Duration Uncertainty

Mohamed A. Tantawy <sup>a</sup>, Safaa Z. Mohammed <sup>b\*</sup>, Ahmed Elhakeem <sup>c</sup>

<sup>a</sup> Civil Engineering Department, Faculty of Engineering of Mataria, Helwan University, Cairo, Egypt

<sup>b</sup> Civil Engineering Department, International Academy for Engineering and Media Science, Giza, Egypt.

<sup>c</sup> Construction and Building Engineering Department, Colleague of Engineering, Arab Academy for Science, Technology and Maritime Transport, Cairo, Egypt.

\*Corresponding author: Email address: [Safaa\\_Zeinhom@yahoo.com](mailto:Safaa_Zeinhom@yahoo.com)

Received: 24-09-2022

Accepted: 26-09-2022

Published: 05-06-2023

---

## ABSTRACT

This study deals with the effect of uncertainty of activities' duration and the number of crews on the total project duration of repetitive projects. Based on the most optimistic (a), most pessimistic (b), most likely (m), and predicted durations (t) of the Program Evaluation Review Technique (PERT) and using the Line of Balance (LOB) method. Six potential scenarios for activities' duration uncertainty were provided in an attempt to model various situations of uncertainty that a repetitive project may face. The number of crews was calculated based on the deadline of the project and the rate of work in each scenario. A case study project of ten repetitive units with six activities each was studied for all the six scenarios. In each scenario, the LOB charts were created and the delivery durations of all units and the total project duration were calculated. The results of all the scenarios were compared, showing that the most optimistic scenario has the fastest delivery duration for the total project, while the deterioration and most likely scenarios have the slowest delivery durations for the total project. Based on the six proposed scenarios, the mean ( $\mu$ ) and the standard deviation ( $\sigma$ ) were calculated. Hence, based on any reasonable statistical distribution, the probability of finishing the project at a certain time could be calculated.

**Keywords:** Repetitive projects, LOB, Uncertainty, Scheduling, Construction management

## **1 INTRODUCTION**

Construction projects are typically extremely complex. Several elements influence this feature: a large number of activities must be completed in order to complete the project, a wide range of resources, both material and human, are required to accomplish activities, and thus large capital investments must be managed. An effective scheduling phase is critical to completing the project on schedule and within budget [1]. Project scheduling in the construction sector is typically accomplished using several strategies such as the critical path method (CPM), Program Evaluation Review Technique (PERT), and line of balance (LOB), which is used for scheduling repetitive projects.

Because repetitive projects account for a substantial amount of the construction industry, proper planning and scheduling of these sorts of projects is critical. Typical examples include multiple buildings and typical floors in a high-rise building, as well as highways and pipelines. Scheduling methods developed thus far are based on the idea that a repetitive project consists of a number of identical units. A unit network is used to describe production activities and is repeated for production units. Each of the repetitive activities in the unit network is often allocated to a crew (group of workers). The crew repeatedly and continuously executes the same unit activity [2]. One of the most commonly used methods for scheduling repetitive projects is the LOB method. The primary principle is the continuity of labor crews throughout construction units. The labor crews produce in a rhythmic manner, with no waste being intentionally planned or added into the schedule. This planning process is significantly more in line with current construction philosophy [3].

## **2 SCHEDULING OF REPETITIVE PROJECTS UNDER UNCERTAINTY**

Construction projects are complicated and take place in changing conditions. Accounting for various sources of uncertainty at the scheduling stage is critical for the effective completion of construction projects. Although many scheduling techniques for repetitive and traditional projects use deterministic input for parameters such as activity duration, number of working crews, quantities, productivity rates, costs, and other input parameters, it is reasonable to assume that many of these numbers are subject to some uncertainty [4]. Failure to adequately account for uncertainty impacting a specific project may result in an unrealistic or deceptive schedule. One of the most commonly used methods to address uncertainty is the Program Evaluation and Review Technique (PERT). PERT employs simple statistical techniques to provide a probability distribution for the project milestone completion dates [5]. Estimated activity duration in three points: most optimistic time, most likely time, and most pessimistic time. Most optimistic time (a): This time presupposes that everything will run as smoothly as possible. Most pessimistic time (b): This time expects that nothing will go as

planned and that the greatest possible obstacles will arise. Most likely or typical time (m): This is the most likely time for something to happen. The estimated completion time of an activity is determined by combining three estimations into an expected duration and a standard deviation [6].

### **3 LITERATURE REVIEW**

In 1988, Golenko-Ginzburg (1988) provided an improvement in the expected activity time based on the 'pessimistic, most likely,' and 'optimistic' completion times. Ricardo, et al. (1998) showed new practical applications of the Line of balance approach, presenting easy and clear tools for early planning, short-term scheduling, and production control on multi-story building construction sites. Lu & AbouRizk (2000) developed a PERT simulation model that integrates the discrete event modeling methodology with a simplified crucial activity identification mechanism. Pontrandolfo (2000) developed equations that relate the duration of the project to those of each conceivable PERT-path. Based on these equations, a method for calculating the exact project duration was created. Arditi et al. (2002) defined the fundamental principles that can be used to create a computerized LOB scheduling system that overcomes the problems associated with existing systems and creates solutions to problems encountered in the implementation of repetitive-unit construction. Davis (2008) discussed the methods for calculating the right general formulae for the PERT-beta distribution and how they are utilized to do stochastic project duration simulations using Excel's built-in features. Shankar and Sireesha (2009) advocated using the mean and variance of a PERT activity duration. In comparison to the numerical scenario, the mean and variance of PERT activity duration in this suggested technique and original PERT were almost identical. Agrama (2012) created a spreadsheet method that provides a schedule of times for each activity, which can be tabulated and visually shown in a LOB plot. The model's creation and computerized implementation were explained in detail. Lutz & Halpin (2013) examined using simulation and the line of balance concept to assess linear construction procedures. Hazır and Dolgui (2013) provided two robust optimization models for dealing with LOB under uncertainty. For operation times, interval uncertainty was anticipated. Hegazy, et al. (2020) introduced a framework with new visualizations and improved schedule calculations. The framework blends the LOB and Flowline visualizations to improve schedule legibility.

### **4 METHODOLOGY**

Based on the most optimistic (a), most pessimistic (b), most likely (m), and predicted durations (t) of the PERT technique and using the LOB method. Six potential scenarios for activity duration uncertainty were provided in an attempt to model various situations of uncertainty that a repetitive project may face. The six scenarios will be explained as follows:

1) Most optimistic scenario

In this scenario, it is assumed that everything will go according to plan and the activities will take the minimum time to be finished, which is PERT's most optimistic duration.

2) Most likely scenario

In this scenario, it is assumed that the project will face moderate obstacles and the activities will take the expected time to be finished, which is PERT's most likely duration.

3) Most pessimistic scenario

In this scenario, it is assumed that the project will face maximum number of obstacles and the activities will take the maximum time to be finished, which is PERT's most pessimistic duration.

4) PERT's expected scenario

In this scenario, it is assumed that the project will face the expected obstacles and the activities will take the expected time to be finished, which is PERT's expected duration.

5) Deterioration scenario

In this scenario, it is assumed that the project will start perfectly, with no obstacles, and gradually face obstacles, ending up facing maximum obstacles. The project will be divided into 3 thirds. The first third, activities, will take Pert's most optimistic duration to be finished. The second third, activities, will take PERT's most likely duration to be finished. The last third, activities, will take PERT's most pessimistic duration to be finished.

6) Improvement scenario

In this scenario, it is assumed that the project will start with the maximum number of obstacles and gradually overcome obstacles until it ends with no obstacles. The project will be divided into 3 thirds. The first third, activities, will take PERT's most pessimistic duration to finish. The second third, activities, will take PERT's most likely duration to be finished. The last third, activities, will take PERT's most optimistic duration to be finished.

In each scenario, the number of crews needed for each activity is determined in order to reach the project's deadline and will be fixed for the same activity in all units. The required number of crews for each activity is calculated as follows:

$$\# Cr = t \left( \frac{(N-1)}{(DL-CPM)} \right) \tag{1}$$

Where: #Cr is the required number of crews,  $t_e$  is the activity expected duration based on PERT, which equals:

$$t_e = \frac{(a+4m+b)}{6} \tag{2}$$

N is the number of repetitive units, DL is the deadline of the project, and CPM is the total project duration for the first unit based on the CPM technique. In addition, the production rate (R) that represents the slope of the LOB chart equals:

$$R = \frac{\#Cr}{D} \quad (3)$$

Where: R is the production rate of the considered activity, # Cr is the number of crew for the considered activity, and D is the duration of the considered activity.

The mean ( $\mu$ ) and the standard deviation ( $\sigma$ ) of all scenarios will be calculated accordingly. By knowing the mean and the standard deviation of the repetitive project, the probability of finishing the project can be further calculated.

## 5 Case Study Project

The proposed methodology was applied on a case study project that consists of 10 repetitive units with six activities each. The activities network of one unit is shown in Fig.1 and the activities' PERT durations are shown in Table 1. All the relationships between activities were assumed finish to start without lag. The deadline of the project is 180 days.

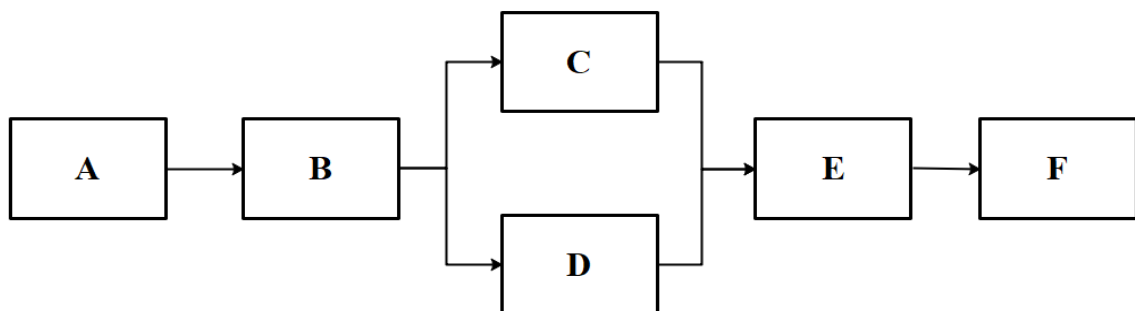

Fig.1. The project activities' network for one unit

Table 1. PERT's durations of each activity

Activity	a	m	b	t <sub>e</sub>
A	8	11	13	11
B	18	20	23	21
C	9	12	14	12
D	18	21	25	22
E	14	16	19	17
F	16	18	20	18

## 5.1 Results and Discussion

### 5.1.1 Most Optimistic Scenario

In this scenario, the LOB method was applied based on PERT's most optimistic duration and the results are shown in Fig.2. The required number of crews for each activity based on equation 1 in order to finish before the deadline of the project is 1,2,1,2,2, and 2 for activities A, B, C, D, E, and F, respectively. The total project duration in this scenario is 164 days.

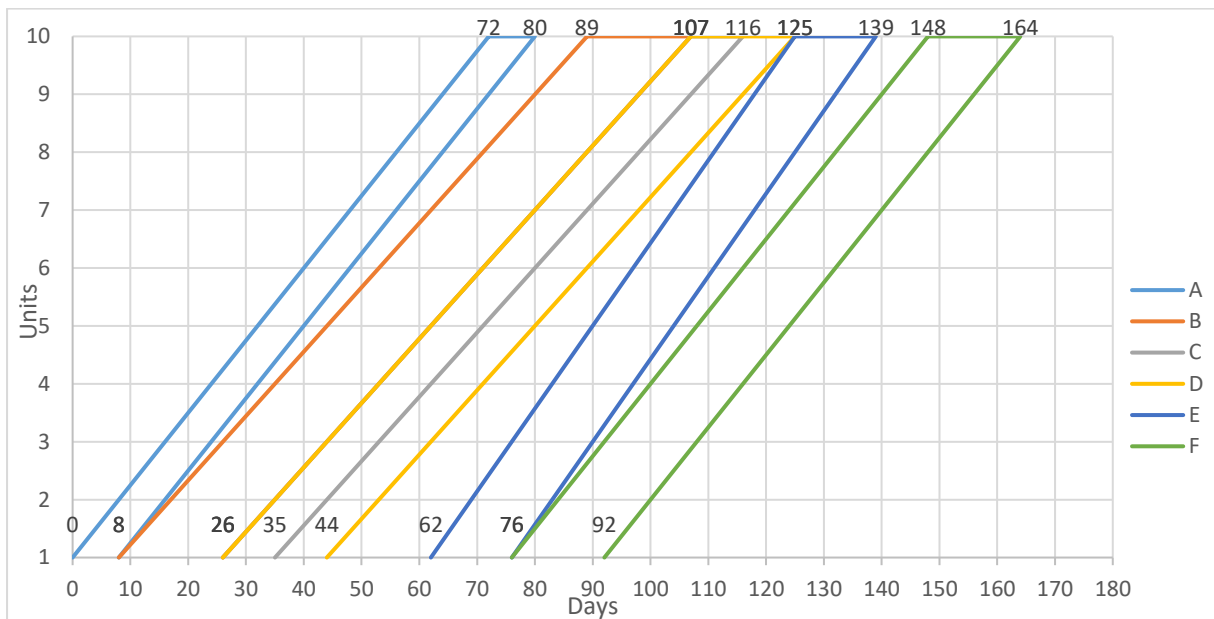

Fig. 2: LOB chart for the most optimistic scenario

### 5.1.2 Most Likely Scenario

In this scenario, the LOB method was applied based on PERT's most likely duration and the results are shown in Fig.3. The required number of crews for each activity based on equation 1 in order to finish before the deadline of the project is 2,2,2,3,2, and 2 for activities A, B, C, D, E, and F, respectively. The total project duration in this scenario is 194 days.

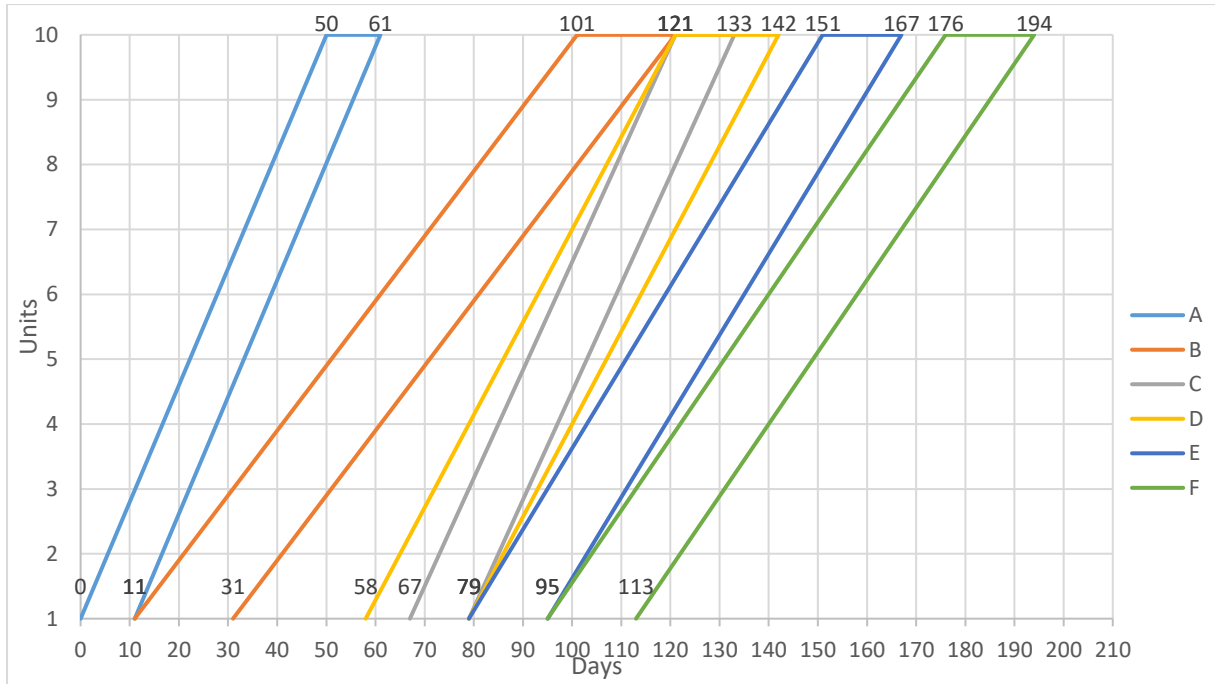

Fig. 3: LOB chart for the most likely scenario

### 5.1.3 Most Pessimistic Scenario

In this scenario, the LOB method was applied based on PERT's most pessimistic duration and the results are shown in Fig.4. The required number of crews for each activity based on equation 1 in order to finish before the deadline of the project is 2,3,2,3,3, and 3 for activities A, B, C, D, E, and F, respectively. The total project duration in this scenario is 178 days.

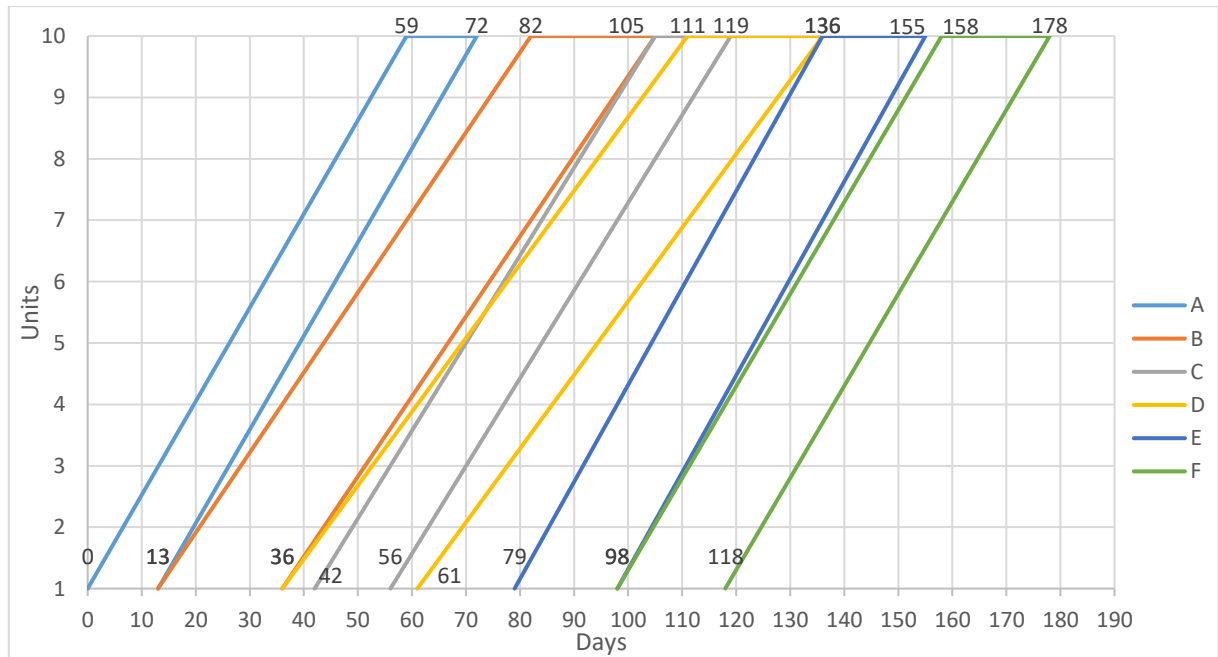

Fig. 4: LOB chart for the most pessimistic scenario

### 5.1.4 PERT Expected Scenario

In this scenario, the LOB method was applied based on PERT’s expected duration and the results are shown in Fig.5. The required number of crews for each activity based on equation 1 in order to finish before the deadline of the project is 2,3,2,3,2, and 2 for activities A, B, C, D, E, and F, respectively. The total project duration in this scenario is 170 days.

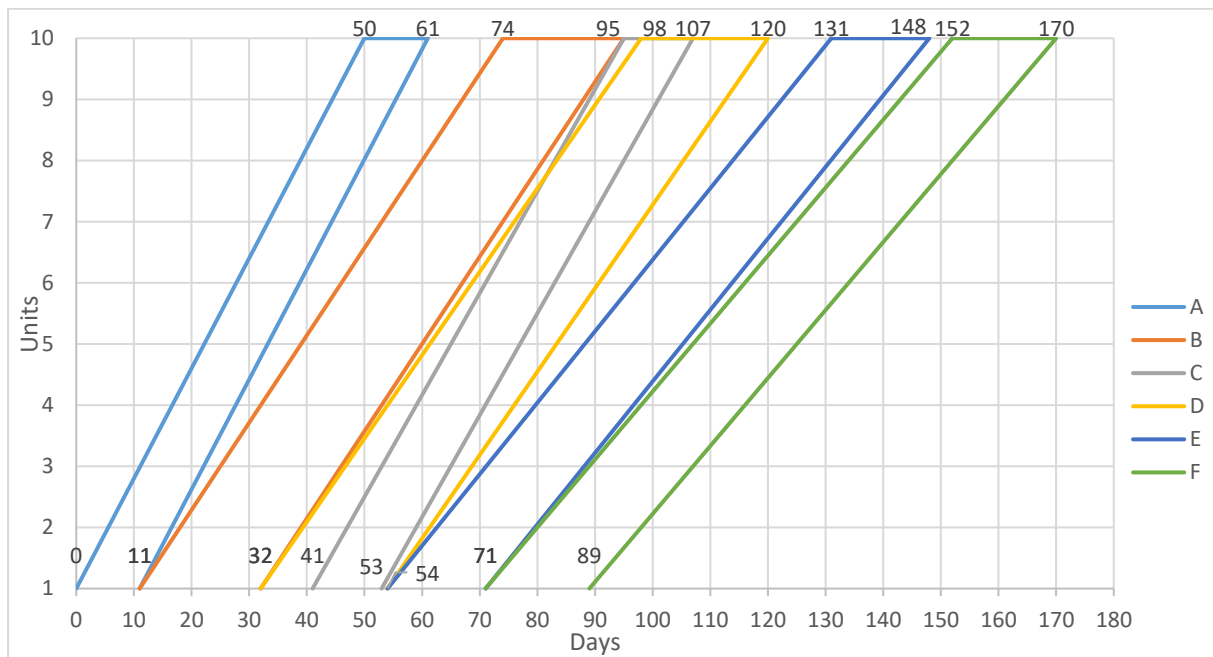
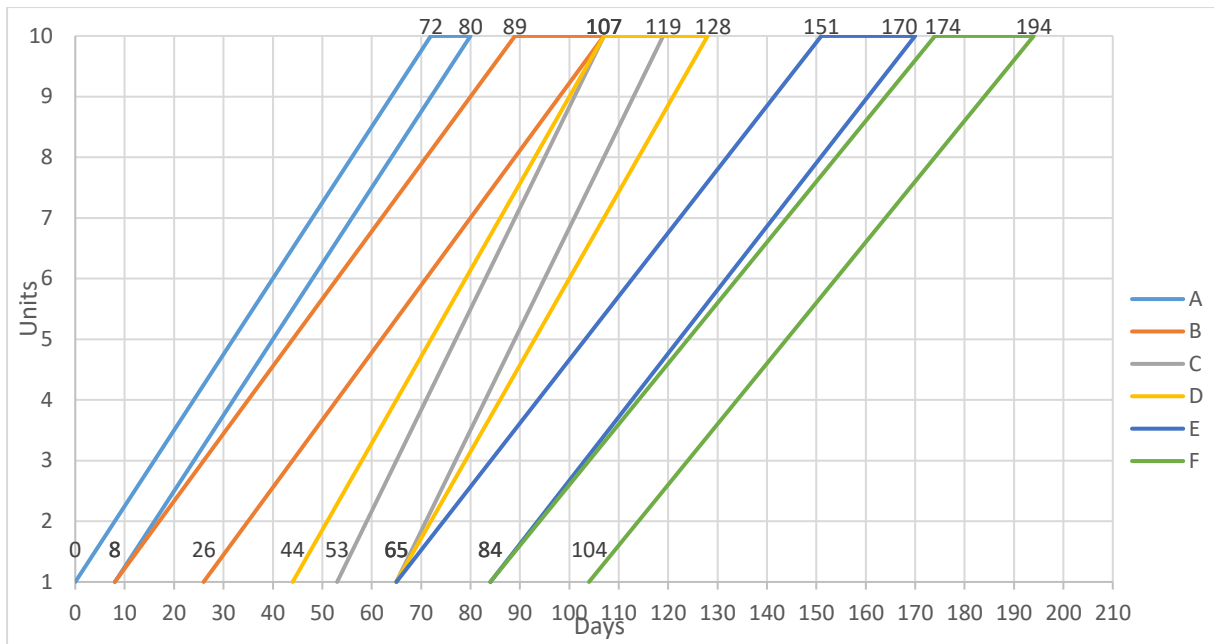

Fig. 5: LOB chart for PERT expected scenario

### 5.1.5 Deterioration Scenario

In this scenario, the LOB method was applied based on PERT’s most optimistic duration for activities A and B, PERT’s most likely duration for activities C and D, and PERT’s most pessimistic duration for activities E and F. The results of this scenario are shown in Fig.6. The required number of crews for each activity based on equation 1 in order to finish before the deadline of the project is 1,2,2,3,2, and 2 for activities A, B, C, D, E, and F, respectively. The total project duration in this scenario is 194 days.

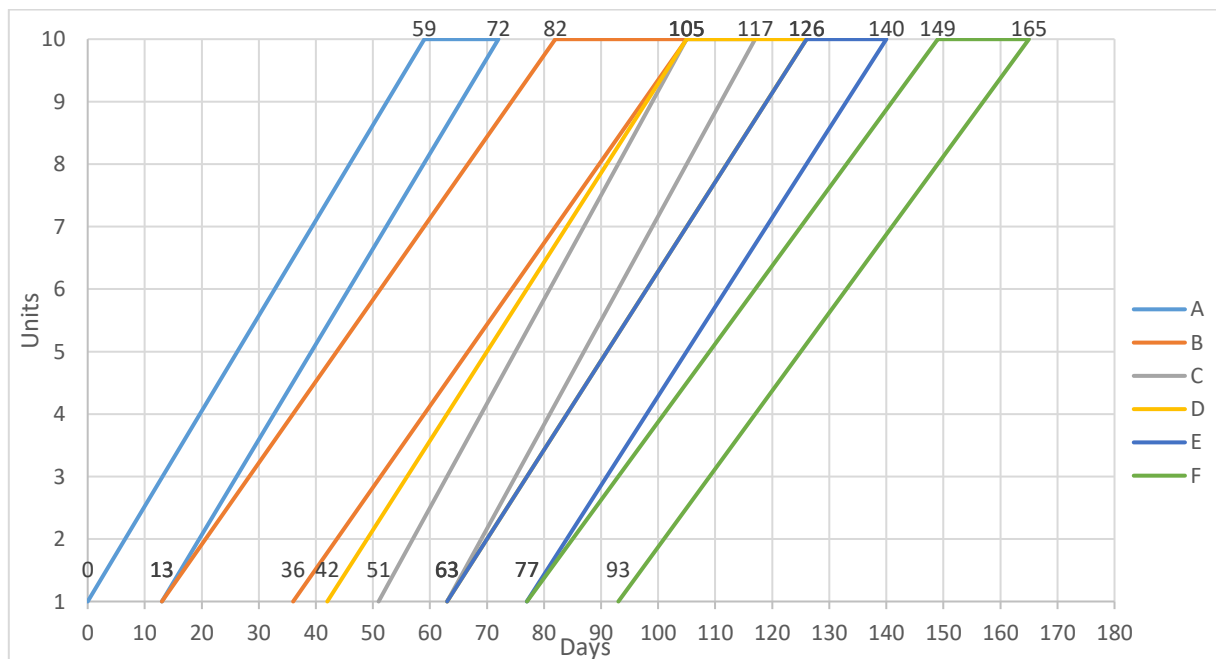



**Fig. 6: LOB chart for deterioration scenario**

### 5.1.6 Improvement Scenario

In this scenario, the LOB method was applied based on PERT's most pessimistic duration for activities A and B, PERT's most likely duration for activities C and D, and PERT's most optimistic duration for activities E and F. The results of this scenario are shown in Fig.7. The required number of crews for each activity based on equation 1 in order to finish before the deadline of the project is 2,3,2,3,2, and 2 for activities A, B, C, D, E, and F, respectively. The total project duration in this scenario is 165 days.



**Fig. 7: LOB chart for improvement scenario**

### 5.1.7 Comparison between Different Scenarios

The results of the delivery durations of all units and the total project durations for different scenarios were compared. For instance, the delivery duration for unit 1 for the different scenarios is shown in Fig.8. It is noticed that the most optimistic scenario has the fastest delivery duration with a value of 92 days due to the assumption that the time schedule will be followed perfectly without any delaying obstacles. It is also noticed that the most pessimistic scenario has the slowest delivery duration with a value of 118 days despite increasing the number of crews to overcome the delaying obstacles. The delivery duration for unit 4 for the different scenarios is shown in Fig.9. It is noticed that the most optimistic scenario and the PERT expected scenario have the fastest delivery duration with a value of 116, while the most likely scenario has the slowest delivery duration with a value of 140 days. In unit 7 shown in Fig.10, the most optimistic scenario still has the fastest delivery duration with a value of 140 days. It's also noticed that a remarkable improvement occurred on the improvement scenario and the PERT expected scenario because of the increase in the number of the working crews to finish before the deadline of the project. The deterioration scenario and the most likely scenario have the slowest delivery duration with values of 164 and 167 respectively. The delivery duration for the total project duration for all scenarios is shown in Fig.11. The most optimistic scenario has the fastest delivery duration for the total project duration as expected due to the assumption that no delay obstacles affected the project. The improvement scenario has the second fastest delivery duration of the project. That because beginning the project with the maximum possible obstacles lead to increasing the numbers of crews for each activity. These crews continued to work until finishing the projects although overcoming the obstacles gradually as assumed in this scenario. The most likely scenario and the deterioration scenario have the slowest delivery duration 14 days behind the deadline for the total project with a value of 194 days. That's because the project begun with none to minimum number of delaying obstacles leading to hiring fewer crews and continuing using the same crews despite the gradual increase of the delaying obstacles.

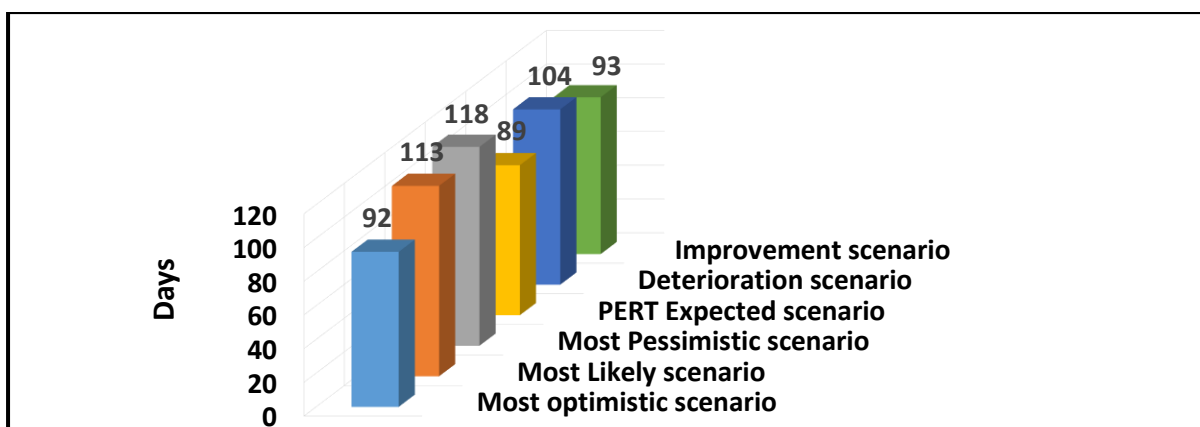

Fig. 8: Delivery duration of unit 1 for different scenarios

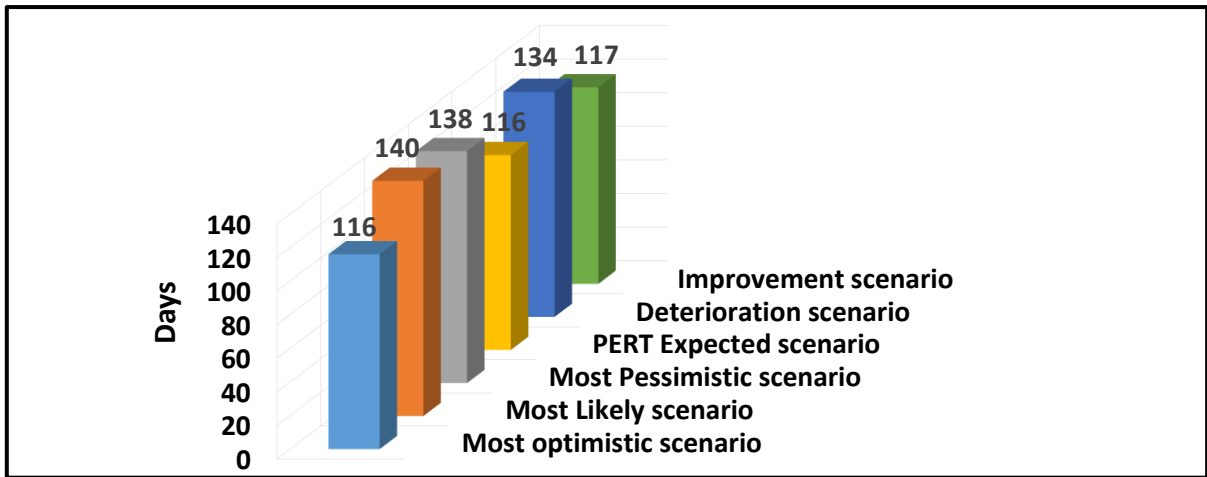

Fig. 9: Delivery duration of unit 4 for different scenarios

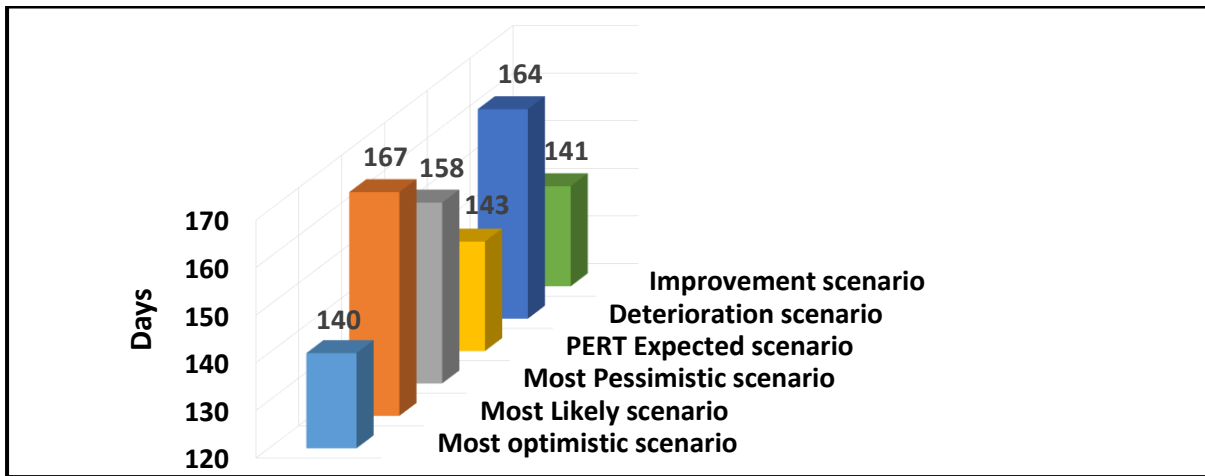

Fig. 10: Delivery duration of unit 7 for different scenarios

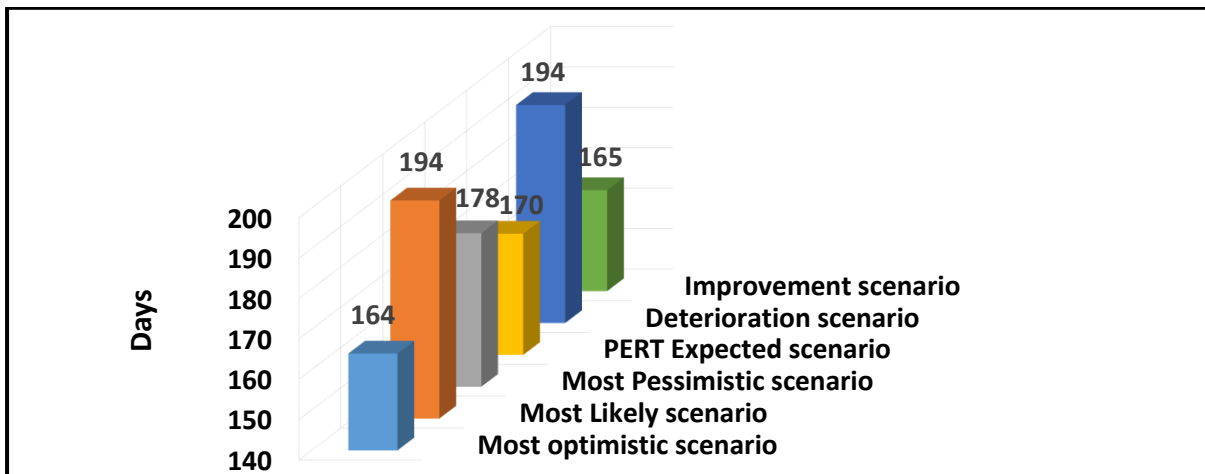

Fig. 11: Delivery duration of the total project duration for different scenarios

### 5.1.8 Calculation of $\mu$ and $\sigma$ for the total project duration

In order to, calculate the probability of finishing the project at a certain time based on any statistical distribution such as normal distribution  $\mu$  and  $\sigma$  must be calculated. In this study, based on the six potential scenarios discussed earlier. The planning engineer could calculate  $\mu$  and  $\sigma$ , hence calculating the probability of finishing the project in a certain time. For the case study project discussed in this study the  $\mu$  equals 177.5 days with  $\sigma$  equals 12.51 days.

## 6 Summary and Conclusions

In this study, the effect of uncertainty of activities' duration and the number of crews on the total project duration of repetitive projects was investigated. Six potential scenarios for activities' duration uncertainty were provided in an attempt to model various situations of uncertainty that a repetitive project may face. The number of crews was calculated based on the deadline of the project and the rate of work in each scenario. A case study project of ten repetitive units with six activities each was studied for all the six scenarios. It's concluded that the most optimistic scenario has the fastest delivery duration of the total project due to the perfect circumstances. Also, the scenarios that start with a lot of delaying obstacles such as; the improvement scenario, the most pessimistic scenario and the PERT expected scenarios could finish the project before the deadline by increasing the number of working crews. Scenarios that start the projects with minimum delay obstacles and increase obstacles with time with the same assigned work crews may finish the project behind the deadline. Based on the six potential scenarios in this study  $\mu$  and  $\sigma$  could be calculated. Hence, based on a reasonable statistical distribution the probability of finishing repetitive projects at a certain time could be calculated.

## REFERENCES

- [1] M. E. Bruni, P. Beraldi, F. Guerriero et E. Pinto, «A scheduling methodology for dealing with uncertainty in construction projects,» *Engineering Computations: International Journal for Computer-Aided Engineering and Software*, vol. 28, n° 18, pp. 1064-1078, 2011.
- [2] M. ZEESHAN et S. KHATOON, «A REPITITIVE PROJECT SCHEDULING BY INTEGRETING CRITICAL PATH METHOD AND LINE OF BALANCE METHOD,» *International Journal of Advanced Scientific and Technical Research*, vol. 5, n° 16, 2016.
- [3] M. Ricardo, L. Fernando, M. Heineck et O. L. Vaca, «NEW APPLICATIONS OF LINE OF BALANCE ON SCHEDULING OF MULTI-STOREY BUILDINGS,» Hughes, 1998.
- [4] B. Ibrahim, *Optimized Scheduling of Repetitive Construction Projects under Uncertainty*, Montreal: PhD Dissertation, Concordia University, 2014.

- [5] R. F. Aziz, «RPERT: Repetitive-Projects Evaluation and Review Technique,» *Alexandria Engineering Journal*, pp. 81-93, 2013.
- [6] R. NAFKHA, «THE PERT METHOD IN ESTIMATING PROJECT DURATION,» *Information Systems in Management*, vol. 5, n° 14, p. 542–550, 2016.
- [7] N. R. Shankar et V. Sireesha, «An Approximation for the Activity Duration Distribution, Supporting Original PERT,» *Applied Mathematical Sciences*, vol. 3, pp. 2823 - 2834, 2009.
- [8] P. Pontrandolfo, «Project duration in stochastic networks by the PERT-path technique,» *International Journal of Project Management*, vol. 18, p. 215±222, 2000.
- [9] J. D. LUTZ et D. w. HALPIN, «Analyzing Linear Construction Operations Using Simulation and Line of Balance,» *TRANSPORTATION RESEARCH RECORD*, 2013.
- [10] M. Lu et S. M. AbouRizk, «SIMPLIFIED CPM/PERT SIMULATION MODEL,» *JOURNAL OF CONSTRUCTION ENGINEERING AND MANAGEMENT*, vol. 126, 2000.
- [11] T. Hegazy, D. A. Saad et K. Mostafa, «Enhanced Repetitive-Scheduling Computation and Visualization,» *Journal of Construction Engineering*, vol. 146, n° 110, 2020.
- [12] Ö. Hazır et A. Dolgui, «Assembly line balancing under uncertainty: Robust optimization models and exact solution method,» *Computers & Industrial Engineering*, vol. 65, p. 261–267, 2013.
- [13] D. GOLENKO-GINZBURG, «On the Distribution of Activity Time in PERT,» *Operational Research Society Ltd*, vol. 39, pp. 767-771, 1988.
- [14] R. Davis, «Teaching Project Simulation in Excel Using PERT-Beta Distributions,» *Institute for Operations Research and the Management Sciences*, vol. 8, pp. 139-148, 2008.
- [15] D. Arditi, O. B. Tokdemir et K. Suh, «Challenges in Line-of-Balance Scheduling,» *JOURNAL OF CONSTRUCTION ENGINEERING AND MANAGEMENT*, pp. 545-556, 2002.
- [16] F. A. E.-M. Agrama, «Linear projects scheduling using spreadsheets features,» *Alexandria Engineering Journal*, vol. 50, pp. 179-185, 2012.