

Airbag systems and their components

Mokhtar Ashraf Mokhtar, Ahmed Ashraf Mokhtar, Khaled Yasser Al-Sayed

Military Technical College, Cairo, Egypt, mokhtarashrafmokhtar60@gmail.com, ahmedashrafmokhtar2006@gmail.com,
khaledyasseralsayed60@gmail.com

Supervisor: Hisham Mohamed Eltaher, Professor

Military Technical College, Cairo, Egypt, hisham.kamel@mtc.edu.eg

Abstract- This paper presents an overview about the airbag systems and some of the engineering concepts behind them.

Because of the exponentially increasing development of the automotive industry over the last decades, automotive pioneers were racing to secure their place in the automotive market. In their attempts, they were faced with the task of making their products safer to the public. In one way or another this was the main motive behind the design of air bag systems. It has been statistically proven that safety belts and air bags systems reduce the danger of injury by 80% to 90% when compared with unprotected drivers and according to the (insurance institute for high way safety) using seat belts and air bags decreases fatalities by 37% and sever injuries by 52%.

Sense their introduction airbags have played a critical role in saving millions of lives and with continuous improvements, there is a potential to save even more lives.

Keywords: automotive airbag; vehicle electronic systems; mechatronics systems

I. INTRODUCTION

In 1973, GM's "Oldsmobile" tornado was the first vehicle to have an airbag system and it was initially called (cushion restraint system). In the year 1981 following the "safety act", the public moved their attention towards airbag systems and they became a major factor effecting a customer's choices. In 1986, the NHTSA (National High Way Traffic Society Administration) required all vehicles manufacturers to use seat belts in their vehicles. The (1991-1992)102nd congress witnessed the publication of a law that requires all the passenger cars and light trucks, which built after 1998 to have air bag systems for the driver and front seat passenger.

Although airbag systems are, a major part in the safety of an occupant it is also a necessity to back it up with a seat belt the use of seat belt paired with the airbag system is necessary to ensure that the occupant is at the correct position in (the airbag deployment) during impact.

The following sections will present a brief description about airbags construction, operation, control system and common causes of malfunction.

II. COMPONENTS OF AIRBAG SYSTEMS

A. Airbag module

B. Air bag steering wheel and air bag cover

One of the most important properties of the steering column is that it should move as little as possible during an accident to

establish a relatively constant distance between the steering wheel and the driver during impact, on which the designer can base his calculations. It must also have enough installation space for the system components. The air bag cover is made in a way such that it breaks at a specific point to allow for the inflation of the airbag.

C. Inflator and inflator support

In earlier systems, the initial idea was to carry the inflation gas in a container, which might be subjected to leakages. Modern inflator uses a metallic case, which contains a metallic tissue filter surrounding the combustion chamber. The reacting materials inside the combustion chamber are 60% sodium Azide (NaN_3), 20% silicon oxide (SiO_2) and a 20% potassium nitrate (KNO_3). The reaction starts when the triggering wire is melted due to high current and the exothermic reaction between sodium Azide with potassium nitrate starts the reaction products is then filtered by the metallic tissue filter in order to stop solid particles, which might be harmful and cool the gas down thus inflating the airbag.

D. The airbag material

The first generation of airbags were coated by polychloroprene from the inside modern developments have led to the introduction of an airbag that in addition to having a gastight fabric it also has a gas releasing fabric part a (thinner) which led to less weight and volume for the folded airbag. the main material used in airbags nowadays is nylon 6.6 because of its high thermal resistance, sufficient elongation, and excessive strength, furthermore Small ports were added to the design of the airbag to allow escaping of gas which permit a controlled deflation. The airbag also has sewn in restrains to restrict the expansion of the airbag in the occupant direction.

E. The contact unit

The contact unit transmits the triggering signal, monitors the signals to from the airbag module, and allow for an electric interface between the control system and the module at different steering wheel angle

III. THE SENSOR SYSTEM

A good acceleration sensor does not just calculate the acceleration of the vehicle at a specific time, it should also provide data that enables an accurate prediction of the deceleration curve in the event of a collision, and this requires the sensor to record infinitely small and rapid changes in

acceleration. Until recent time (before the new developments in piezoelectricity and semiconductors), such sensors were not possible.

These sensors could either be mechanical or digital (signal producing) sensors.

A. Mechanical sensors

They were the only method available to detect deceleration of vehicles at their time because of the lack of a better method and to some extent they manage to operate as intended and perform their function to some extent.

Examples of such sensors are:

Electromechanical ball and tube

The metallic ball is held in place by a permanent magnet. During an accident, the effect of sudden collision throws the ball out of position and allows it to close the circuit as shown in figure (1); this sensor can only react to the deceleration in one direction. This makes it unreliable and it must be paired with other sensors to cover all possible impact directions.

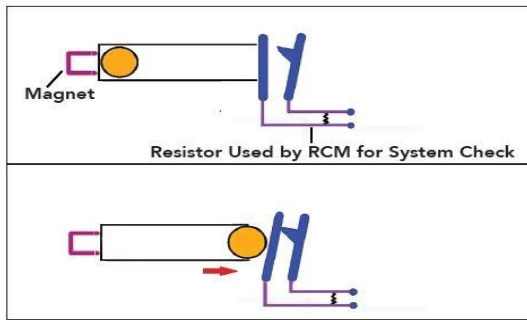
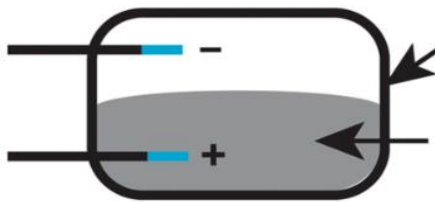

Fig. 1 electromechanical ball and tube sensors

Mercury sensor

A mercury drop is placed inside of an inclined tube in the case of sudden impact the drop moves towards the electrodes due to inertia force which closes the contact as shown in figure (3) triggering the system and releasing the airbag.



Fig(1) b: during deceleration

B. Cylinder sensor

Spiral spring is wound around a cylindrical mass. when the vehicle decelerates the spring unwinds until it reaches a specific deflection value which allows it to close the contact as shown in figure (2) it's similar to the ball and tube in that it has the same downsides as the Electromechanical ball and tube sensor.

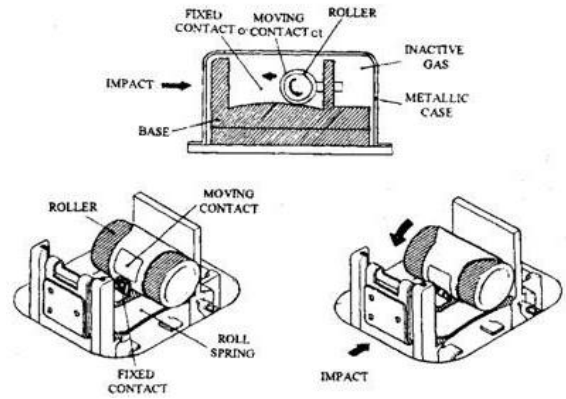

Fig. 2 Cylinder senso

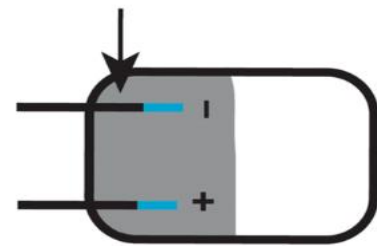

Fig. 3 a: initial state

Signal producing sensors

When companies began mass-producing vehicles that contained airbags systems they mainly relayed only on a single mechanical/electromechanical sensor, which led to faulty triggering because of sensor malfunction, in order to increase safety engineers had to depend on double track systems which was very complex and impractical, this lead to the introduction of digital sensors (signal producing sensors).

The ECU in this kind of systems takes other inputs from wheel speed sensor, gyroscopes, brake pressure sensor and seat occupancy sensors; the information acquired by sensors is processed by evaluation electronics and sent to the control module, these processes are used in order to differentiate between serious accidents and a simple pump\ pit.

Examples of such sensors are:

Piezoelectric sensor

It consists of a piezoelectric crystal and a movable mass attached to it see figure (5), when force due to sudden mass deceleration is applied on the crystal the change in the molecular structure of the crystal produces a voltage difference that can be detected by the control module as shown in figure(6).

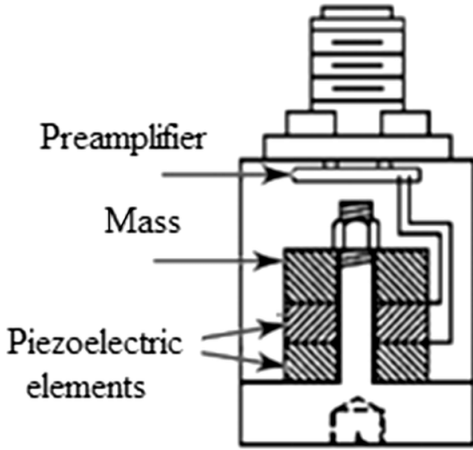

Fig.5 piezoelectric sensor components

Neutral position after deformation

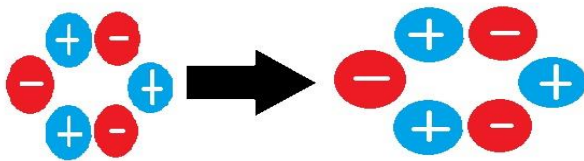

Figure (6) piezoelectric crystal subjected to stress

Capacitive sensor

It consists of a set of parallel plates moving/fixed, in case of sudden deceleration the capacitance changes because of the change in the spacing between the plates this change in capacitance can be transformed into a signal, which the control module can use to determine the state of the system as shown in figure (7).

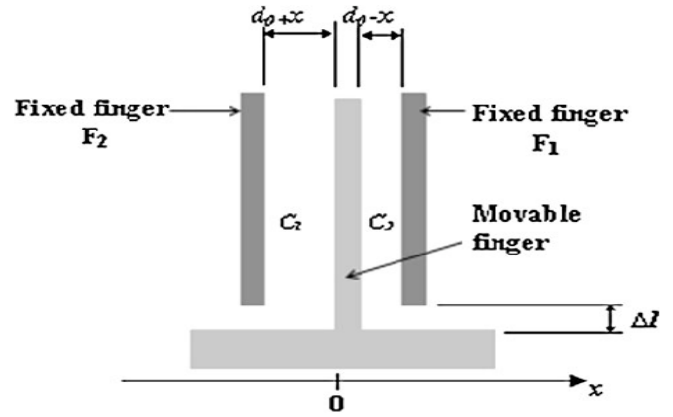

Fig .7 operation of capacitive sensor

2.3 Control and diagnostic unit

2.3.1 The control unit

The ECU (electronic control unit) is the linking component between the sensors system interface and the airbag module. Its main function is to make the decision of whether the airbag needs to be triggered depending on the acceleration curve. It has a sufficient energy to trigger the system in case of sudden power failure because of a condenser, which allows for triggering for up to (200-300ms) after is power is disconnected.

Some vehicles may use an external airbag control unit, which is separated from the main vehicle ECU this is mainly used as a method to shortening the distance the signal needs to travel to and from the control unit, which leads to a more responsive system.

The diagnostic unit

The diagnostic unit performs two separate tests one as soon as the vehicle ECU is turned on (primary test) and another one continuously during operation (secondary test).

Primary test

It makes sure the system is ready for triggering by putting it into a simulated state of deceleration; if the system is operating correctly, the control lamp will go out which means that the system is working as intended.

Secondary test

During vehicle operation the system is continuously monitored by the diagnosis unit which have the ability to determine wither the error is just a small disturbance or a serious fault in the system circuit.

IV. CRASH RECORDING SYSTEM PROPERTIES

A good crash recording system must allow for an accurate prediction of the severity of the impact at an early stage and then decides whether the airbag needs to be triggered or not, this process must be done within a very short time window to ensure the safe inflation of the airbag.

A. Critical triggering time

The simplest way to determine the moment of triggering is by using the “13cm @ 30ms” rule, which states that in order to calculate the exact moment of triggering we subtract 30ms from the time needed for the passenger/driver to move 13 cm forward. This is based on the assumption that the driver is 39 cm away from the airbag and length of the airbag is 26 cm and that the airbag takes around 30ms to fully inflate.

B. 5. Airbag release threshold

As indicated previously releasing of the airbag depends mainly on the change of vehicle speed Δv , in older systems this was a fixed value was predetermined by the manufacturer after which the airbag would open.

Modern systems nowadays rely on the use of a far more complex calculations to read the behavior of the deceleration curve and determine the moment of triggering, as the severity of the accident increase the deceleration curve slope increase and the system can predict the effect of the accident. In addition to this, most new vehicles are supplied with a very advanced system called EES (energy equivalent systems) which measures the amount of the vehicle kinetic energy converted during an accident into deformation energy; in general, most EES systems trigger the airbag at speeds of 35km/h with an error window of 5km/h.

V. PROBLEMS CAUSING MALFUNCTIONING OF AIRBAG SYSTEMS

When it comes to airbags systems, the cases of a malfunction may be divided into two main reasons. Either it is the failure to release at a serious accident or releasing when it is not needed which may cause extra repair cost. This may occur because of a serious fault in the system such as poor sensor conditions a system short circuit even a problem with the ECU. On the other hand, it may also be caused by a very unremarkable stimulus like a blow to the underbody or simply a rough pump.

VI. CONCLUSION

Airbags are one of the most important safety systems in the world when you consider the number of people traveling in motor vehicles every day. The engineers whom jobs are to design those type of systems and the technology behind them are directly responsible for the lives of millions every single day.

The design of airbags needs a good understanding of both mechanical and electric systems, which is an essential requirement in today’s engineers.

References

- [1] AL-Hossein M. Sharaf, “Vehicle Electronic Systems III”, MTC Printed Notes. 2018.
- [2] How airbags went from controversial to commonplace, insurance institute for high way safety Report, volume:42
- [3] Highway safety-part B: NHTSA authorization and general provisions, bill no 1782, 102nd congress, first session, (1991-1992). Available online: <https://www.congress.gov/bill/102nd-congress/housebill/12950>
- [4] Cobham, Oldsmobile tornado 1966-1978, USA, 1985.
- [5] National High Way Traffic Society Administration data presented at <http://www.hwysafety.org>, “airbags Questions and Answerers”.
- [6] IKA, a test procedure for airbags report no:8328,2008
- [7] Golther.w, Honk.g, Swoboda.p “fabric for airbag” US5236775 A patent published in Aug 17,1993
- [8] Kartik B, “AIRBAGS FOR SAFETY SYSTEMS IN AUTOMOBILE ENGINEERING, June 2020. Available online: https://www.researchgate.net/publication/339500056_Airbags_for_safety_system_in_Automobile_engineering .
- [9] Mufaddal B, “nylon 6.6 fiber: preparation, properties and applications”, September 5,2013. Available online: https://textilelearner.net/nylon_66_fiber_applications/