

# Voltage Profile of Hosting Capacity Enhancement Based on Smart Inverter Reactive Power Control for PV Grid Connected System

Ahmed Alfouly<sup>1</sup>, I. Hamdan<sup>1</sup>, Mohamed A. Ismeil<sup>1,2, □</sup>



**Abstract:** There are various types of renewable energy sources worldwide, including Photovoltaic (PV) systems. PV systems have witnessed significant growth in recent years to meet the demands of economic, technological, and environmental advancements. However, as Distributed Energy Resources (DER) penetration increases, active distribution networks face numerous challenges, making it increasingly complex for distribution system operators to effectively manage and design their networks. One of the key challenges involves maintaining voltage profiles within specified limits to avoid load reduction or decreased renewable energy production. To address this issue, Photovoltaic (PV) inverter based on reactive power control schemes offer a potential solution. This paper focuses on the implementation of reactive power control using both Model Predictive Controller (MPC) and PI controls. The objective is to maintain the voltage profile within prescribed limits at the bus connected to the PV system in a low-voltage distribution network. The study considers two scenarios: over-voltage and under-voltage, demonstrating the enhancement of Hosting Capacity (HC) through reactive power control. MATLAB SIMULINK is employed to analyze the effects and quantify the improvements. The findings of this research highlight the significant support provided by smart inverter reactive power control in increasing the integration of PV solar systems into the grid, thereby enhancing the HC of the system.

**Keywords:** PV System; Distribution Network; Smart Inverter; reactive power control; Hosting Capacity.

## 1 Introduction

Received: 18 February 2023/ Accepted: 6 June 2023

□ Corresponding Author: Mohamed A. Ismeil  
[mohamedismeil@eng.svu.edu.eg](mailto:mohamedismeil@eng.svu.edu.eg)

Other Authors: Ahmed Alfouly, [ahmedAlfouly@eng.svu.edu.eg](mailto:ahmedAlfouly@eng.svu.edu.eg),

I. Hamdan, [IbrahimHamdan86@eng.svu.edu.eg](mailto:IbrahimHamdan86@eng.svu.edu.eg)

1. Electrical Engineering Department, Faculty of Engineering, South Valley University, Qena 83523, Egypt

2. Electrical Engineering Department, Faculty of Engineering, King Khalid University, Abha 61411, Saudi Arabia

The rise of the average temperature on the earth's surface is referred to the global warming, this increase in temperature is because the world uses fossil fuel that produces the gasses emissions such as Carbon Monoxide (CO), Carbon Dioxide (CO<sub>2</sub>), and water vapor [1-3]. One solution to decrease the temperature of the earth by reducing the using fossil fuel by using Renewable Energy Sources (RES), they are several types of (RES) such as Photovoltaic (PV) systems, wind energy, biomass, nuclear energy, and hydropower [4-5].

In recent years PV systems are becoming interesting in the world to add to the grid more than 130GW by the end of 2021 and add its largest 179 GW by the end of 2022 to become the total solar energy in the world at the end of 2022 is 1019 GW [6-7]. Nevertheless, the integration of PV systems into the grid has led to operational challenges such as voltage rise problems, thermal overloading, and voltage imbalance. Consequently, the Hosting Capacity (HC) of PV systems is determined by the limitations imposed by these operational challenges. HC can be defined in various ways, including situations where the amount of PV generation exceeds the local consumption, which results in negative impacts. The threshold within which these impacts are deemed acceptable is referred to as the Hosting Capacity (HC) [8-9].

Smart inverters can mitigate the effects of increasing PV penetration through the implementation of actual power reduction and/or reactive compensation. Depending on the voltage level, these systems can provide adjustable control by employing reactive compensation or limiting actual power and reactive power control [10-11].

There are three different approaches to assessing hosting capacity: deterministic, stochastic, and time series. These methods focus on studying the impact of high solar PV penetration on voltage levels and the loading of lines, cables, and transformers within low-voltage distribution systems. However, these approaches often overlook additional grid irregularities. The deterministic, stochastic, and time series techniques aim to evaluate and analyze the effects of increasing PV output power penetration on voltage levels and loads [12]. Smart inverters have many functions such as voltage control support and frequency control, voltage control support similar to active power control, a reactive power control, and operated a new

control combine between the active and reactive power control, this a new control to maintain the voltage bus operated nearly 1 pu but reduce the amount of PV system [13]. Because the loads demand is different from the PV generation with time, the author [14] designed PV penetration based on the monte carlo method by using reactive power control to enhance the hosting capacity of the system.

The Model Predictive Control (MPC) method utilizes a forecast generated by the proposed model to determine the control actions. In MPC, only the essential elements of the ideal feedback are incorporated into the control system. As a result, the ideal control problem is addressed again at the next sampling time, using the current system state information as a basis. MPC is particularly well-suited for systems with nonlinear dynamics and constraints on states and input variables, due to the inherent uncertainty in the information. This approach allows for improved trajectories in the control feedback, taking into account model uncertainty and the simultaneous control of multiple variables [15-16].

This paper provides the control of the maximum amount of solar energy into the grid by using reactive power control in two cases over and under voltage by using the control of current by different control PI control and MPC control and using the reactive power control to increase the amount of solar energy with connected to the utility. Additionally, the ideal operating manner and characteristics for a smart inverter are investigated to improve the feeder's capacity to accept PV levels and lessen the voltage violation problem.

In this paper, section 2 presents the solar system components connected to a grid, section 3 presents the different control to enhance the HC, section 4 shows the results of when using the reactive power control and improving the HC, and section 5 present the conclusion of the work.

## 2- PV Solar System Components

The main components of a PV production system are an inverter and PV panels. Solar panels with the required current and voltage for practical usage are made by connecting cells in parallel, series, or both configurations. When solar radiation reaches a module, the PV effect transforms the energy from the sun into electricity, causing an electrical potential fluctuation at the terminals of the module [17].

The inverter could be a simple DC-AC converter that provides a magnitude- and frequency-dependent resultant signal depending on the actual values of the system. Inverters usually use solid-state switching devices such as thyristors or semiconductor device bipolar transistors, which are turned on by the entering signal in order to generate the resultant signal [18].

Residential PV inverters are no longer limited to

performing only Maximum Power Point Tracking (MPPT) in DC-AC conversion. With the regulatory capabilities of smart inverters, additional functionalities such as real power limitations and reactive compensation have become feasible. Control strategies commonly employed in smart inverters include maximum permitted generation, constant power factor, reactive power, and active power control. These control methods enable voltage regulation by either reducing the injection of real power or utilizing reactive compensation [19].

A simple LV distribution system supplying a 10 kVA lumped load and a 100 kVA PV system in conclusion, MATLAB SIMULINK was used to create a 100-meter-long feeder, as shown in Fig. 1. Table 1 provides a summary of the specific details of the PV system, which runs at Maximum Power Point (MPP). According to the PV capacity, it has the appropriate number of PV modules connected in series and parallel. We provide the PV panel's current and voltage at MPP at an irradiance level of 1000 W/m<sup>2</sup>.

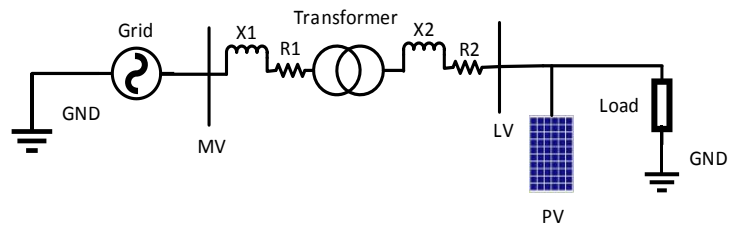

Fig.1. Single line diagram of PV system with connected a grid.

Table 1. PV solar system parameters

Parameters	Value
PV Energy Rating	100 KW
Solar Energy Panel	305 W
Current Models at MPP	5.58 A
Voltage Models at MPP	54.7 V
Radiance Restrictions	1000 W/m <sup>2</sup>
Number of Series Models	5
Number of Parallel Models	66
Temperature	25 <sup>o</sup> c
Distribution transformer	100KVA, 25/0.26 KV

## 3- Smart Inverter Technique and Hosting Capacity Determination

The definition of PVHC is the maximum connected PV system with a grid without a negative impact on the system's normal operation, the HC on the system depends on several parameters such as over-voltage and under-voltage of the system, thermal conductor on transformer and lines, and also affected by Total Harmonic Distortion (THD) of the PV inverter or the grid [20]. They are several types of obtaining the PVHC such as increasing the PV generation by using smart inverter control or using the filter to reduce the losses and harmonic of the system, any system contains the

fundamental component which benefits from the system and harmonic component that signals unwanted in the system that produces the heating losses and affects the stability of the system, to eliminate the harmonic signals by using different methods similar to using filters ( passive filter and active filter).

Another solution to enhance PVHC by using a smart inverter, smart inverter different from the traditional inverter in connected and operation, autonomy, adaptability, self-awareness, cooperativeness, connected/disconnected, controls of (active power, reactive power, combine, power factor, frequency control, and time management), and dynamic regulation of battery charging [21]. Real power control is a relationship between the active power from the PV system and the bus voltage connected to the solar system, the active power control operated when over-voltage occurs by reducing the amount of real power to maintain the voltage violation limitation if they continue the over-voltage occurs can sleep the inverter and the active power is reaching zero but actually the active power doesn't reach zero.

Reactive power control is a type of smart inverter control. It establishes a relationship between the reactive power, whether injected or absorbed, in a PV inverter and the bus voltage when connected to the PV system in a grid. The operation of reactive power control is illustrated in Figure 2. In the event of an under-voltage, the control functions in a capacitive manner, injecting reactive power until the voltage approaches the reference voltage. This control method is also utilized to increase the active power injection into the grid during under-voltage scenarios, thereby improving the HC of the system. On the other hand, when over-voltage occurs, the control operates in an inductive manner, absorbing reactive power to maintain the voltage at the bus equal to the reference value. Furthermore, it ensures that the actual power production from the PV system remains constant.

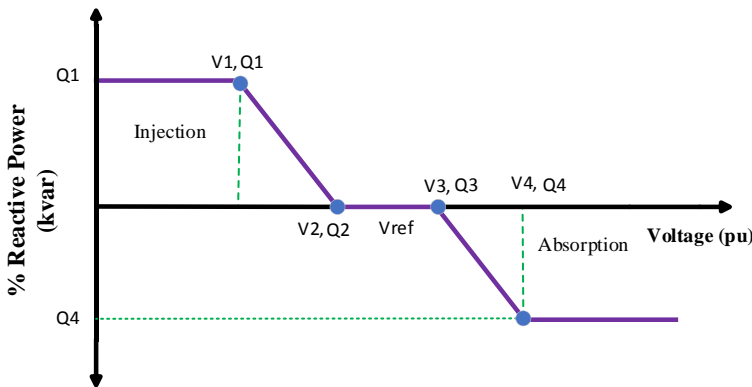

Fig.2. Reactive power control curve.

The reactive power support block computes the required reactive power absorption or injection;  $Q$  (referred to as  $I_q$ ) at a measured voltage,  $V_{ac}$ , using the formula (1).

$$Q = \begin{cases} \frac{V_{ac}}{|V_{ac}|} * (|V_{ac}| - V_{ac\_ref}) * K_q & \text{if } |V_{ac}| > V_{ref} \\ Zero & \text{Otherwise} \end{cases} \quad (1)$$

where,  $V_{ac}$  ( $V_{ac} = V_{ac\_ref} - V_{ac\_bus}$ ) is the input voltage to the reactive power controller, and  $K_q$  is the reactive current droop gain. The inverters are large while using their rated capacity, as indicated by [22] allowing them to provide 44% reactive power. The  $I_{qref}$  is limited to avoid exceeding the inverter current limit specified in [23-24].

The construction of the PV solar inverter controller, which gauges DC voltage in relation to a DC reference, is shown in Fig. 3. It generates a gain-related mistake, which the MPC Controller then corrects to yield  $I_{dref}$ . The busbar (Bus) measured voltage is compared to the reference AC voltage by the reactive power control.  $I_{qref}$  is produced after a suitable controller corrects the problem. It is also controlled by maximum and lowest settings. To assess the effectiveness of the developed reactive power controller in increasing hosting capacity, simulation results using the controller are run in MATLAB Simulink.

#### 4- Simulation Results

Based on the system shown in fig. 1 and the control system demonstrated in fig.3, the results comparing PI and MPC based on reactive power control when using a smart inverter in two cases (under-voltage & over-voltage), and show the results in reactive power control to enhance the HC of the system.

##### Case 1: under-voltage

The effect of an under-voltage state on various controllers was examined by reducing the secondary of the transformer using three winding transformers at  $t = 5$  sec and keeping it constant. Fig.4 illustrates the real power, reactive power, and voltage bus. In Fig.4(a), the active power remains constant at 100.3 kW before and after the under-voltage conditions when using MPC control. However, with the under-voltage conditions, the active power reduces to 99.82 kW. Fig.4(b) demonstrates the reactive power with PI and MPC controls. The reactive power control injects reactive power during under-voltage conditions to maintain the bus voltage near the reference voltage. The amount of reactive power reduces from 39.01 kVAR to 24.18 kVAR (38.1 percent) when using MPC control. Finally, in Fig.4(c), the bus voltage at the connection between the PV system and the grid is shown. The voltage bus increases by 2.35 percent when MPC control is used.

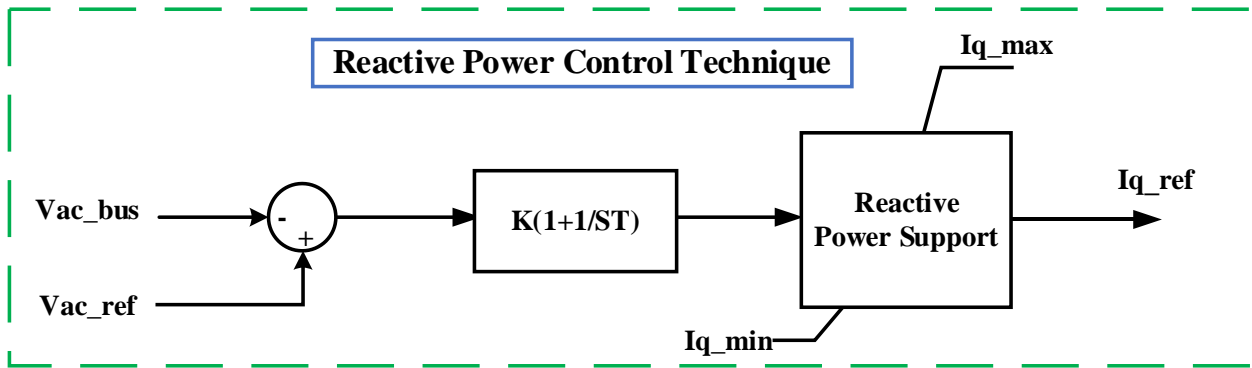
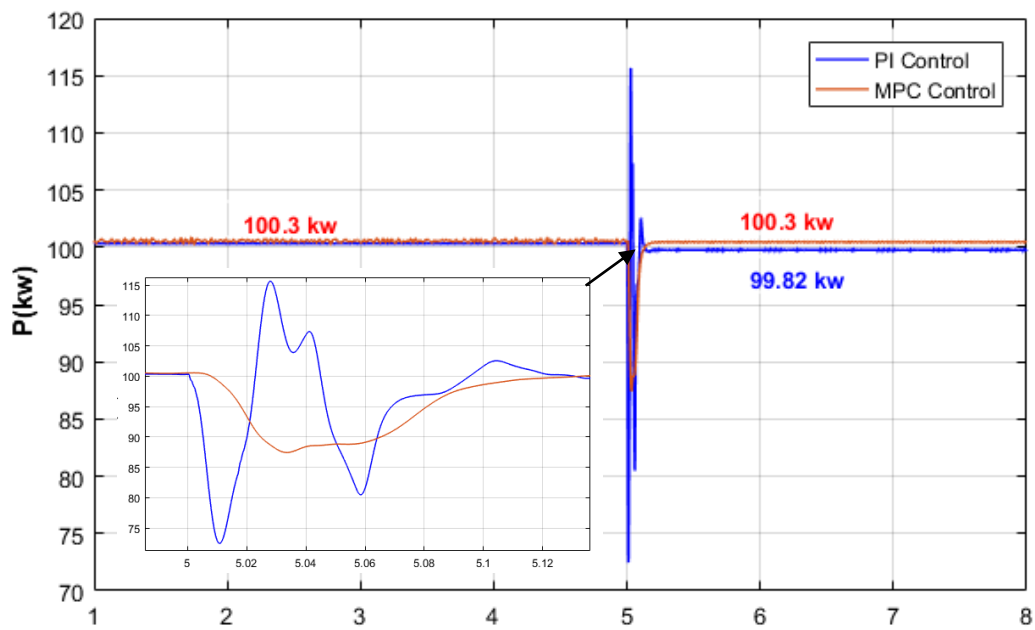
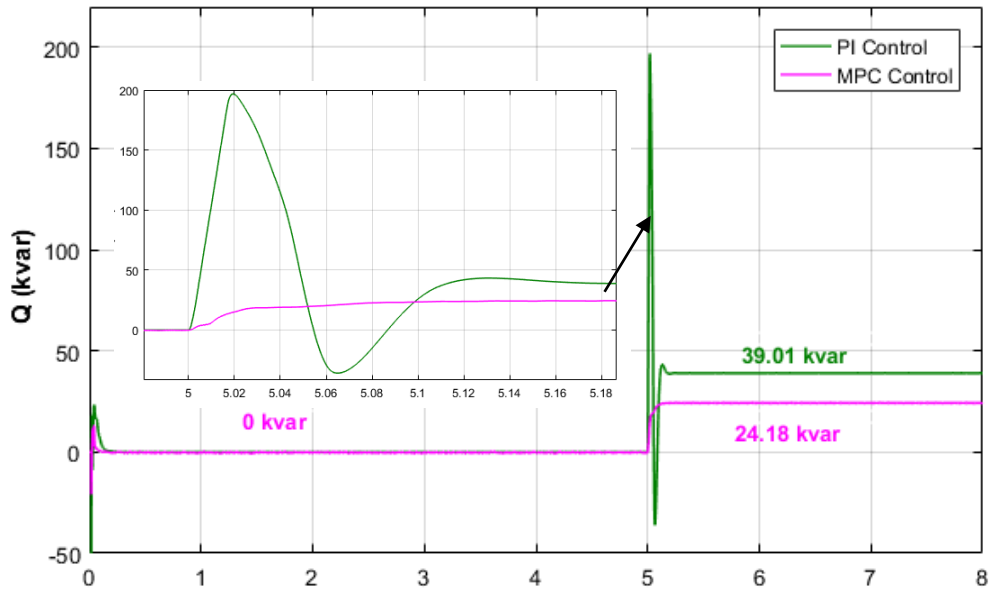

Fig.3. Inverter control scheme.



(a)



(b)

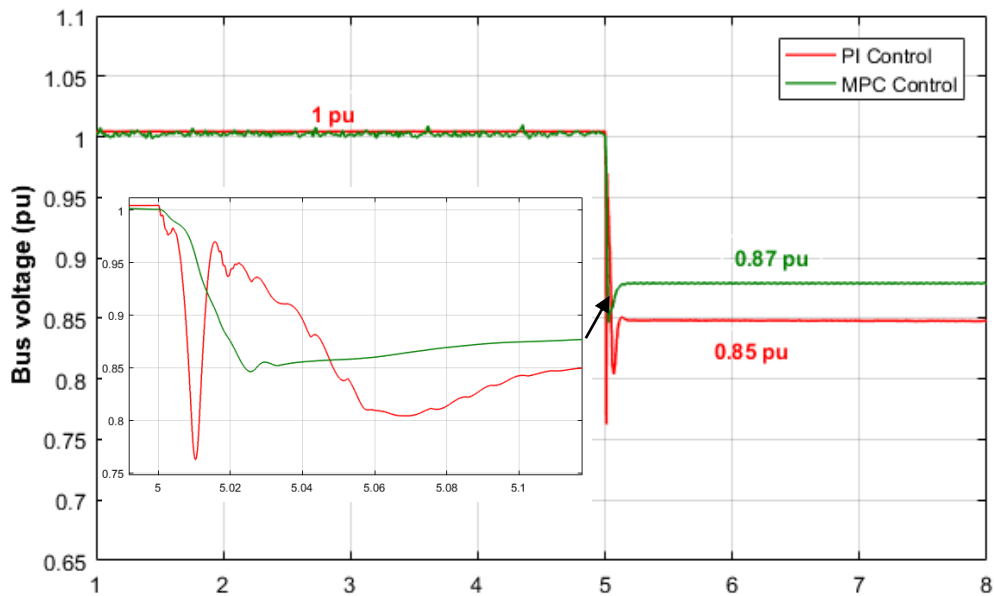

(c)

Fig.4 under-voltage conditions in reactive power control (a) Active power (b) Reactive power (c) Bus voltage

### Case 2: over-voltage

The increasing of the secondary of the transformer by using three winding transformers at  $t = 5$  sec and held constant to examine how various controllers react to an over-voltage state. The real power, reactive power, and the voltage bus are shown in fig.5, the active power in fig .5(a) remains constant before and after under-voltage conditions is equal 100.3 kw by using MPC and PI controls. Fig .5(b)

are demonstrated the reactive power by using PI and MPC controls, the reactive power control absorbs the reactive power at over-voltage conditions because to maintain the bus voltage operated near reference voltage, the amount of reactive power reduce from 39.1kVAR to 32.5 kVAR (16.9 percent) when using MPC control. Finally in fig.5(c) show the bus voltage connected the PV system with a grid, the voltage bus enhances by 4.25 percent when using the MPC control.

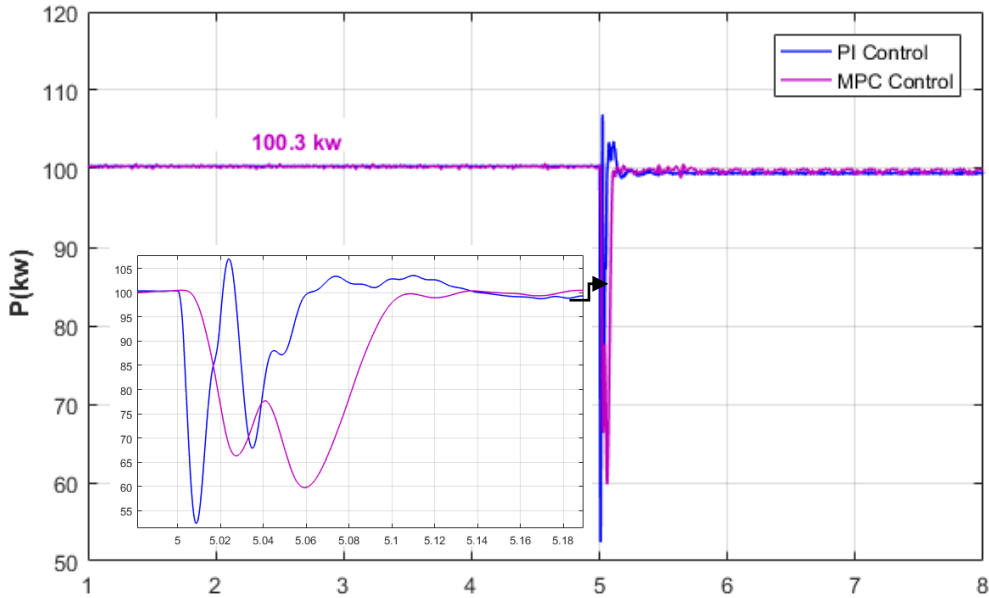

(a)

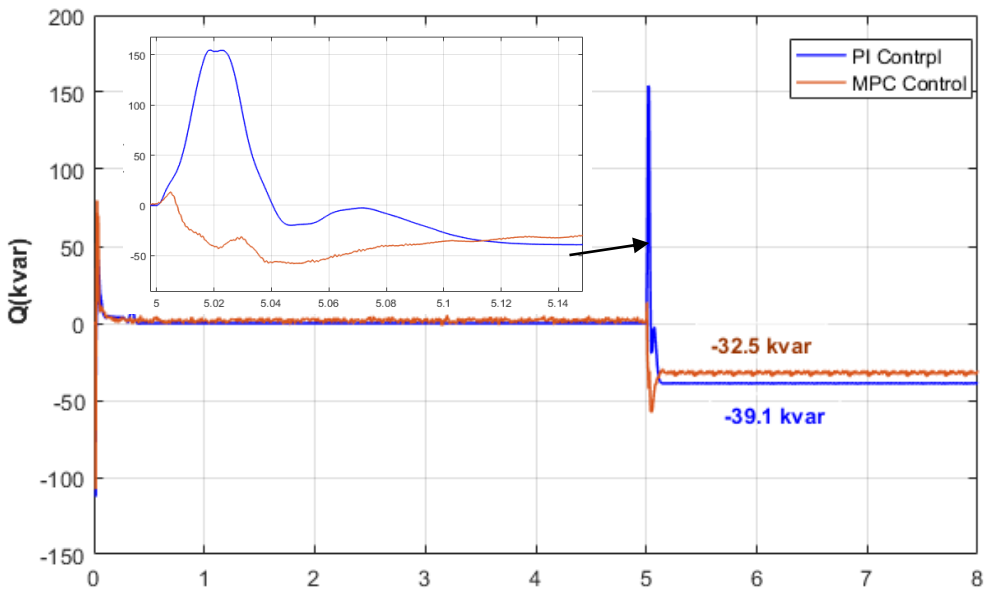

(b)

**Case 3: Increase hosting capacity in PV system.**

The smart inverter technique enables the expansion of PV systems connected to the grid. This research paper focuses on the utilization of reactive power control to ensure that the bus voltage remains equal to the reference voltage, allowing for the maximum number of solar systems to be connected without adversely affecting the normal operation of the system. Fig. 6 illustrates the Hosting Capacity (HC) improvement achieved through reactive power control. In Fig. 6(a), the active power in the

solar system remains constant at 100 kW until the PV generation is increased to 146.32 kW at t=5 sec. At this point, the inverter control absorbs reactive power of 39.02 kVAR to maintain the bus voltage near the reference value and prevent voltage fluctuations. The HC enhancement can be calculated using equation (2), resulting in a 46.32 percent improvement in the system, as per the equation (2).

Equation of hosting capacity enhancement

$$HC \text{ Enhancement } \% = \left| \frac{HC_{with} - HC_{without}}{HC_{without}} \right| * 100 \quad (2)$$

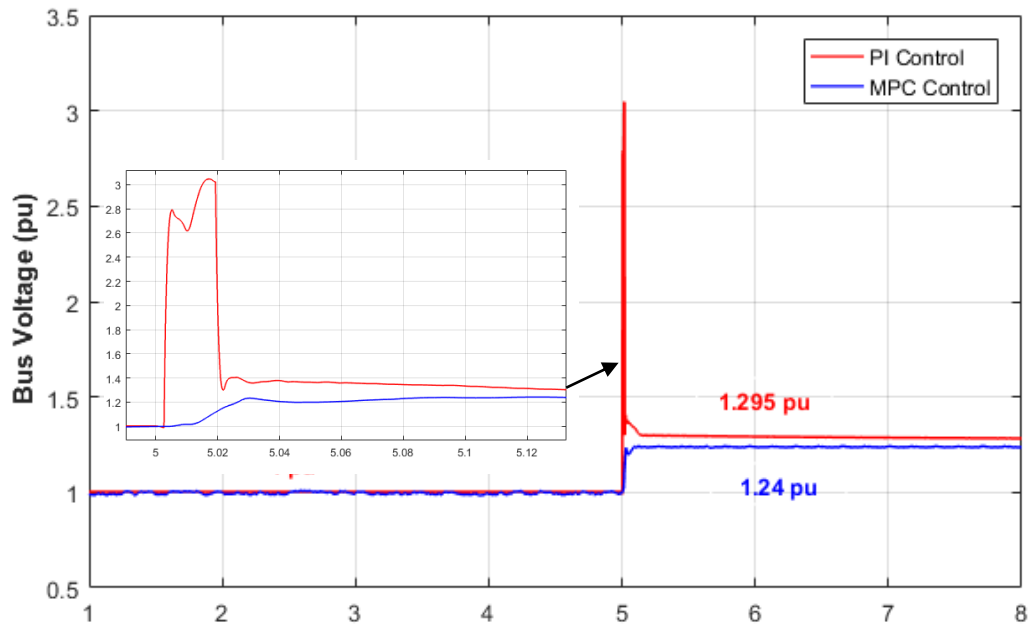

(c)

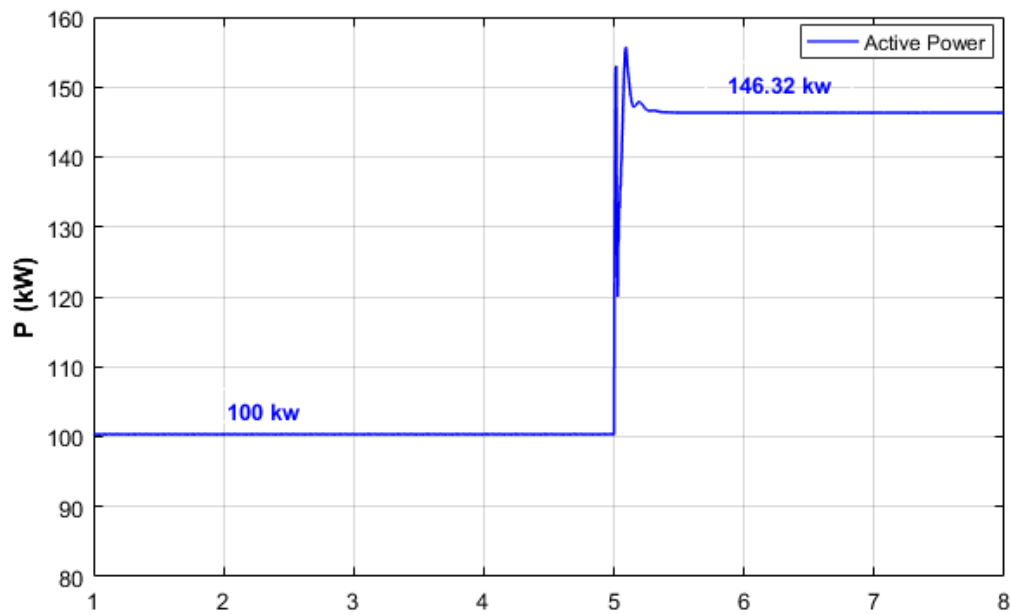
**Fig.5:** over-voltage conditions in reactive power inverter control (a) Active power (b) Reactive power (c) Bus voltage

(a)

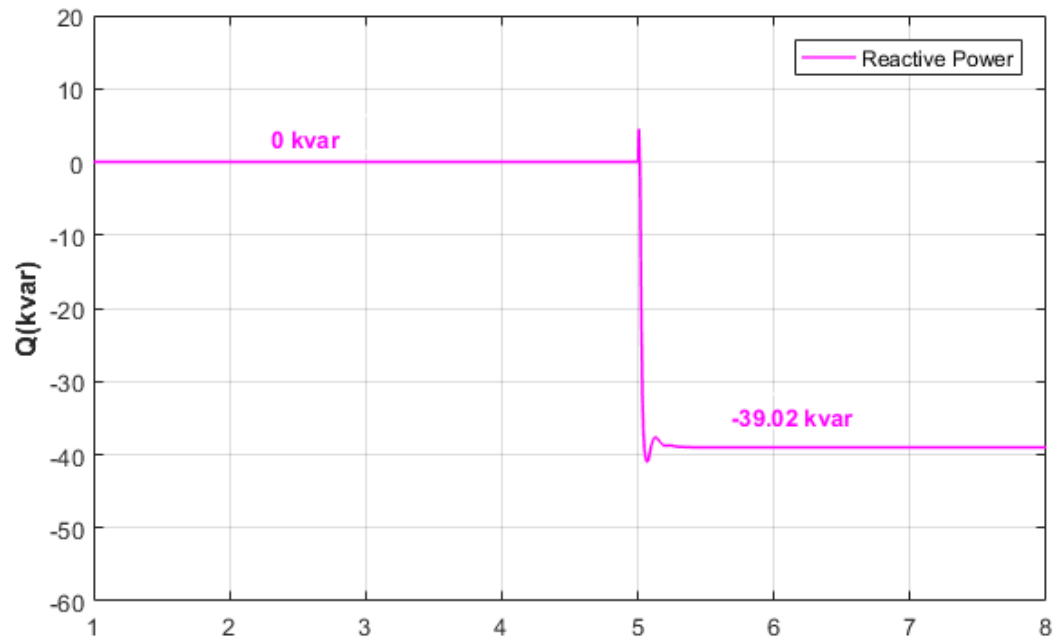

(b)

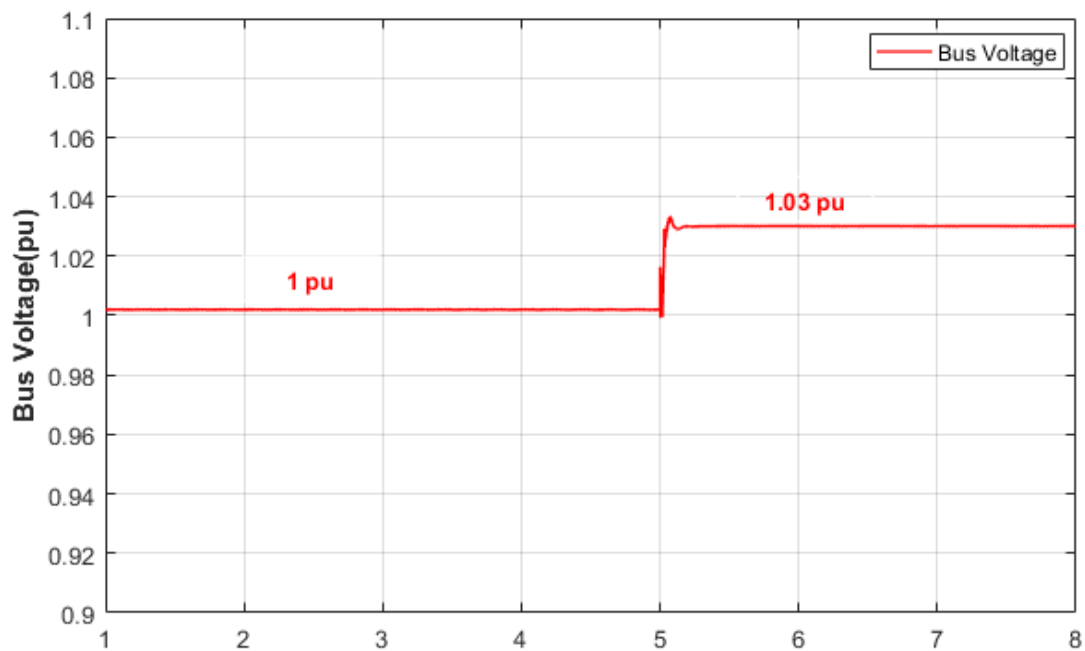

(c)

Fig. 6: Results in HC enhancement by using reactive power inverter control (a) active power (b) reactive power (c) bus voltage.

## 5- Conclusion

This research paper examines the impact of increasing PV solar system integration with the grid on voltage profile, specifically in cases of over-voltage and

under-voltage. Smart inverters play a crucial role in maintaining the bus voltage in PV systems connected to the grid. One type of smart inverter control is reactive power control, which is employed in both over-voltage and under-voltage scenarios. In over-voltage situations, it



operates as an inductive load, absorbing reactive power to safeguard the system against voltage fluctuations and over-voltage issues. Conversely, in under-voltage conditions, it acts as a capacitive load, injecting reactive power to maintain the voltage profile.

This paper provides a comparison between PI and MPC control methods. The results demonstrate that the utilization of MPC control reduces losses, overshoot, and voltage profile fluctuations. The Hosting Capacity (HC) improvement achieved with the implementation of reactive power control reaches 46.32% without affecting the normal operation of the system.

## References

- [1] L. Al-Ghussain, "Global warming: review on driving forces and mitigation," *Environ. Prog. Sustain. Energy*, vol. 38, no. 1, pp. 13–21, 2019, doi: 10.1002/ep.13041.
- [2] T. M. Letcher, *Why do we have global warming?* Elsevier Inc., 2018. doi: 10.1016/B978-0-12-814104-5.00001-6.
- [3] I. Wallimann-Helmer, *Justice in managing global climate change*. Elsevier Inc., 2018. doi: 10.1016/B978-0-12-814104-5.00026-0.
- [4] I. Hamdan, A. Alfouly and M. A. Ismeil, "Hosting Capacity Enhancement for Photovoltaic Systems at Various Conditions Based on Volt-Var Control," *23rd Int. Middle East Power Syst. Conf. (MEPCON), Cairo, Egypt, 2022*, 2022, doi: 10.1109/MEPCON55441.2022.1002.
- [5] J. Jurasz, F. A. Canales, A. Kies, M. Guezgouz, and A. Beluco, "A review on the complementarity of renewable energy sources: Concept, metrics, application and future research directions," *Sol. Energy*, vol. 195, no. April 2019, pp. 703–724, 2020, doi: 10.1016/j.solener.2019.11.087.
- [6] "Renewable Energy Market Update," *Renew. Energy Mark. Updat.*, 2022, doi: 10.1787/faf30e5a-en.
- [7] REN21, *Renewables 2022 Global Status*. 2022. [Online]. Available: <https://www.ren21.net/gsr-2022/>
- [8] A. M. Howlader, S. Sadoyama, L. R. Roose, and Y. Chen, "Active power control to mitigate voltage and frequency deviations for the smart grid using smart PV inverters," *Appl. Energy*, vol. 258, no. April 2019, p. 114000, 2020, doi: 10.1016/j.apenergy.2019.114000.
- [9] S. Fatima, V. Püvi, and M. Lehtonen, "Review on the PV hosting capacity in distribution networks," *Energies*, vol. 13, no. 18, 2020, doi: 10.3390/en13184756.
- [10] J. F. B. Sousa, C. L. T. Borges, and J. Mitra, "PV hosting capacity of LV distribution networks using smart inverters and storage systems: A practical margin," *IET Renew. Power Gener.*, vol. 14, no. 8, pp. 1332–1339, 2020, doi: 10.1049/iet-rpg.2019.1054.
- [11] L. (EPRI) Rogers, J. (EPRI) Smith, H. (EPRI) Li, and W. (EPRI) Sunderman, "Smart grid inverters to support photovoltaics in New York distribution systems," *Epri*, no. June, pp. 15–18, 2015.
- [12] E. Mulenga, M. H. J. Bollen, and N. Etherden, "A review of hosting capacity quantification methods for photovoltaics in low-voltage distribution grids," *Int. J. Electr. Power Energy Syst.*, vol. 115, no. June 2019, p. 105445, 2020, doi: 10.1016/j.ijepes.2019.105445.
- [13] D. Chathurangi, U. Jayatunga, S. Perera, A. P. Agalgaonkar, and T. Siyambalapitiya, "Comparative evaluation of solar PV hosting capacity enhancement using Volt-VAr and Volt-Watt control strategies," *Renew. Energy*, vol. 177, pp. 1063–1075, 2021, doi: 10.1016/j.renene.2021.06.037.
- [14] A. Rajabi, S. Elphick, J. David, A. Pors, and D. Robinson, "Innovative approaches for assessing and enhancing the hosting capacity of PV-rich distribution networks: An Australian perspective," *Renew. Sustain. Energy Rev.*, vol. 161, no. October 2021, p. 112365, 2022, doi: 10.1016/j.rser.2022.112365.
- [15] A. Sinha and P. Modelling, *William Holderbaum Feras Alasali Ayush Sinha*.
- [16] E. T. Maddalena, C. G. S. da Moraes, G. Waltrich, and C. N. Jones, "A neural network architecture to learn explicit MPC controllers from data," *IFAC-PapersOnLine*, vol. 53, no. 2, pp. 11362–11367, 2020, doi: 10.1016/j.ifacol.2020.12.546.
- [17] H. S. V. S. K. Nunna, B. Azibek, A. Khamitov, P. K. Jamwal, A. K. Rathore, and S. Doolla, "Increasing Hosting Capacity of Distribution Networks by Microgrid Reactive Power Management," *2020 IEEE Int. Conf. Power Electron. Smart Grid Renew. Energy, PESGRE 2020*, pp. 5–10, 2020, doi: 10.1109/PESGRE45664.2020.9070727.
- [18] E. Kabalcı, "Review on novel single-phase grid-connected solar inverters: Circuits and control methods," *Sol. Energy*, vol. 198, no. October 2019, pp. 247–274, 2020, doi: 10.1016/j.solener.2020.01.063.
- [19] A. K. Podder, N. K. Roy, and H. R. Pota, "10.1049@Iet-Rpg.2018.5946," no. 1, pp. 1–15.
- [20] M. Bajaj and A. Kumar Singh, "Hosting capacity enhancement of renewable-based distributed generation in harmonically polluted distribution systems using passive harmonic filtering," *Sustain. Energy Technol. Assessments*, vol. 44, no. January, p. 101030, 2021, doi: 10.1016/j.seta.2021.101030.
- [21] B. Seal and B. Ealey, "Common Functions for Smart Inverters: 4th Edition," *Epri*, p. 170, 2016.
- [22] S. Mohan, S. Hasan, Y. Gebremariam, and R. K. Varma, "Increasing Hosting Capacity of PV Solar Systems using Smart Inverter Volt-Var Control," *2018 20th Natl. Power Syst. Conf. NPSC 2018*, pp. 1–6, 2018, doi: 10.1109/NPSC.2018.8771749.
- [23] IEEE Std 1547, *IEEE Standard for Interconnection and Interoperability of Distributed Energy Resources with Associated Electric Power Systems Interfaces*. 2018.
- [24] S. Sakar, M. E. Balci, S. H. E. A. Aleem, and A. F. Zobiaa, "Hosting capacity assessment and improvement for photovoltaic-based distributed generation in distorted distribution networks," *EEEIC 2016 - Int. Conf. Environ. Electr. Eng.*, pp. 2–7, 2016, doi: 10.1109/EEEIC.2016.7555515.