

**Military Technical College  
Kobry El-Kobbah,  
Cairo, Egypt**



**6<sup>th</sup> International Conference  
on Electrical Engineering  
ICEENG 2008**

## **UAV Classical Flight Control Systems**

*By*

*Elfatih J. Hamdi \**

*Ahmed M. Youssef \*\**

*Gamal A. Elshiekh \*\*\**

### **Abstract:**

One of the attractive and challenging design problems is the Unmanned Air Vehicle (UAV) where the flight control system is designed to achieve robust stability and acceptable performance across specified flight envelope in the presence of uncertainties. Therefore, this paper is devoted to design adequate automatic flight control systems in order to stabilize the attitudes and natural modes of a flying fixed wing (**Aerosonde**) UAV under exogenous disturbances. Toward this objective, a nonlinear mathematical model for the underlying aircraft is developed and linearized yielding a state-space model. This linear model is then decoupled into two smaller models associated to the longitudinal and lateral motions of the aircraft. The natural modes for both motions are analyzed by initializing the system matrix with the real parts of eigenvector corresponding to each mode. Classical PID tuning techniques have been utilized with the longitudinal model to design flight control systems that achieve the performance requirements; including good tracking and the rejection of disturbances.

### **Keywords:**

UAV, Flight Control, Classical Control Techniques

---

\* Msc. Student, Military Technical College, Cairo, Egypt

\*\* Military Technical College, Cairo, Egypt

\*\*\* Silicon Valley Academy, Cairo, Egypt

## 1. Introduction:

One of the main problems in design of flight control systems is to understand the aircraft dynamics and its operation environments. In fact, an aircraft in flight is very complicated dynamic system; due to the high nonlinear modes those are included. Moreover, wide changes in flight conditions try to alter the aerodynamic parameters. Nevertheless, holding an aircraft, within specific attitude, is so difficult process in the presence of high frequencies modes (short period, roll, and dutch roll modes) and low frequencies modes (long period/phugoid, and spiral modes) [1]. This requires achieving constant and continuously efforts to correct the aircraft toward its desire attitude [2]. The correction process should be as smooth as possible and comfortable without significant overshoot or exceeding time domain constraints, and remain within limitations of the airframe. To address these problems, flight control systems are designed utilizing with the several schools of thoughts yielding different techniques grouped according to their functions into: classical techniques and advanced techniques. For the purpose of this paper, a classical time domain design, namely PID tuning, is chosen.

This paper organized as follows: In section 1, an introduction about the nature of the problem is presented. Section 2 is devoted to the generalized 6DOF nonlinear model. In section 3 a decoupled linear submodels are obtained for longitudinal and lateral motions. In section 4 the aircraft natural motion is analyzed interms of longitudinal and lateral modes by initializing their system matrices with the real parts eigenvectors corresponding to each mode. Section 5 represented the flight control systems setup in which pitch angle attitude hold autopilot is designed utilizing the SDOF and TDOF structures. From analysis, the TDOF structure showed better tracking and disturbance rejection than the SDOF one. Finally, this paper concludes with a brief summary in section 6.

## 2. Mathematical Model:

In order to design a perfect flight control systems with the high quality of performance, it is necessary to perform several flight tests, which require building a high cost real aircraft [3]. Thus to reduce the number of flight tests, a mathematical model for the aircraft is developed and analyzed and flight control systems are designed utilizing available computer tools. A generalized full six degrees of freedom (6DOF) nonlinear mathematical model of a rigid symmetric aircraft that proof in [1, 4, and 5] can be written, according to [5] notations, as follows:

$$X_A + X_G + X_T = m (\vec{U} + WQ - VR) \quad (1)$$

$$Z_A + Z_G + Z_T = m (\vec{W} + VP - UQ) \quad (2)$$

$$Y_A + Y_G + Y_T = m (\vec{V} + UR - WP) \quad (3)$$

$$L_A + L_G + L_T = \vec{P}I_{xx} + QR(I_{zz} - I_{yy}) - (\vec{R} + PQ)I_{xz} \quad (4)$$

$$M_A + M_T + M_T = \vec{Q}I_{yy} + PR(I_{xx} - I_{zz}) + (P^2 - R^2)I_{xz} \quad (5)$$

$$N_A + N_T + N_T = \vec{R}I_{zz} - \vec{P}I_{xz} + PQ(I_{yy} - I_{xx}) - QR I_{xz} \quad (6)$$

$$\vec{\phi} = P + (\sin \phi \tan \theta)Q + (\cos \phi \tan \theta)R \quad (7)$$

$$\vec{\theta} = \cos \phi Q - \sin \phi R \quad (8)$$

$$\vec{\psi} = \sin \phi \sec \theta Q + \cos \phi \sec \theta R \quad (9)$$

Where: (1 ~ 3) force equations, (4 ~ 6) moments equations, (7 ~ 9) kinematic equations. Clearly, they are non-linear, coupled differential equations describe the behavior of a rigid aircraft.

### 3. Linear Model:

According to the aerodynamic stability and control derivatives associated to the Aerosonde UAV, which can be found in [6], the aircraft is linearized around the following flight conditions [7]:

- Trim airspeed = 23 m/s
- Trim altitude = 200 m
- Trim bank angle = 0
- Fuel mass = 2 kg
- Flap setting = 0

Moreover, the linear state space model is obtained in terms of Jacobian matrices. By using some aerodynamic assumptions [5], the linear model is decoupled into two submodels associated to the longitudinal and lateral dynamics as follows:

#### Longitudinal Dynamic

$$A_l = \begin{bmatrix} -0.2197 & 0.6002 & -1.4884 & -9.7965 \\ -0.5820 & -4.1201 & 22.4025 & -0.6461 \\ 0.4823 & -4.5281 & -4.7508 & 0 \\ 0 & 0 & 1.0000 & 0 \end{bmatrix} \quad B_l = \begin{bmatrix} 0.3246 \\ -2.1518 \\ -29.8191 \\ 0 \end{bmatrix}$$

#### Lateral Dynamic

$$A_l = \begin{bmatrix} -0.6373 & 1.5136 & -22.9499 & 9.7965 \\ -4.1915 & -20.6265 & 9.9274 & 0 \\ 0.6798 & -2.6755 & -1.0376 & 0 \\ 0 & 1.0000 & 0.0660 & 0 \end{bmatrix} \quad B_l = \begin{bmatrix} -1.2509 \\ -109.8282 \\ -4.3304 \\ 0 \end{bmatrix}$$

### 4. Natural Responses:

Referring to the references [4, 5, and 15], the eigenvalues and eigenvectors technique is used to analyzing the aircraft transient motion, because it enables to describe the dynamic stability [4]. With the reference to table (1), the eigenvalues of longitudinal state matrix reveal that there are two sets of complex poles: the low frequency lightly damped set, called long period (Phugoid) mode, and the high frequency well damped set called short period mode.

Table (1): Characteristics of Longitudinal dynamic stability

Mode	Eigenvalue	Damping Ratio	Natural Frequency
Long Period (Phugoid)	$-0.1117 \pm 0.5966i$	0.184	0.607
Short Period	$-4.4336 \pm 10.1007i$	0.402	11

By the same manner, the eigenvalues of lateral state matrix, table (2), shows there are two real poles and set of complex pole. The negative real pole, -19.7247, is corresponding to the roll subsidence mode, the positive real pole, 0.0611, is corresponding to the spiral mode, and the complex set is

corresponding to the dutch roll mode

Table (2): Characteristics of Lateral dynamic stability

Mode	Eigenvalue	Damping Ratio	Natural Frequency	Time Constant
Roll	-19.7247	-	-	0.035
Spiral	0.0611	-	-	11.293
Dutch Roll	$-1.3189 \pm 5.5957i$	0.229	5.75	-

To visualize these modes, the longitudinal and lateral state matrices are excited with the real parts of eigenvectors corresponding to the eigenvalues of each mode [4, 5, and 15] the result is shown in the figure (3):

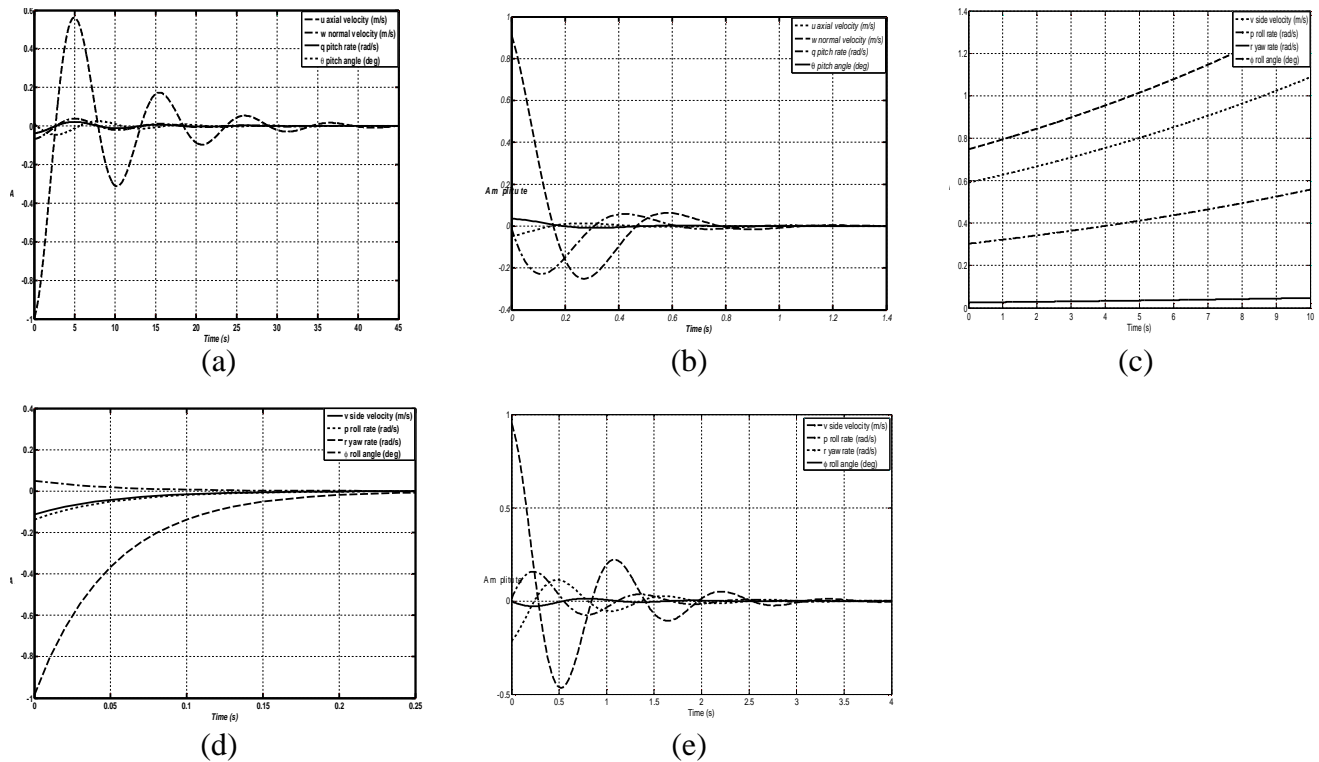

Figure (1): Open Loop Natural Response (a) Phugoid mode (b) Short period mode (c) Spiral mode (d) Roll mode (e) Dutch roll mode

Recalls to the figure (1), the aircraft natural (transient) modes shape are governed by the eigenvectors and eigenvalues. The important of this analysis is to gain insight into the physical properties governed the response, that is for it ability to visualize the contents of motion variables included in each mode. Based on this, the following results are gained:

1. Phugoid mode is stable and well observed in axial velocity state figure (1.a)
2. Short period mode is stable and well observed in normal velocity, and pitch rate states figure (1.b)
3. Spiral mode is unstable and well observed in normal velocity, roll rate, and roll angle figure (1.c) a
4. Roll subsidence mode is stable and well observed in normal velocity, roll rate, and yaw rate figure (1.d)
5. Dutch roll mode is well observed in normal velocity, roll rate, and yaw rate figure (1.e)

### 5. Flight Control Systems Setup

The main role of flight control systems is to make the aircraft to follow the reference command. Generally they are grouped, according to their function, into [1]:

1. Stability augmentation system (roll, pitch, and yaw dampers)
2. Control augmentation system (roll rate, pitch rate, normal acceleration, and lateral/directional)
3. Autopilot
  - 3.1. Pitch attitude hold
  - 3.2. Altitude hold
  - 3.3. Mach hold
  - 3.4. Automatic landing
  - 3.5. Bank angle hold
  - 3.6. Turn coordination
  - 3.7. Heading hold/VOR hold

For more details, please review [1, 5]. The fundamental task in controlling an aircraft is to control its attitude to the commanded motions [5]. For purposes of this paper, the pitch angle attitude hold autopilot is designed stabilized the aircraft longitudinal motion [1, 5, and 7].

#### 5.1 SDOF Pitch Angle Control

This controller is summarized in the figure (2).

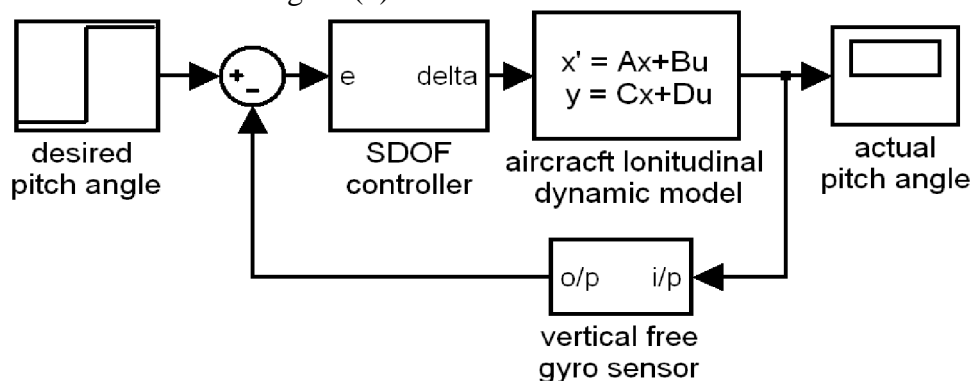

Figure (2): SDOF controller

The pitch angle is well controlled using an elevator deflection (delta) [4, 5]. The problem is to find a stabilizing and proper controller such that:

$$\delta(t) = K_p e(t) + K_i \int e(t) dt + K_d e(t) \quad (10)$$

Subjected to the:

$$\dot{\bar{x}} = A_l \bar{x} + B_l \delta \quad (11)$$

The output vector **C** is set to extract the pitch angle state in degree. The open loop response can be seen in the figure (3). The objective is to find a PID controller to achieve rise time less than 3 second; overshoot is less than 20 percentage, and zero steady state error. The Z-N tuning technique was used to design the controller for evaluation purposes [8]. It can be classified into: closed loop (oscillation) method and open loop (transient response/ or root locus) methods, more details will be found in [9, 10, and 11]. In this paper, Z-N open loop, root locus, is used. Therefore, from the root locus of open loop system, figure (4), the following parameters are found:

Gain  $k_c = 3.3776$

Frequency  $\omega_c = 6.1025$  rad/s

With this frequency, the period  $T_c$  is calculated as:

$$T_c = \omega_c / 2 * \pi = 6.1025 / 2 * \pi = 1.0296$$

Placing the values of  $k_c$  and  $T_c$  into Z-N table (3) below:

Table (3): Z-N PID tuning parameters

Controller	Kp	Ti	Td
PID	$0.6k_c$	$T_c/2$	$T_c/8$

The following PID controller parameters are calculated:

$$K_p = 2.6653, \quad K_i = 4.2287, \quad K_d = 0.4200$$

And closed loop response is seen in the figure (5). The controller parameters that are found, utilizing Ziegler-Nichol tuning, taken as initial guests and optimized using GA optimization technique under constraints of performance specifications.

$$K_p = 9.1260, \quad K_i = 2.8188, \quad K_d = 0.7743$$

And the closed loop response is shown in the figure (5).

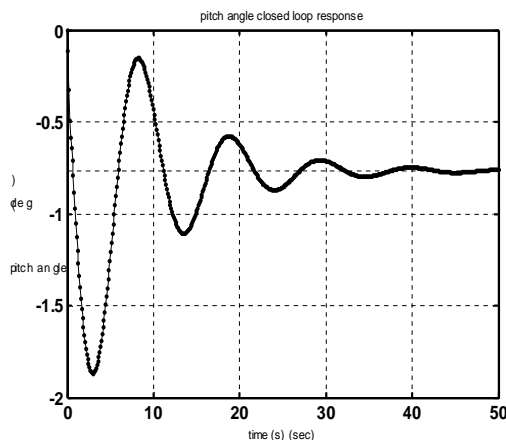

Figure (3): open loop response

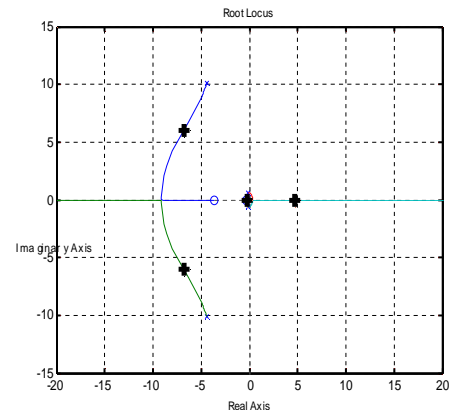

Figure (4): root locus of open loop system

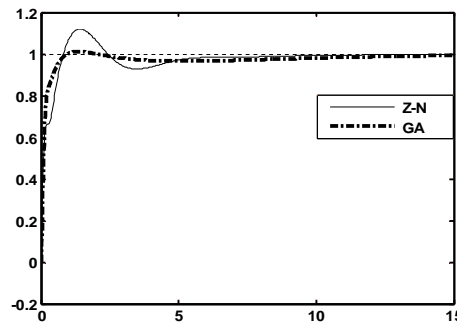

Figure (5): SDOF closed loop response

### 5.2 TDOF Pitch Angle Control

In order to reduce the effect of disturbances and at the same time improving tracking performance, a two degree of freedom (TDOF) controller is designed, for more details see [1,12,13,14]. This controller is summarized in the figure (6). TDOF controller is partitioned into two blocks: feedback controller (SDOF) that has been designed and prefilter to shape the pitch angle reference command to achieve good tracking performance. The prefilter is designed by iterative simulation of the pitch angle response until satisfactory shape is obtained. Therefore, a prefilter found to work well has the following parameters:

$$T= 60, \quad K=200.$$

The closed loop response is shown in the figure (7).

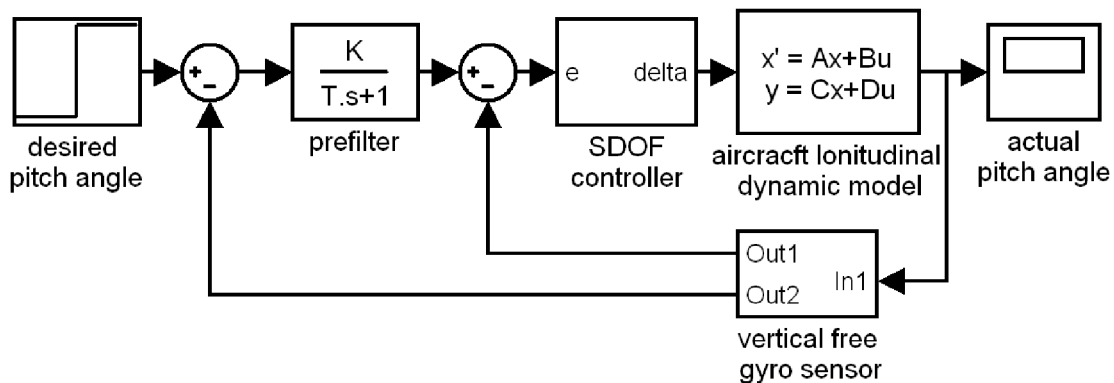

Figure (6): TDOF controller

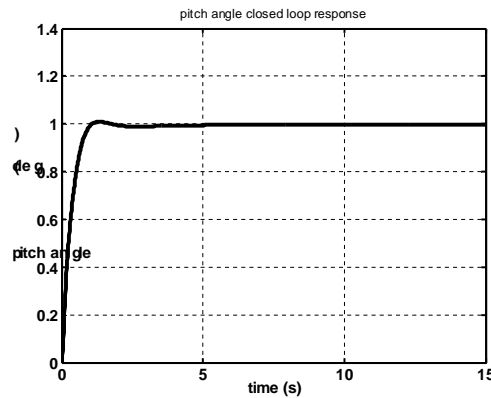

Figure (7): TDOF closed loop response

### 5.3 Controller Evaluation

The SDOF and TDOF pitch angle hold controllers obtained in last section are evaluated in terms of performance requirements and robustness against output disturbances. In terms of performance: they showed good tracking to the command reference and all the specifications have been met, figures (5), (7) and table (5). Moreover, both of them, also, showed a good rejection to the output step disturbance figures (8) and (9). A comparison between the SDOF and the TDOF in terms of disturbance is made and recorded in the table (4).

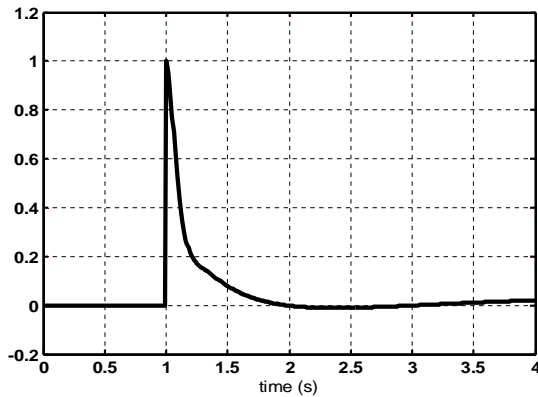

Figure (8): Step Disturbance Response using SDOF controller

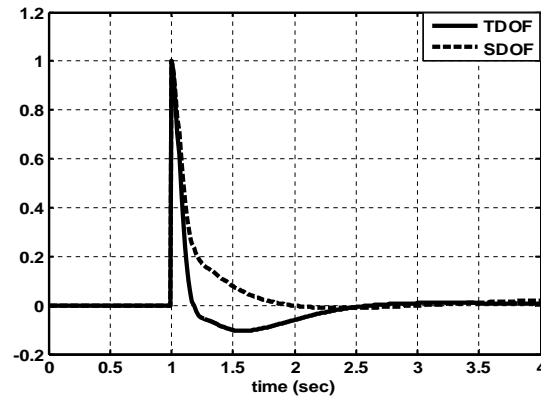

Figure (9): Step Disturbance Response using SDOF and TDOF

Table (4): analysis of disturbance Rejection for SDOF and TDOF

Disturbance Rejection	Time (sec)	
	SDOF	TDOF
50%	1.0955	1.0739
95%	1.6067	2.0699

In the other hand, the controllers are evaluated in terms of performance levels in different setting as shown the table (5). It is obviously that the control system designed using TDOF provide good tracking performance, table (5), and good disturbance rejection, figure (8), than the one that is designed



using SDOF, but the STOF controller is smoother in disturbance rejection, figure (8), than the TDOF is.

Table (5): System Performance Levels in Different Settings

System Settings		Performance Levels			
		Rise Time (s)	Peak Time (s)	Settling Time (s)	Overshoot %
Open Loop		0.498	2.97	36	144
SDOF	Z-N	0.4984	1.409	5.55	11.9
	GA	0.2108	1.33	9.75	1.93
TDOF		0.68	0.98	0.647	1.14

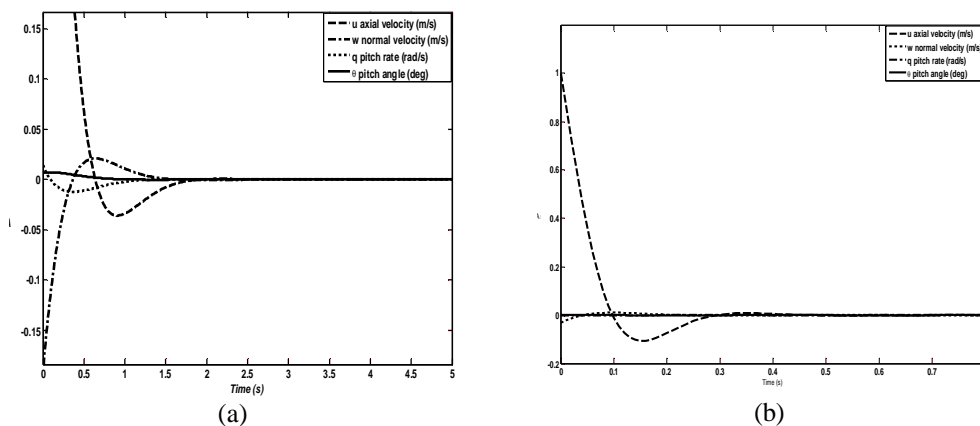

Figure (10): Closed Loop Natural Response  
(a) Phugoid Mode (b) Short Period Mode

The closed loop phugoid and short period modes in figures (11.a and 11.b) are compared with that for the open loop one in figures (3.a and 3.b). The closed loop system showed that these modes are much more heavily damped than that of the open loop system. In the open loop system, the phugoid and short period modes are well damped within 45 second and 1.4 second respectively, but when using the closed loop system, they heavily damped within 2.9 second and 0.48 second respectively.

## 6. Conclusions:

In this paper, several issues in flight control systems design are presented including: generalized 6DOF nonlinear and linear models are obtained, and the aircraft natural modes are analyzed for both longitudinal and lateral motions. This analysis enables to visualize which states comprise each mode. In the light of this, pitch attitude hold autopilot is designed to control the aircraft motion in longitudinal channel. In achieving our goals, two structures of the controller are considered: the SDOF controller and the TDOF. The SDOF controller is first designed, using Z-N tuning, and then the controller parameters are taken as initial guesses and optimized using GA optimization technique under performance specifications. Then TDOF controller is designed utilizing the SDOF controller for good disturbance rejection and the prefilter to shape reference command for good tracking performance. The comparison between two controller structures showed that the TDOF structure is much better than the SDOF structure in terms of tracking performance and disturbance rejection, but SDOF is smoother in disturbance rejection. Moreover, the controller has been designed stabilized both phugoid and short period modes.

**References:**

- [1] Steven, B.L. and F.L. Lewis, ' Aircraft Control and Simulation', John Wiley & sons, 1992
- [2] Greg Wolodkin, Karen Gondoly, and Pascal Gahinet, ' Auto-pilot Design using Simulink and stem Toolbox '
- [3] Ahmed Medhat Mohamed, 'Robust Flight Control System design', M.sc thesis, MTC, Cairo, 1998
- [4] M.V. Cook. ' Flight Dynamics Principles ', 1997
- [5] Iain K. Peddle, ' Autonomous Flight of a Model Aircraft', M.sc thesis, University of Stellenbosch, 2005
- [6] Flight Dynamic web page: [www.u-dynamics.com](http://www.u-dynamics.com)
- [7] AeroSim User's Guide version 1.2
- [8] IAN Griffin, ' on line PID controller tuning using genetic algorithm', M,Sc, 2003
- [9] Ogata K. 'Modern Control Engineering', Prentice Hall, Forth Edition
- [10] Dingyu Xue, YangQuan Chen, and Derek P. Atherton 'Linear Feedback Control
- [11] Control Tutorials for Matlab web page: <http://www.engin.umich.edu/group/ctm/home.text.html>
- [12] Da-Wei Gu, Petko H. Petkov and Mihail M. Konstantinov ' Robust Control Design with MATLAB'
- [13] Jean-Francois Magni, Samir Bennani, Jan Terlouw (Eds) 'Robust Flight Control: A design Challenge
- [14] Sigurd Skogestad Ian Postlethwaite, 'Multivariable Feedback Control analysis and design', first and second editions
- [15] Arthur E. Bryson, Jr. ' Control of Spacecraft and Aircraft '. Princeton University Press, 1994

**Nomenclatures:**

A, B, C, D	matrices used in the state space description	I <sub>xx</sub> , I <sub>yy</sub> , I <sub>zz</sub>	moment of inertia about each axis
x, δ	state, and control vectors respectively	I <sub>yz</sub> , I <sub>zx</sub> , I <sub>xy</sub>	product of inertia
δ <sub>e</sub> , δ <sub>r</sub> , δ <sub>a</sub> , δ <sub>t</sub>	elevator, rudder, aileron, and throttle	θ, φ, ψ	Euler angles ( <i>pitch, roll, yaw</i> )
X <sub>A</sub> , Y <sub>A</sub> , Z	aerodynamic force components ( <i>axial, side, normal</i> )	SDOF	single degree of freedom
X <sub>G</sub> , Y <sub>G</sub> , Z <sub>G</sub>	gravity force components ( <i>axial, side, normal</i> )	TDOF	two degree of freedom
X <sub>T</sub> , Y <sub>T</sub> , Z <sub>T</sub>	propulsive force components ( <i>axial, side, normal</i> )	Z-N	Ziegler Nichol
L <sub>A</sub> , M <sub>A</sub> , N <sub>A</sub>	aerodynamic moment components ( <i>rolling, pitching, yawing</i> )	GA	genetic algorithm
L <sub>G</sub> , M <sub>G</sub> , N <sub>G</sub>	gravity moment components ( <i>rolling, pitching, yawing</i> )	S <sub>i</sub>	Sin(i)
L <sub>T</sub> , M <sub>T</sub> , N <sub>T</sub>	propulsive moment components ( <i>rolling, pitching, yawing</i> )	C <sub>i</sub>	Cos(i)
U, V, W	total linear velocity components ( <i>axial, side, normal</i> )	m	mass
u, v, w	perturbation linear velocity components	τ	Time constant
P, Q, R	total angular velocity components ( <i>roll rate, pitch rate, yaw rate</i> )	K	Steady state gain
p, q, r	perturbation angular velocity components		