

**EGTRIB Journal**  
**JOURNAL OF**  
**THE EGYPTIAN SOCIETY OF TRIBOLOGY**

*VOLUME 21, No. 2, April 2024, pp. 39 – 52*    ISSN 2090 - 5882

*(Received December 23, 2023, Accepted in final form February 26, 2024)*    [jest.journals.ekb.eg](http://jest.journals.ekb.eg)

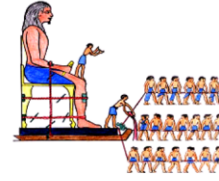

**FIBER REINFORCED POLYMER MATRIX COMPOSITES FOR  
ORTHOPAEDIC IMPLANTS**

**Eyad M. A., Mohamed M. K., Ali W. Y. and Badran A. H.**

Department of Production Engineering and Mechanical Design, Faculty of Engineering,  
Minia University, P. N. 61111, El-Minia, EGYPT.

**ABSTRACT**

Femur fractures, that are frequently caused by trauma or osteoporosis, present major issues due to their impact on mobility and quality of life. Despite the fact that metallic implants, such as titanium and stainless steel, are strong and biocompatible, they nonetheless raise issues with stress shielding, changed biomechanics, and diagnostic imaging limits. This study proposes biocompatible epoxy composites reinforced with kevlar fibers (KF), carbon fibers (CF), hybrid fibers, and flax as alternatives to metallic implants in order to overcome these constraints. We discovered that KF composites outperformed others in terms of mechanical properties, with an ultimate tensile strength of 283.5 MPa as well as flexural strengths of 35.7 MPa and 90.4 MPa for the first and second modes, respectively, at a volume fraction of 24%. Although flax fibers have the benefit of being natural, their performance has lagged. Carbon and hybrid fiber composites performed comparably to flax but not as well as kevlar. Notably, the presence of kevlar in hybrid composites increased performance when compared to carbon composites. While all composites lost 50 % of their ductility while shifting from the first to the second flexural mode. This was compensated by a considerable increase in flexural strength. These results indicate that, despite resolving issues with metallic implants, kevlar fiber-reinforced composites show potential as an alternative material for femur implants because of their better mechanical characteristics. For clinical translation, more investigation is necessary to optimize fiber combinations, improve composite architectures, and evaluate in vivo biocompatibility.

**KEYWORDS**

Orthopaedic implants, kevlar fibers, carbon fibers, hybrid fibers, flax, polymer composites, epoxy, tensile stress, flexural strength.

**INTRODUCTION**

The search for materials with better mechanical properties and biocompatibility has led to a notable advancement in the field of orthopaedic implants in recent years, [1, 2]. Conventional materials, including cobalt chrome, stainless steel, and titanium alloys, have been crucial in meeting the needs of load-bearing applications in the case

of Femur Plate Implants, Fig. 1. However, the investigation of innovative materials and composite systems has been prompted by the growing demand for implants with superior mechanical behavior, decreased weight, and better patient outcomes, [3 - 6]. Reinforcing polymer matrix composites (RPMCs) are a potentially fruitful direction in the search for cutting-edge orthopaedic implants, [7 - 9]. RPMCs have the ability to completely change the field of orthopaedic implant materials by fusing high performance fibers like carbon, flux, and kevlar with the desired properties of polymers, [10, 11]. The extraordinary mechanical capabilities imparted by the inclusion of those fibers into the polymer matrix allow the fabrication of implants that exceed the constraints of traditional materials, [12 - 17].

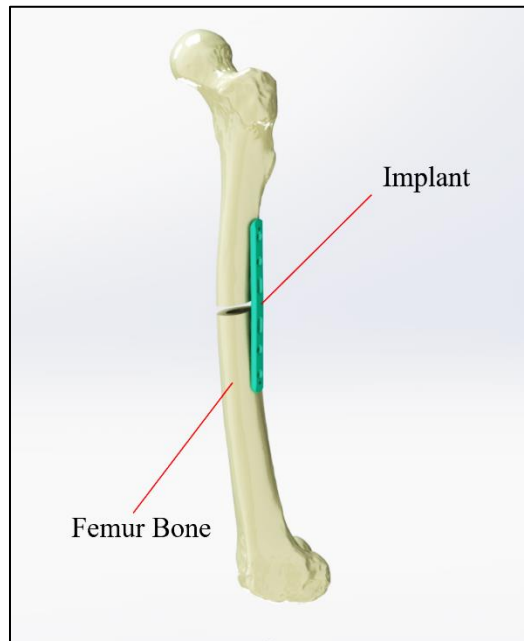

**Fig. 1 Illustration by SolidWorks shows the location of the femur bone with the implant.**

To guarantee orthopaedic implants dependability and durability throughout use, their mechanical behavior is crucial. The implant capacity to tolerate physiological loads and dynamic stresses experienced during daily activities is determined by many critical factors such as tensile strength, fatigue resistance, and flexural performance, [10, 11, 18]. An implant resistance to flexural stresses is a fundamental mechanical necessity. Flexural performance measures how well an implant can withstand the bending forces that come with normal human movement, [19 - 21].

In order to assess RPMCs potential as stand-ins for traditional materials, a thorough grasp of their mechanical performance in orthopaedic applications is essential. The purpose of this study is to examine the mechanical behavior of RPMCs reinforced by kevlar, flux, and carbon fibers for use in fixing femoral bone fractures using stabilizing plate implants. Through a thorough analysis of the composite implants flexural performance, important information about their appropriateness as

substitutes for traditional materials may be obtained. In addition to helping with implant material selection and optimization, an understanding of these RPMCs mechanical performance will open the door to better patient outcomes, more functioning implants, and fewer surgical problems.

## EXPERIMENTAL

### Biocompatible Epoxy Resins

The remarkable mechanical qualities, resistance to chemicals, and simplicity of processing of epoxy resins have made them popular in a variety of sectors. However, because of worries about their biocompatibility, their original uses were restricted to non-biological conditions. Researchers have successfully adapted epoxy resins to suit the strict standards of biocompatibility, opening up new pathways for its application within the human body through meticulous changes and breakthroughs in resin composition, [22 - 24].

The most important feature of biocompatible epoxy resin is its capacity to live in harmony with biological tissues without triggering cytotoxic reactions or unfavourable immunological reactions. A number of techniques are used to accomplish this compatibility, including as the use of biocompatible raw materials, the removal of hazardous additives, and the improvement of resin curing procedures. Since of these changes, the epoxy resin is a perfect fit for medical applications since it shows very little toxicity and keeps its structural integrity in a biological setting, [25, 26].

Table 1 mechanical properties of Epoxy Resins provided from supplier.

Property	Value
Tensile Strength (MPa)	179
Tensile modulus (GPa)	10.4
Elongation at Break (%)	-
Density (g/cm <sup>3</sup> )	1.1

Fig. 2 illustrates flax-woven fiber, that is both sustainable and adaptable. It is valued to its eco-friendly cultivation, biodegradability, and distinctive visual appeal, even if its mechanical strength is lesser than certain alternatives, [27].



Fig. 2 Flax-woven fabric is provided by Easy Composites.

Table 2 mechanical properties of Flax provided from manufacturer.

Property	Value
Tensile Strength (MPa)	61
Tensile modulus (GPa)	7
Elongation at Break (%)	1.5
Density (g/cm <sup>3</sup> )	1.45

The tensile strength and stiffness of CF, as seen in Fig. 3, are exceptional, outperforming many conventional materials such as metals and ceramics. CF are made of thin, high-strength carbon filaments. CF strengthen composites when they are incorporated into polymer matrices, improves their load-bearing capacity and yields remarkable strength-to-weight ratios, [17, 28].

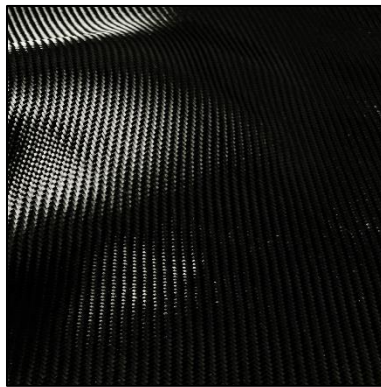
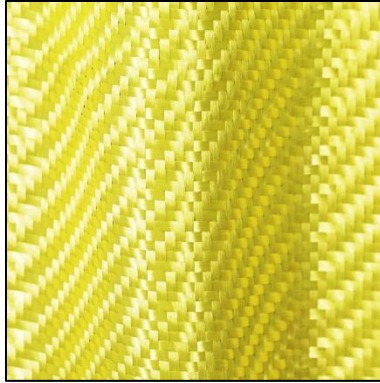

Fig. 3 CF woven fabric.

Table 3 mechanical properties of CF provided by manufacturer.

Property	Value
Tensile Strength (MPa)	3100
Tensile modulus (GPa)	230
Elongation at Break (%)	1.8
Density (g/cm <sup>3</sup> )	1.79

Conventional metallic implants frequently place an undue amount of weight and strain on the surrounding bone, which increases the risk of problems including stress shielding, implant failure, and bone resorption. KF composites, Fig. 4, offer an alternative by lowering the implant weight while preserving or perhaps enhancing its mechanical characteristics. This reduces stress on the bone, improves patient comfort, and makes rehabilitation more effective, [16].

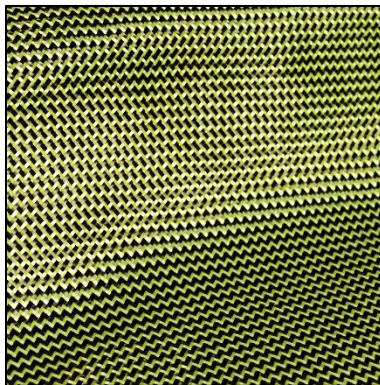

**Fig. 4 Kevlar-woven fabric.**

**Table 4 mechanical properties of Kevlar provided from manufacturer.**

<b>Property</b>	<b>Value</b>
<b>Tensile Strength (MPa)</b>	<b>3800</b>
<b>Tensile modulus (GPa)</b>	<b>131</b>
<b>Elongation at Break (%)</b>	<b>2.4</b>
<b>Density (g/cm<sup>3</sup>)</b>	<b>1.44</b>

A form of composite material that combines the qualities of both CF and KF is carbon-Kevlar hybrid woven fabric, Fig. 5. It is made by weaving strands made of carbon and Kevlar fibers in a certain pattern, which produces a fabric with improved mechanical properties.



**Fig. 5 Carbon-Kevlar fabric.**

### **Mechanical testing**

A number of mechanical tests are essential when evaluating novel materials for femur implants to make sure that the material is appropriate for the purpose. Tensile testing evaluates a material strength and ductility under tension in order to determine how it will react to pulling forces and how well it will tolerate stresses on the femur. Given the bending stresses the femur experiences during activities like walking and running, flexural testing assesses the material capacity to bend. Researchers and producers

may extensively assess the functionality, robustness, and biocompatibility of novel materials for femur implants through the application of these mechanical tests, guaranteeing the materials' safety and efficacy in clinical settings.

Due to the remarkable flexibility and extensive range of movement inherent in the human body, it is necessary to develop an implant capable of enduring such diverse stresses needed thorough examination from multiple angles. For instance, while the implant may encounter flexural, its susceptibility to this stress may vary significantly when the direction changes, Figs. 6 and 7. Merely altering the direction of stress by 90° can drastically influence the flexural forces that the implant can withstand. Universal material testing machine was used in its 3-point bending configuration, and the tests were carried out at strain rates of 10 mm/min.

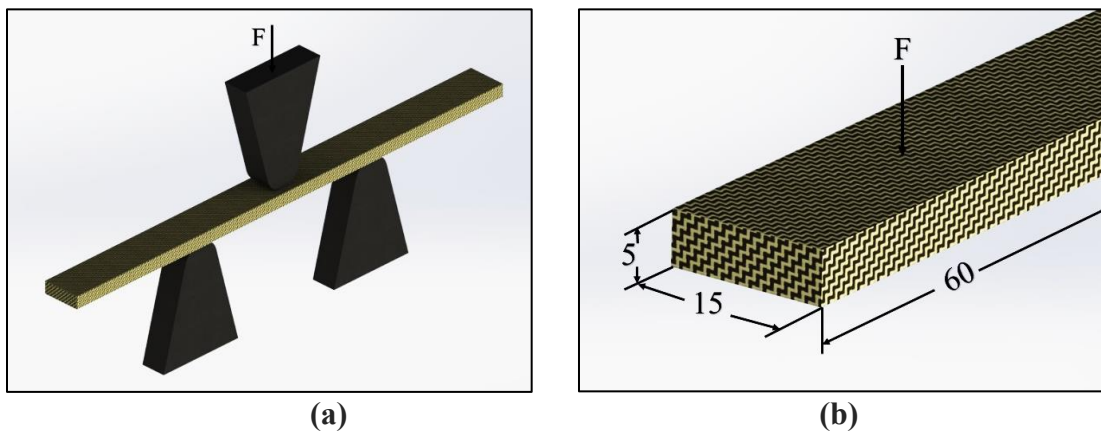

Fig. 6 Flexural test specimen according to ASTM D7264, Test mode 1. (a) Test configuration. (b) Flexural specimen Dimensions.

The governing equation for calculating the stress exerted on a rectangular test specimen, Test mode 1, when bending specimens in a 3-point bending configuration, it is as follows:

$$\sigma = \frac{3FL}{2bh^2} = \frac{3F60}{2(15)(5)^2}$$

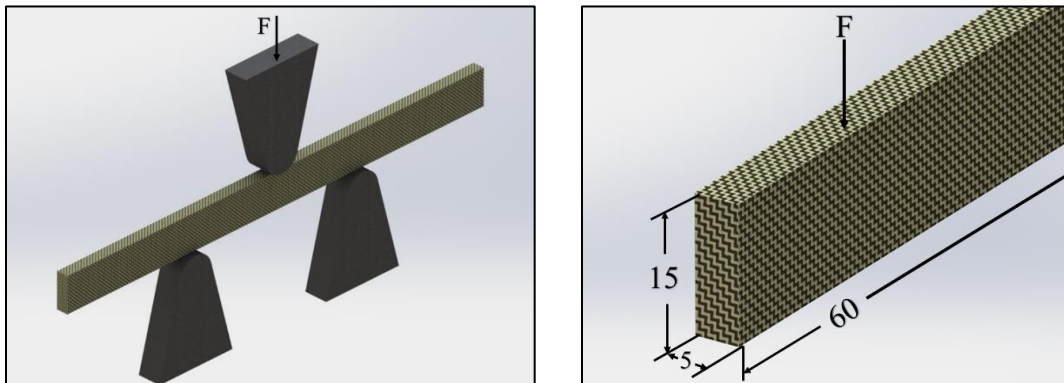

Fig. 7 Flexural test specimen according to ASTM D7264, Test mode 2, implant 90° rotation. (a) Test configuration. (b) Flexural specimen Dimensions.

As for the second mode, it is clearly evident that the moment of inertia will be different from the first due to the 90° rotation, resulting in drastically higher values of flexural stress that the test specimen can withstand.

$$\sigma = \frac{3FL}{2bh^2} = \frac{3F60}{2(5)(15)^2}$$

## RESULTS AND DISCUSSION

Figures 8 to 11, illustrates flexural force- deflection curve of four different materials that are proposed as alternative implant materials: kevlar, hybrid, carbon fibre, and flax.

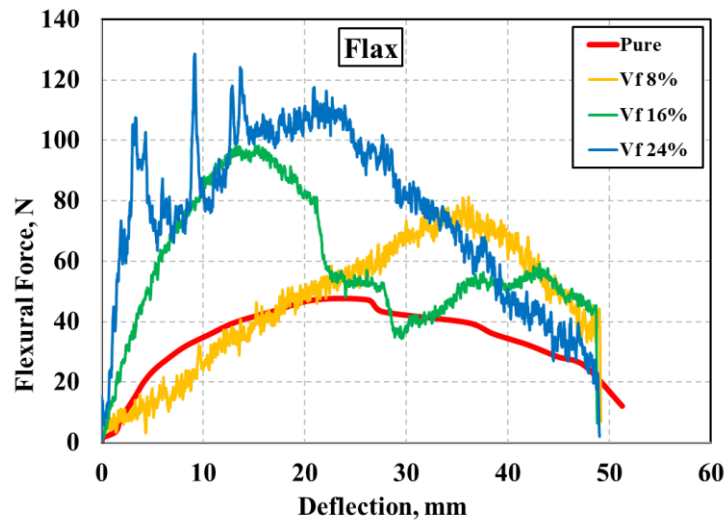

Fig. 8 Flexural force in relation to deflection for different materials curves for Flax Fibers at volume fractions 8, 16 and 24 %.

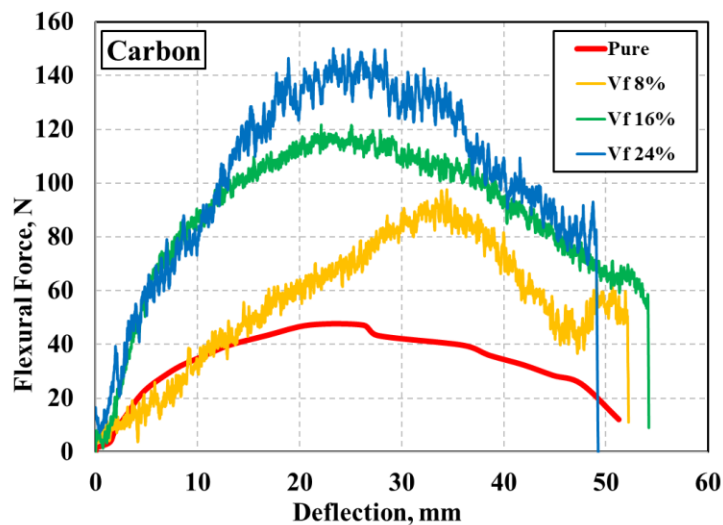

Fig. 9 Flexural force in relation to deflection for different materials curves for CF at volume fractions 8, 16 and 24 %.

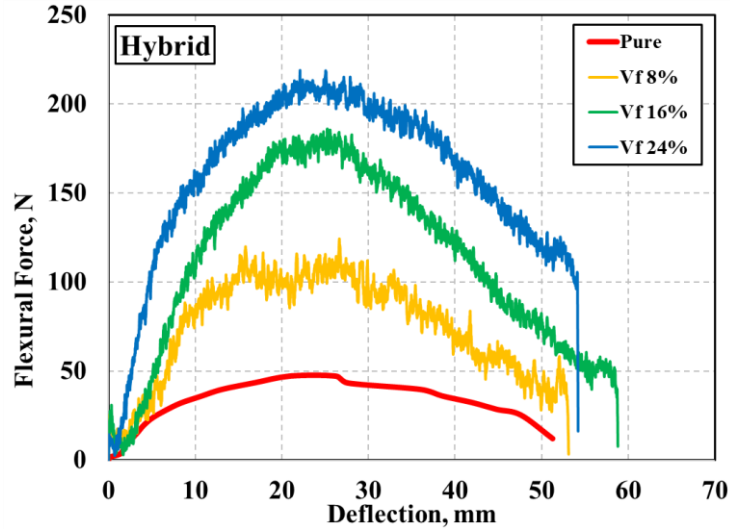

Fig. 10 Flexural force in relation to deflection for different materials curves for Hybrid Fibers at volume fractions 8, 16 and 24 %.

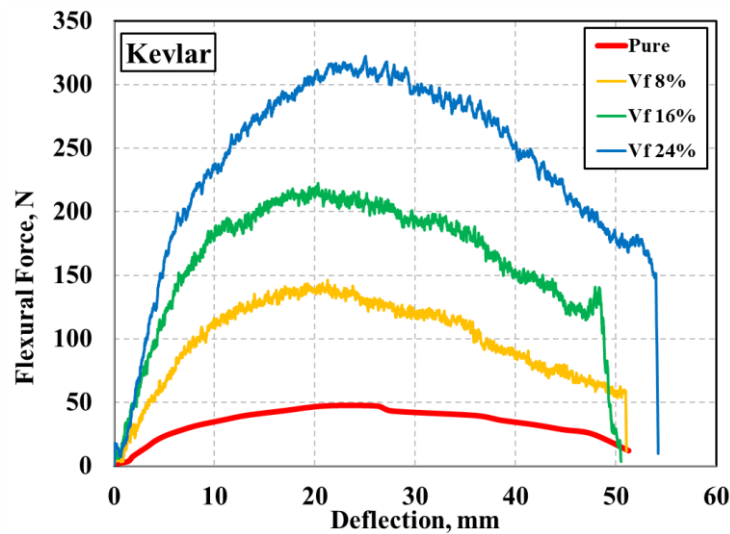

Fig. 11 Flexural force in relation to deflection for different materials curves for KF, at volume fractions 8, 16 and 24 %.

It is important to recognize that in flexural, the upper part experiences compression (above the natural axis), while the lower part undergoes tension (below the natural axis). In the first mode of bending test, the fibers in the transverse direction are more involved in responding to the bending load. Consequently, when examining the Flexural force - deflection curves, Figs. 8 - 11, they exhibit a zig-zag pattern, reflecting the continuous tearing of fibers across the transverse direction.



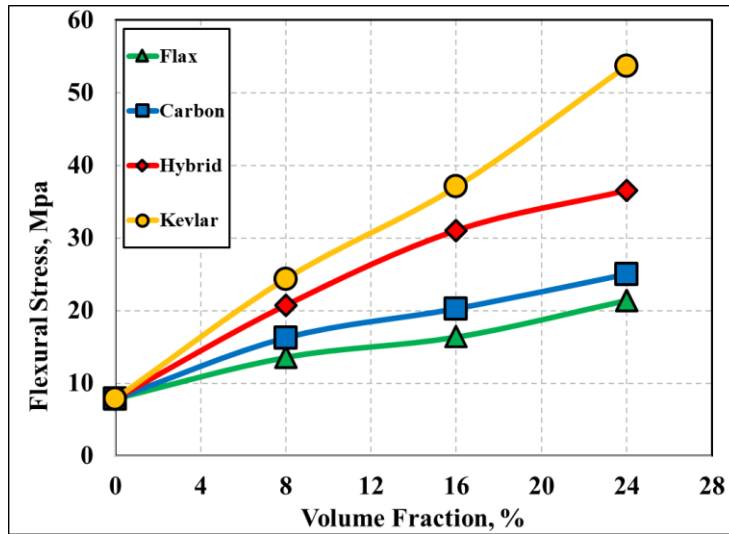

Fig. 12 Effect of volume fraction on flexural strength for KF, Hybrid, CF and Flax Fibers.

Figure 12 illustrates the effect of the volume fraction of fibers reinforcement on flexural strength. when the volume fraction increases from 8 to 24 %, all composites show a notable enhancement in flexural stress, suggesting a positive correlation between the volume fraction and the flexural stress of the proposed composites. It appears that KF consistently exhibits the highest flexural force across all volume fractions (8, 16 and 24 %), making it the most resistant to flexural bending.

The flax, CF, and hybrid fibers show ascending performance, with hybrid generally outperforming flax and CF. Moreover, regarding flexural elastic modulus, almost the same effect as mentioned above occurred, as it increased with the presence of reinforcement fibers, starting with flax, then CF, then hybrid, until arriving at the peak, which is KF fibers reaching 53 MPa at 24 % volume fraction.

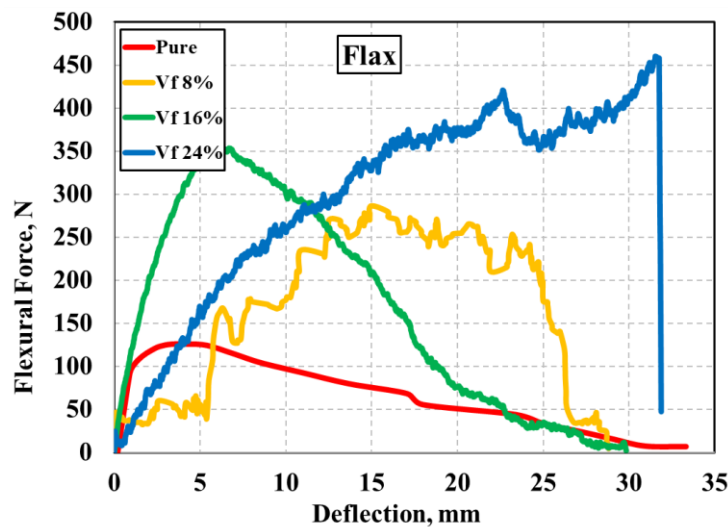

Fig. 13 Flexural force in relation to deflection for different materials curves for KF, Hybrid, CF and Flax Fibers at volume fractions 8, 16 and 24 %.

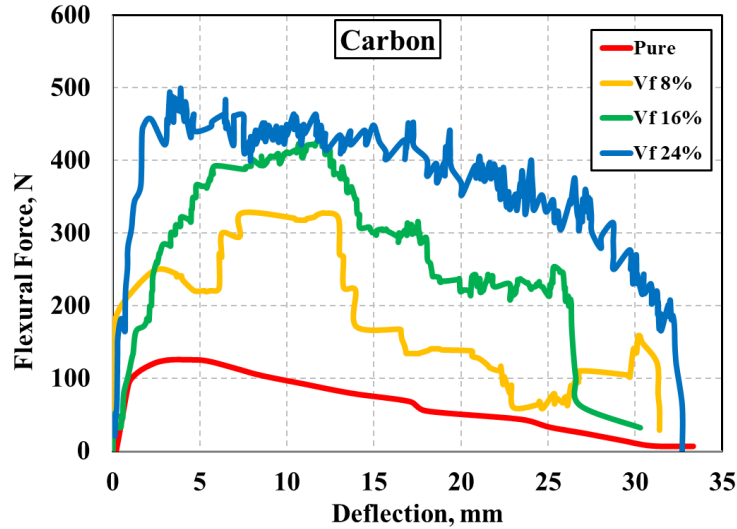

Fig. 14 Flexural force in relation to deflection for different materials curves for KF, Hybrid, CF and Flax Fibers at volume fractions 8, 16 and 24 %.

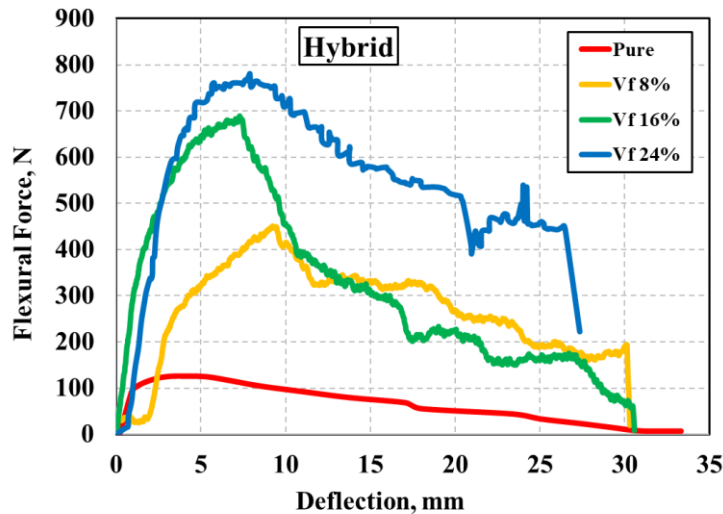

Fig. 15 Flexural force in relation to deflection for different materials curves for KF, Hybrid, CF and Flax Fibers at volume fractions 8, 16 and 24 %.

Upon initial inspection of Figs. 13 - 16, two notable observations emerge. Firstly, the fiber performance within the epoxy matrix mirrors the sequence observed in the initial bending mode. Secondly, there is a significant augmentation in flexural forces across various volume fractions. This increase aligns with predictions, stemming from the implant's 90° rotation, resulting in a heightened area moment of inertia. Consequently, the composite proposed for the implant exhibits enhanced endurance against flexural forces. However, it comes at the expense of ductility, which has dramatically retarded by about 50% compared with the first mode.

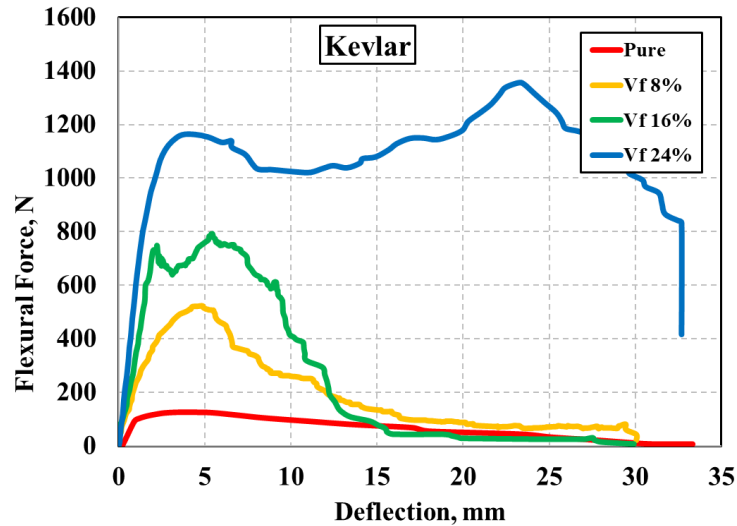

Fig. 16 Flexural force in relation to deflection for different materials curves for KF, Hybrid, CF and Flax Fibers at volume fractions 8, 16 and 24 %.

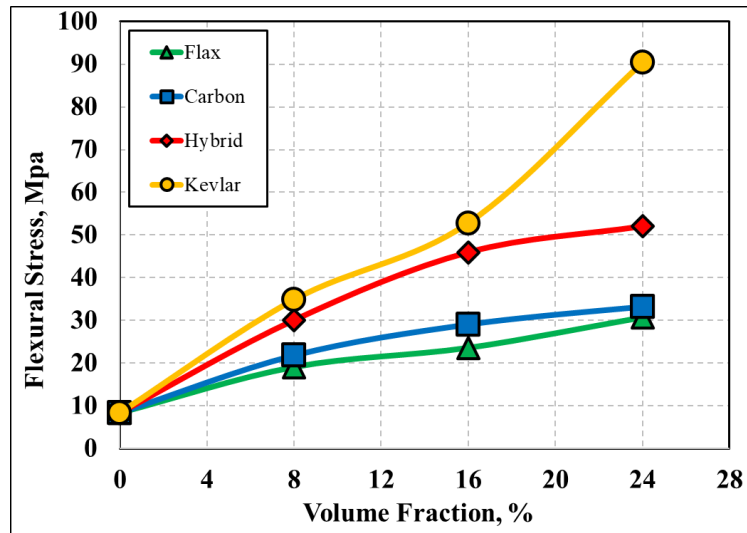

Fig. 17 Effect of volume fraction on flexural strength for KF, Hybrid, CF and Flax Fibers.

In Fig. 17, at volume fractions of 8 and 16 %, the performance of KF and hybrid fibers was relatively similar. However, a notable peak emerged for KF at a volume fraction of 24 %, reaching a value of 90.4 MPa. The evaluation of the performance composites reinforced with KF fibers through mechanical testing reveals a potentially advantageous alternative to conventional metal implants. This alternative addresses a critical concern associated with stress shielding; a phenomenon induced by the excessive toughness inherent in metal implants. The composites, characterized by reduced toughness, circumvents this issue without compromising the requisite mechanical strength essential for the effective functioning of the implant throughout the bone healing process. Consequently, the incorporation of KF in the composites emerges as a promising solution, offering a balanced compromise between toughness

and mechanical strength, thereby enhancing the overall efficacy of orthopaedic implants.

## **CONCLUSIONS**

Reinforcing epoxy with woven fibers has presented promising results that can address the issues regarding the traditional implants used. The followings are the conclusions reached:

- 1. KF outperformed in all tests conducted, exhibiting superior mechanical properties. In flexural modes, it achieved 53 MPa and 90 MPa for the first and second modes, respectively, at a volume fraction of 24 %.**
- 2. Although flax fibers have the advantage of being natural ones, that makes them more suitable for the application to be achieved, their performance in withstanding mechanical stresses was lagging compared to other types of fibers.**
- 3. As for CF and hybrid fibers, their performance was average, exceeding flax fibers and lagging KF. It is worth noting that in the case of hybrid fibers, the presence of KF with carbon increased the performance of the composites compared to the composites containing CF only.**
- 4. The flexibility of almost all composites decreased by 50 % by changing the flexural test mode from the first mode to the second mode, but this was offset by a significant increase in flexural strength.**

## **REFERENCES**

- 1. Siony N, Vuong L, Lundaajamts O, Kadkhodaei S., "Computational design of corrosion-resistant and wear-resistant titanium alloys for orthopedic implants", *Materials Today Communications*, Vol.33, pp.104465, (2022).**
- 2. Marsh M, Newman S., "Trends and developments in hip and knee arthroplasty technology", *Journal of Rehabilitation and Assistive Technologies Engineering*, Vol. 8, pp. 2055668320952043, (2021).**
- 3. Hussain M, Askari Rizvi SH, Abbas N, Sajjad U, Shad MR, Badshah MA, Malik AI., "Recent developments in coatings for orthopedic metallic implants", *Coatings*, Vol.11, No.7, pp.791, (2021).**
- 4. Suh D, Jo WL, Kim SC, Kim YS, Kwon SY, Lim YW., "Comparative analysis of titanium coating on cobalt-chrome alloy in vitro and in vivo direct metal fabrication vs. plasma spraying", *Journal of Orthopaedic Surgery and Research*, Vol.15, No.1, pp.1-7, (2020).**
- 5. Kurmis AP, Ianunzio JR., "Artificial intelligence in orthopedic surgery: evolution, current state and future directions", *Arthroplasty*, Vol. 4, No. 1, pp.1 - 10, (2022).**
- 6. Soares dos Santos MP, Bernardo RM., "Bioelectronic multifunctional bone implants: recent trends", *Bioelectronic medicine*, Vol. 8, No. 1, pp. 15, (2022).**
- 7. Clunk MJ, Gonzalez MR, Denwood HM, Werenski JO, Sodhi A, Hoffman BA, et al., "A PEEK into carbon fiber: A practical guide for high performance composite polymeric implants for orthopaedic oncology", *Journal of Orthopaedics*, Vol. 45, pp. 13 - 18, (2023).**
- 8. Zheng Z., Liu P., Zhang X., Zou X., Mei X., Zhang S., Zhang S., "Strategies to improve bioactive and antibacterial properties of polyetheretherketone (PEEK) for use as orthopedic implants", *Materials Today Bio*, Vol.16, pp.100402, (2022).**

9. Chen Z., Chen Y., Ding J., Yu L., "Blending strategy to modify PEEK-based orthopedic implants", *Composites Part B: Engineering*, Vol. 250, pp. 110427, (2023).
10. Eyad N., Ali W., Nabhan A., "Mechanical Properties of cervical Fusion plates fabricated from Polyethylene reinforced by Kevlar and Carbon Fibers", Vol. 74, No. 6, pp. 42 - 47, (2021).
11. Eyad M., Ali W., Nabhan A., "Wear Behavior of Cervical Fusion Plates Fabricated from Polyethylene Reinforced by Kevlar and Carbon Fibers", *EGTRIB J*, Vol.18, No.1, pp. 8 - 17, (2021).
12. Karthik K., Rajamani D., Manimaran A., Udayaprakash J., "Evaluation of tensile properties on Glass/Carbon/Kevlar fiber reinforced hybrid composites", *Materials Today: Proceedings*, Vol. 39, pp. 1655 - 1660, (2021).
13. Rajak D. K., Pagar D. D., Menezes P. L., Linul E., "Fiber-Reinforced Polymer Composites: Manufacturing, Properties, and Applications", *Polymers*, Vol. 11, No. 10, pp. 1667, (2019).
14. Rajak D. K., Wagh P. H., Linul E., "A Review on Synthetic Fibers for Polymer Matrix Composites: Performance, Failure Modes and Applications", *Materials*, Vol. 15, No. 14, pp. 4790, (2022).
15. Rout S., Nayak R. K., Patnaik S. C., Yazdani N. H., "Development of improved flexural and impact performance of kevlar/carbon/glass fibers reinforced polymer hybrid composites", *Journal of Composites Science*, Vol. 6, No. 9, pp. 245, (2022).
16. Mavinkere R. S., Siengchin S., Jawaid M., "Mechanical and thermal properties of flax/carbon/kevlar based epoxy hybrid composites", *Polymer Composites*, Vol. 43, No. 8, pp. 5649 - 5662, (2022).
17. Yeung C. M., Bhashyam A. R., Patel S. S., Ortiz-Cruz E., Lozano-Calderón S. A., "Carbon Fiber Implants in Orthopaedic Oncology", *Journal of Clinical Medicine*, Vol. 11, No. 17, pp. 4959, (2022).
18. Kangishwar S., Radhika N., Sheik A. A., Chavali A., Hariharan S., "A comprehensive review on polymer matrix composites: Material selection, fabrication, and application", *Polymer Bulletin*, Vol. 80, No. 1, pp. 47 - 87, (2023).
19. AL-Rabab'ah M., Hamadneh W., Alsalem I., Khraisat A., Abu Karaky A., "Use of high performance polymers as dental implant abutments and frameworks: a case series report", *Journal of Prosthodontics*, Vol. 28, No. 4, pp. 365 - 372, (2019).
20. Rendas P., Figueiredo L., Machado C., Mourão A., Vidal C., Soares B., "Mechanical performance and bioactivation of 3D-printed PEEK for high-performance implant manufacture: a review", *Progress in biomaterials*, Vol. 12, No. 2, pp. 89 - 111, (2023).
21. Lin A. S., Fechter C. M., Magill M., Wipf F., Moore T., Guldberg R. E., "The effect of contouring on fatigue resistance of three types of fracture fixation plates", *Journal of orthopaedic surgery and research*, Vol. 11, pp. 1 - 7, (2016).
22. Zaokari Y, Persaud A, Ibrahim A., "Biomaterials for adhesion in orthopedic applications: a review", *Engineered Regeneration*, Vol.1, pp. 51 - 63, (2020).
23. Rudawska A., Sarna-Boś K., Rudawska A., Olewnik-Kruszkowska E., Frigione M., "Biological Effects and Toxicity of Compounds Based on Cured Epoxy Resins", *Polymers*, Vol. 14, No. 22, pp. 4915, (2022).
24. Campanale C., Massarelli C., Savino I., Locaputo V., Uricchio V. F., "A Detailed Review Study on Potential Effects of Microplastics and Additives of Concern on

**Human Health", International Journal of Environmental Research and Public Health, Vol.17, No. 4, pp. 1212, (2020).**

**25. Heiss C, Kraus R, Schluckebier D, Stiller A-C, Wenisch S, Schnettler R., "Bone adhesives in trauma and orthopedic surgery", European Journal of Trauma, Vol.32, pp.141-148, (2006).**

**26. Krishnakumar S, Senthilvelan T., "Polymer composites in dentistry and orthopedic applications-a review", Materials Today: Proceedings, Vol. 46, pp. 9707-9713, (2021).**

**27. Aisyah H. A., Paridah M. T., Sapuan S. M., Ilyas R. A., Khalina A., Nurazzi N. M., et al., "A Comprehensive Review on Advanced Sustainable Woven Natural Fibre Polymer Composites", Polymers, Vol.13, No.3, pp.471, (2021).**

**28. Li C. S., Vannabouathong C., Sprague S., Bhandari M., "The use of carbon-fiber-reinforced (CFR) PEEK material in orthopedic implants: a systematic review", Clinical Medicine Insights: Arthritis and Musculoskeletal Disorders, Vol.8, pp. 33 - 45, (2015).**