

Manufacture a New Milling Machine to Produce Bio Fuel from Olive Milling Wastes

Kaddour, O.¹ and M. I. El Didamony²

¹Dept., Fac. of Fish Resources Suez Univ., Egypt

²Dept. of Agric. Eng., Tanta Univ., Egypt.



ABSTRACT

Field experiments were carried out to manufacture a new milling machine produce biofuel from olive mill wastes (OMW). The machine was performance under laboratory and filed conditions such as the effect of milling parameters on milling efficiency and bio fuel pellets quality. The machine performance was conducted under four different hammer mill drum speed of (5.25, 6.46, 8.59 and 10.41 m/s.), crumble drum speed of (4.46, 5.93and 7.19 m/s.) crumble drums clearance (1.5 and 2.5mm) and olive pomace wastes percentage of (olive pomace 100% and olive pomace 50% with olive stone 50 %.). The machine performance was evaluated in terms of machine production rate, specific energy (SE), machine efficiency, olive milled granules 3mm diameter or less percentage, biofuel pellets durability and biofuel pellets stability during combustion. The best results were 0.368 Mg/h for machine production rate, 4.33 kW.h/Mg for specific energy (SE), 46.20% the percentage of granules3mm diameter or less as optimum milled particle size suitable for pelleting, 70.58% bio fuel pellets durability and 83% pellets Stability during combustion after one hour, using 8.59 m/s hammer mill drum speed, 5.93 m/s crumble drum speed, 1.5mm clearance between crumble drums, and recommended use 50% olive pomace with 50% olive stones

Keywords: milling machine, hammer mill, crumble, olive wastes, Biofuel, olive pomace, fuel pellets, specific energy , pellets durability and milling efficiency

INTRODUCTION

There are more than 750 million olive trees cultivated all over the world, 95% of them in the Mediterranean. The most global production comes from southern Europe, the Maghreb and the Levant, Spain alone has more than 215 million trees on an area of 2 million hectares, and equivalent to 27% of the world's cultivated area .World olive production was 2.6 million metric tons in 2002, of which Spain contributed 40% to 45%, followed by Tunisia by 7%. Turkey in 2006 produced about 5 % of world production. Estimated cultivated areas of olive trees in Egypt in the old and new lands 227683 Fed. and fertile areas 165903 Fed produces approximately698927 tons of olives (Economic Affairs Sector statistics - Ministry of Agriculture, 2017). A lot of amount of olive plant residues of oil extract and pickling processing is a real problem for factories such as they seal it by very low price in addition to its affect the health and environment requirements as consequence of extraction processes, which naturally affect the quality of production Olive oil extraction factories wastes including olive pomace, olive seeds after milling, fruits peel and fruits fiber , it generally contains 2-7% oil and accounts for 45-65% of the fruit production rate. After the expression of the oil from olive fruits, there are two kind of residues the press-cake and waste water .Olive oil extraction is an ancient agricultural industry all over the Mediterranean area, it is very economic importance for many countries. This agro-industrial activity generates large amounts of waste that is usually un used and in most cases poses a completely harm to the environment (Karapmar and Worgan ,1983). Olive mill waste waters (OMWW) at any olive oil industry have high organic content, solid matter and phenolic compounds. Most of the studies OMWW sludge focus on composting application.

More recent approach to utilizing OMW has involved using processing technologies to fractionate high-value components from olive residues. Future olive oil industries should be utilizing olive waste

OMW, for producing valuable by products. (Athanasia and Goula, 2017). (Haddadin, *et al.*, 1999)Said that olive pomace same of many agricultural residues, is not often use as animal feed, in that it contains, on a dry matter basis, fiber (58.0%), crude protein (5.5%) lipids (3.5%), soluble carbohydrates (20.0 %) and ash (13.0%) In particular, the low protein and energy values make it impossible to use dried pomace directly. There is significant increased the level of crude protein from 5.9% in the raw pomace to 40.3% in the fermented material after treatment. Olive cultivation and olive oil production become more popular in many countries, so that lead to increase olive wastes. Olive oil by-products are produced from too much amounts than olive oil it around four times larger than the olive oil produced. Thus, the utilization of olive oil by-products could help solve these environmental problems and create a new agricultural demand. (Ghanbari *et al.*, 2012)Olive pomace is usually content percentage of oil and some industries treated the olive pomace to extract it and the remove the olive crushed stones. Olive stones represent 10-15% of the olive total weight which are used as a bio fuel. The olive pomace including a moisture content of 10% meanwhile waste water is produced during olive cleaning.

All this amount of biomasses need practical application to produce by-products or residues recycling. Olive stones are very appropriate for thermal bio fuel application use because it content (22.5%) lignin, and has high heating value of 19.7 MJ/kg. A study indicated that the temperature from 200 to 900 C° identified 278°C as the optimal temperature of the olive stones, resulting an increased higher heating value of 23.4 MJ/kg, whereas the carbonization process between 500 to 900 C° improved values of the lower heating value of energy and density better than original biomasses (Paloma and Maria, 2017).

The main production of olive pomace is oil, which is extracted from olive pomace in industries, the olive pomace after extract used as a bio fuel to produce electrical energy, pomace ashes have a high content of

phosphor and potassium and can be used as composting (Jose *et al.*, 2006). Recycling olive wastes after extraction the oil, to be used as raw material for many applications requires special grinding system to make it as a powder and this is difficult to implement by hammer mill grinding machines because olive plant wastes consist of a proportion of oils and fats up to 5% which lead to blocking the sieve openings holes in hammer mill types. There are many types of olive crushers used to preparing process of oil extract, the studies comparing between tow kind of hammer mill used to mill the olive stones, hammer crushers with disk crushers and hammer crushers with blade crushers (Veillet, *et al* 2009). The hammer crusher is the most widely useful kind of milling machine in all olive industries for high productivity and stability performance. The effect of hammer crusher drum speed and screen holes size on olive stones production and efficiency were studied. Both parameters indicated high affect for the specific energy and final product size distributors and fines (Juan *et al*, 2018).

The aim of this research that manufacture and evaluation a simple mechanical and economic machine able to mill the olive wastes after oil extraction process can produce olive mill waste (OMW) by new techniques to solve all the problems facing this process by using hammer mill machine, such as the screen holes blocking and high percentage of large particles in final product

The raw material after the milling operations will be compressed through a flat die pellet mill to produce the bio fuel as green thermal heating application for houses and poultry farms as well as source of energy in brick and cement factories and many other applications to save the production costs after the steady rise in fuel prices.

MATERIALS AND METHODS

The experiments were carried out at one of the factories producing olive oil and pickled in 10th of Ramadan City in 2019. The factory very famous in Egypt and export them product for 56 countries, they have allotted of olive industrial residues every month and that affect the quality and environmental safety standards of the factory.

Material:

The olive milled waste (OMW) compassion and chemical analysis

This research focus about one kind of olive fruits, *Olea europaea L.* it is the most consumed kind use in both processing oil extract and pickling. The raw material used to produce the biofuel were two principal kind of residues in the factory, olive pomace and olive stone (olive seeds), the experimental were carried out tow formulas has different percentage of both factory residues used for milling process as following: A- Olive pomace (100%) has chemical analysis of 10.7% moisture content (DM), 36.08% fiber, 8.5% protein, 6.74 fats and 4% ash , B- Olive pomace (50%) with olive stone (50%) has chemical analysis of 8.9%

moisture content (DM), 53.20% fiber, 1.9% protein, 4.75% fats and 1.5%.

The olive waste milling machine specifications:

A local milling machine show in Fig. (1) Consists of machine base, milling system, transmission system. It was manufactured and evaluated to use for olive waste OMW through a special system based on two theories of grinding through a special system based on two theories of grinding in two stages, first stage is hammer mill machine and second stage is drum milling machine, as illustrated in Fig.(2)

Machine base:

The machine base made from L shape steel bar 22mm the base dimension was 360×700 mm connected with steel pallet 150mm thickness and the base has 4 legs highest of 440 mm.

Milling system:

The olive milling system including feeding hopper has dimension of 400×400 mm has conic shape bottom, the open gate of the hammer mill diameter of 250mm, the milling system consists of two stages first stage the hammer mill stage drum has diameter of 250mm and 20 mm thickness ,its connecting by 2 bars each bar has 10 hammers .

No.	Name of part
1	Machine base
2	Hammer mill stage
3	Crumble drums stage
4	Gasoline engine
5	Hammer mill drum pulley
6	Crumble drum pulley

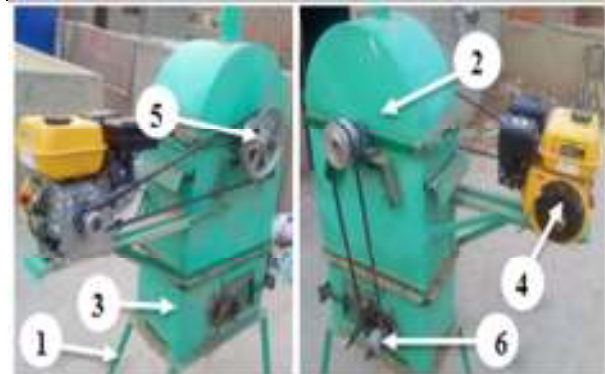

Fig. 1. Profile of the olive milling machine.

The hammers dimension were 180×40×5 mm, the hammer mill drum shaft has diameter of 80 mm ,the hammer mill stage has screen holder to change the screen size easily, the screen holes diameter were 5mm.The second milling stage were drum milling machine, at this stage, the large granules as the milling products from the first stage milled to the smaller granules though crumble drums, the crumble has 120mm diameter and 240 mm length each. Both cylinders are serrated diagonally, the width of the tooth is 5 mm and a depth of 5 mm. The power transmitted from the hammer mill drum shaft to one of the cylinders by tow pulleys to increase the drum velocity by diameter ratio 2: 1 there are clearance key to control the distance between both crumble drums.

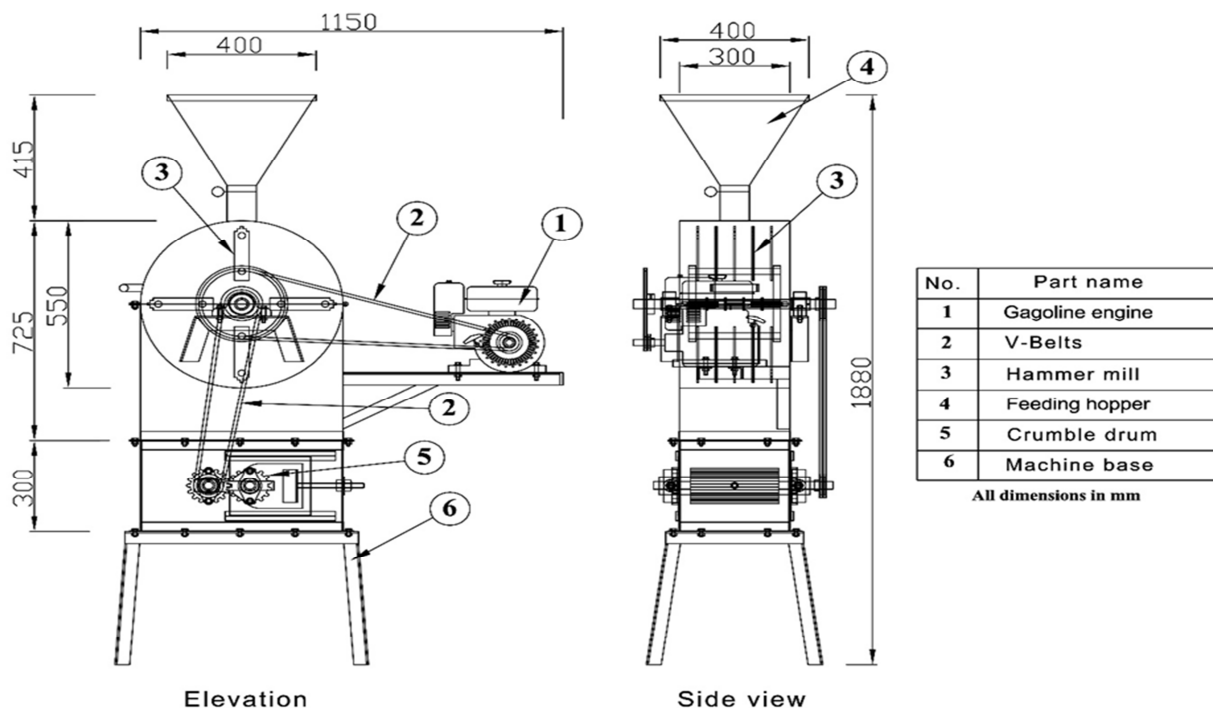

Fig. 2. Elevation and side view of the manufactured milling machine

Transmission system:

The power was transmitted from the gasoline engine has output shaft maximum speed and power of 3600 rpm and 7.35kW respectively. As illustrated in Fig. (3)

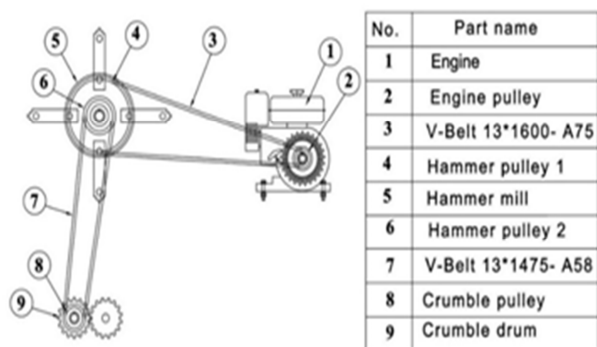

Fig. 3. The transmission system of the milling machine system

The engine shaft pulley diameter were 54mm, connecting by hammer mill drum shaft pulley has diameter of 235mm by V- belt size of 13*1600-A75, on the same hammer mill drum shaft there is another pulley has diameter of 115mm to transferee the power from milling drum pulley to crumble drum pulley it has diameter of 80 mm,

Methods:

Experiment's conditions

The experiments were carried out to evaluated the efficiency and performance of the developed olive milling machine by study the effect of the percentage of olive pomace and olive stone as raw material and the effect of milling mechanical parameters on milling efficiency and bio mass pellets quality, the parameters under study were :

- 1- Hammer mill drum speed of (5.25, 6.46, 8.59 and 10.41m/s.)
- 2- Crumble drum speed of (4.46, 5.93and 7.19 m/s.)

- 3- Crumble drums clearance (1.5 and 2.5mm)
- 4- Olive wastes percentage of (Olive pomace 100% and Olive pomace 50% with olive stone 50 %.)

Measurements

Rotating speed measuring device leaser tachometer made in china

Local durability turning box 3 cells, rotating speed of 70 rpm for 10 min

Stop watch Casio FX53

Weighting scales maximum weight (1 kg).with accuracy of 10g, ±1 g

Weighting scale maximum weight (10 kg).with accuracy of 50g, ±5 g

Mechanical shaker sieves made in USA

Evaluation of olive milled quality and machine performance

Machine production rate

it was measured for each treatment by taking sample for 2 min after 15 min. of machine running.

Power consumption and specific energy (SE)

Volumetric fuel consumption was determined by measuring the volume of the consumed fuel during the experiment time. It was calculated as the following:

$$VFC = V/t \dots\dots\dots (1)$$

Where VFC is the volumetric fuel consumption rate, lh⁻¹; V is the volume of consumed fuel, l and t is the duration of the experiment, h.

The following formula was used to estimate Power (P) as provided by Hunt (1983)

$$P = (FC/c) \times (\eta^{th}/100) \times HV \dots\dots\dots(2)$$

$$Energy\ requirement = \frac{P}{Q} = kW\ h / Mg \dots\dots(3)$$

Where: P is required power, kW; FC is fuel consumption, kgh⁻¹; ηth is the thermal efficiency, %; HV is the fuel heating value, kJkg⁻¹; and c is a constant, 3600, Q = Machinery line productivity, Mg/h.

Olive waste milling machine efficiency

$$Efficiency = \frac{M_o}{M_i} \times 100 \dots \dots (4)$$

Where: M_i , The input mass 10 kg (gm) and M_o , the milled output mass (gm)

Milled waste particle size diameter of 3 mm or less percentage

Pellets bio mass pellets marketing diameter usual between 6mm to 10mm as EURO exporting requirement, to increase the bio fuel pellets quality such as durability and bulk density should the milling granules consists of high percentage of granules has diameter 3mm or less so we get 1 kg sample from each treatment and measured the percentage of granules 3mm or less diameter using the mechanical shaker has 3.2mm holes diameter stainless steel sieve.

$$Particle \% = \frac{M_b}{M_a} \times 100 \dots \dots (5)$$

Where: M_b and M_a , The mass before and after the shaker treatment (gm.)

Bio mass pellets durability

Bio mass Pellets durability was determined using durability turning box at 70 rpm for 10 min. (AACC, 2000.)

$$Durability, (\%) = \frac{W_a}{W_b} \times 100 \dots \dots (6)$$

Where: W_a : Pellets mass after treatment, g and W_b : Pellets mass before treatment, g

Olive milled waste (OMW) biofuel pellets Stability during combustion

It was calculated by put the pellet in burning bottle and measure the number of pellets still stable in fire every 15 min from start, to 150 min.

$$Pellet\ fire\ stability = \frac{N_{stl}}{N_t} \times 100 \dots \dots (7)$$

Where N_{stl} : Number of stable pellets in the fire and N_t : Total number of pellets

RESULTS AND DISCUSSION

Olive milled machine production rate:

Olive mill waste (OMW) production rate one of the machine performance measurements, many parameters affecting the production performance such as the drum speed in both stages, clearance between crumble drums and the percentage of olive seeds in wastes.

Results in Fig. (3) showed that increasing hammer mill drum speed from 5.25 to 8.59 m/s increased production rate as average by 18.37 and 15.15% .Meanwhile increase the hammer mill drum speed up to 10.41m/s decreased the machine production as average by 4.04 and 4.20% at crumble drum clearance of 1.5 and 2.5 respectively, under all crumble drum speed and olive pomace percentage. The increase in production rate by increasing hammer mill drum speed from 5.25 to 8.59 m/s could be due to the decrease in treatment time consumed that lead to increase the machine output mass.

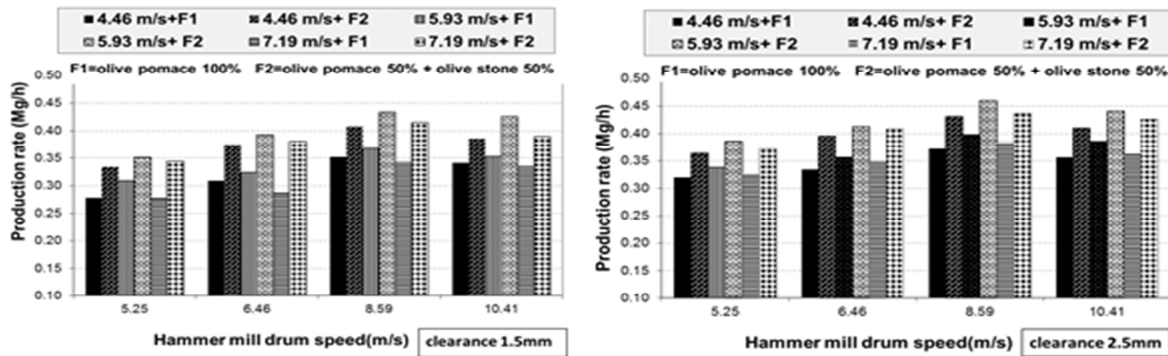

Fig. 3. Effect of hammer mill drum speed on machine production rate at different crumble drum speeds, different pomace percentages and different crumble clearances.

Meanwhile The decrease in machine production rate by increasing the hammer mill drum speed up to 10.41 m/s that could be due to the hammer mill drum high speed generate centrifugal force cause to the granules rotate inside the hammer mill stage case so reduce the material flow through the hammer mill sieve holes, that lead to reduce the machine production rate.

Same figure showed the indicate of crumble drums speed, data showed increase the crumble drum speed from 4.46 to 5.93 m/s increased the machine production as average by 5.95 and 6.17% but when we increase the crumble drum speed to 7.19m/s the production decreased by 6.83 and 3.62% at crumble drum clearance of 1.5 and 2.5 respectively, under all hammer mill drum speeds and different olive pomace percentage in waste raw material. The increase in production rate by increase crumble drum speed from 4.46 to 5.93 m/s could be due to at this speed the drum teeth can catch the crushed olive waste under the

hammer mill sieve and milled between the 2 drums in short time that increase the mass product in time unit , but increasing the crumble drum up to 7.19m/s decreased the machine production cause the high crumble speed lead to make the crushed waste collisions with the crumbles drum teeth and moving around them without passing between drums and that reduce the mass in time unit.

Data showed too change the percentage of pomace in treatment waste to become 50% olive pomace with 50% olive stones increased the machine production as average by 54.47 and 52.11% at crumble drum clearance of 1.5 and 2.5 respectively, under all hammer mill drum speeds and crumble drum speeds .this clear and high increasing in machine production rate could be due to the decrease in olive waste viscosity by add the olive stone and reduce the oil percentage in raw material so makes the raw material difficult to be create a fat film up of crumble drum teeth and reduce the machine output.

Regarding to the effect of crumble drum clearance on machine production rate, Fig(3) showed increasing the clearance between the both drums from 1.5 mm to 2.5 mm increase the machine production as average by 7.78% under all hammer mill drum speeds , crumble drum speed and different olive pomace percentage in waste raw material. The increase in machine production by increasing the crumble drums clearance up to 2.5 mm could be due to the increase in distance between drums make the large size granules pass between drums fast without crumbling so that reduce the treatment time and increase the mass in time unit.

Olive milling machine specific energy (SE):

After the rise in the prices of the electric power unit for industrial activities, the goal of any industrial institution to reduce the energy consumed of mass product unit.

Data in Fig (4) showed that increasing hammer mill drum speed from 5.25 to 8.59 m/s decreased the specific energy as average by 9.94 and 2.59% .Meanwhile increase the hammer mill drum speed up to 10.41m/s increased the specific energy as average by 14.85 and 15.57% at crumble drum clearance of 1.5 and 2.5 respectively, under all crumble drum speed and olive pomace percentage. The decrease in specific energy by increasing the hammer mill drum speed from 5.25 to 8.59 m/s could be due to the high increase in machine production with little increase in machine power consumed .However The increase in specific energy by increasing the hammer mill drum speed up to 10.41 m/s that could be due to more increase in machine power consumed with a decrease in machine production rate.

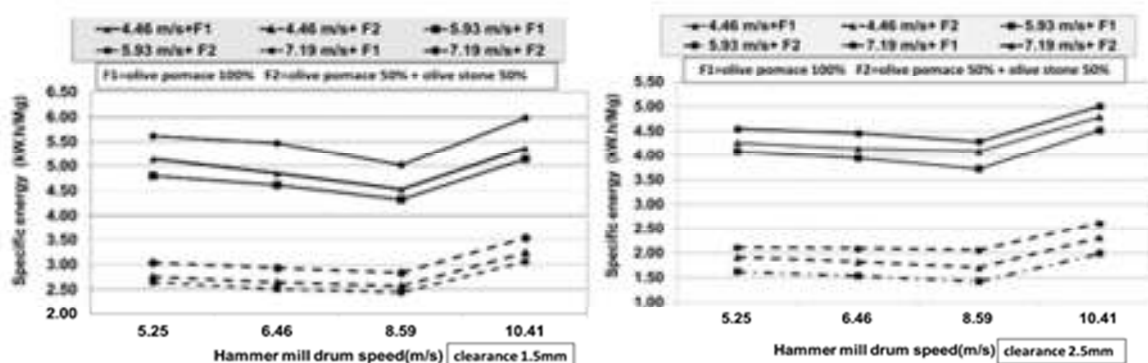

Fig. 4. Effect of hammer mill drum speed on specific energy (SE) at different crumble drum speeds, different pomace percentages and different crumble clearances.

Regarding to the effect of crumble drum speed on machine specific energy, data showed increase the crumble drum speed from 4.46 to 5.93 m/s decreased the machine specific energy as average by 2.15 and 1.14 % but when we increase the crumble drum speed to 7.19m/s the specific energy increased by 27.13 and 11.91% at crumble drum clearance of 1.5 and 2.5 respectively, under all hammer mill drum speeds and different olive pomace percentage in waste raw material. The decrease in specific energy by increase crumble drum speed from 4.46 to 5.93 m/s could be due to the increase in machine production with little increase in power consumed, but increasing the crumble drum up to 7.19m/s increased the machine specific energy cause the high increase in power consumed by the more load of crumble drums with sharp decrease in machine production.

On other hand same figure showed change the percentage of pomace in treatment waste to become 50% olive pomace with 50% olive stones decreased the machine specific energy as average by 75.84 and 110.11% at crumble drum clearance of 1.5 and 2.5 respectively, under all hammer mill drum speeds and crumble drum speeds. The decrease in specific energy by change the olive waste formulation from 100% pomace to 50% olive pomace with 50% could be due to the increase in machine production with decrease in power consumed by decrease of machine load in crumble stage.

Meanwhile, data showed too increase the crumble drum clearance from 1.5 to 2.5 mm decreased the specific energy as average sharply by 23.16% under all hammer mill drum speeds, crumble drum speed and different olive

pomace percentage in waste raw material. The decrease in machine specific energy by increasing the crumble drums clearance up to 2.5 mm could be due to the increase in distance between drums mean increase the production output and reduce the machine load with high decrease in power consumed.

Olive milled (3mm or less) particle size percentage

It is common knowledge in any pelleting process that the raw material particle size affect the pelleting efficiency and product quality, milling the raw material to low particle size increase the bulk density, increase the moisture absorption through the pelleting process, reduce the losses, reduce the wearing of mechanical parts by friction, decrease the SE, and increase the pellets durability. The size reduction of any raw material as preparation for pelleting process should be between 2-3 mm produce best qualities of pellets

Data in Fig. (5) indicated that increasing hammer mill drum speed from 5.25 to 8.59 m/s increased the 3mm particle size percentage as average by 24.76 and 35.84% .Meanwhile increase the hammer mill drum speed up to 10.41m/s decreased the 3mm particle size percentage as average by 7.32 and 8.82% at crumble drum clearance of 1.5 and 2.5 respectively, under all crumble drum speed and olive pomace percentage. The increase in 3mm particle size percentage by increasing hammer mill drum speed from 5.25 to 8.59 m/s could be due to the residues are exposed to a greater number of shocks between the hammers and milling concave in the time unite, which increases the size reduction and increase the fine granules percentage.

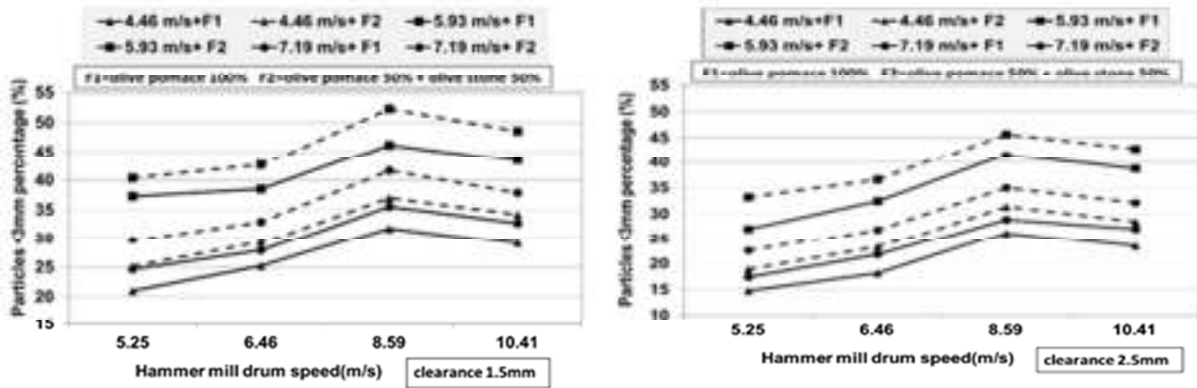

Fig. 5. Effect of hammer mill drum speed on olive milled particle size percentage less than 3mm at different crumble drum speeds, different pomace percentages and different crumble clearances.

Data in same figure reported that increase the crumble drum speed from 4.46 to 5.93 m/s increased the 3mm particle size percentage as average by 33.57 and 37.46% but when we increase the crumble drum speed to 7.19m/s the 3mm particle size percentage decreased by 31.17 and 40.03% at crumble drum clearance of 1.5 and 2.5 respectively, under all hammer mill drum speeds and different olive pomace percentage in waste raw material. The increase in 3mm particle size percentage by increasing the crumble drum speed from 4.46 to 5.93 m/s could be due to the increase of fraction between the olive wastes and drum teeth with drum incision that lead to increase the percentage of fine granules less than 3 mm. Nevertheless, the decrease in the 3mm particle size percentage by increase the crumble drum speed to 7.19m/s could be due to the change in kinematic coefficient between the hammer mill drum speed and crumble drum speed, as we know there are Inverse relationship between the force and velocity at constant power consumed, so increase the drum velocity up of the limit, clear we can see a reduce in crumble force and reduce of the 3mm particle size percentage.

Regarding to the effect of waste formula, Data indicated that, change the percentage of pomace in waste treatment to become 50% olive pomace with 50% olive stones increased the 3mm particle size percentage as average by 35.67 and 16.20% at crumble drum clearance of 1.5 and 2.5 respectively, under all hammer mill drum speeds and crumble drum speeds. The increase in 3mm particle size percentage could be due too that add 50% of olive stone to the pomace reduce the waste viscosity and that increase the milling efficiency.

Data in Fig(5) showed too increase the crumble drum clearance from 1.5 to 2.5 mm decreased the 3mm particle size percentage as average by 21.49% under all hammer mill drum speeds, crumble drum speed and different olive pomace percentage in waste raw material. The decrease in 3mm particle size percentage by increasing the crumble drums clearance up to 2.5 mm could be due to using 2.5 mm clearance create a gap between both crumble drums allowed the granules to pass the crumble drums.

Olive waste pellets durability:

Pellets durability one of most important measurement that affecting pellets quality it's determines the extent resistance of pellets through the handling process. Results in Fig.(6) showed that increasing hammer mill drum speed from 5.25 to 8.59 m/s increased the pellets durability by 18.89 and 21.17% Meanwhile increase the hammer mill drum speed up to 10.41m/s decreased the pellets durability as average by 5.77 and 4.14% at crumble drum clearance of 1.5 and 2.5 respectively, under all crumble drum speed and olive pomace percentage. The increase in pellets durability by increasing hammer mill drum speed from 5.25 to 8.59 m/s could be due to the increase in pellets compression ratio by the increase in pellets density cause the very fine particles size of (OMW).By the way the decrease in pellets durability by increase the hammer mill drum speed up to 10.41m/s could be due to the high drum speed generate a centrifugal force it take the fine granules move around the drum and the heavy granules fill down by gravity through the screen then the pellets has large granules it causes high percentage of broken and crack pellets so reduce the pellets durability.

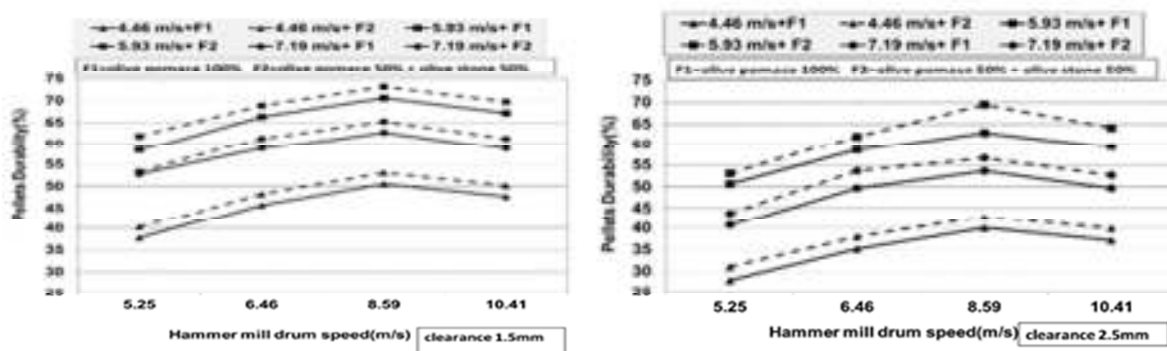

Fig. 6. Effect of hammer mill drum speed on olive biofuel pellets durability at different crumble drum speeds, different pomace percentages and different crumble clearances.

Referring to the effect of crumble drum speed on machine pellets durability, data showed increase the crumble drum speed from 4.46 to 5.93 increased the bio fuel pellets durability as average by 30.33 and 37.91% but when we increase the crumble drum speed to 7.19m/s the pellets durability decreased by 13.02 and 19.46% at crumble drum clearance of 1.5 and 2.5 respectively, under all hammer mill drum speeds and different olive pomace percentage in waste raw material. The increase bio fuel pellets durability by increasing the crumble drum speed from 4.46 to 5.93m/s could be due to the increase in waste size reduction by crumble drums that lead to increase the fine particle size percentage and pellets bulk density so increase the bio fuel pellets durability. But the light decrease in bio fuel pellets durability by increasing crumble drum speed up to 7.19m/s could be due to at this speed the some large granules flow through the groves between the drum teeth by fast speed and that cause crake in pellets and lead to collapse the bio fuel pellets after durability test.

Data in Fig (6) showed that too change the percentage of pomace in waste treatment to become 50% olive pomace with 50% olive stones affecting the bio mass pellets durability it increased the pellets durability as average by 4.26 and 1.81% at crumble drum clearance of 1.5 and 2.5 respectively, under all hammer mill drum speeds and crumble drum speeds. The increase in pellets durability by change the percentage of pomace in waste treatment could be due to the percentage of olive stones has low percentage of oil than the pomace that lead to increase the fine particles

percentage and that increase the extent resistance of pellets for the handling.

Regarding to the effect of increase the crumble drum clearance from 1.5 to 2.5 mm, it decreased the pellets durability percentage as average by 19.46% under all hammer mill drum speeds, crumble drum speed and different olive pomace percentage in waste raw material that cause the increasing of clearances lead to increase the raw material particle size and decrease the crake pellets percentage.

Olive milled waste (OMW) bio fuel pellets stability during combustion:

From previous data, we can select the best parameters that give us balanced results of machine production rate, specific energy (SE), percentage of delicate milled olive wastes particle less than 3mm, and bio fuel olive waste pellets durability and then test these treatments pellets for pellets Stability during combustion using both king of raw material (100% olive pomace waste and 50% olive pomace waste with 50% olive stone waste).Data showed in Fig (7) indicated that bio fuel pellets made from100%olive pomace waste raw material more stable than the one made from50% olive pomace waste with 50%olive stone waste raw material, the percentage of stable pellets in combustion were, 100, 100, 97, 92 , 63, 32, 27, 9, 3,and 1% for from100%olive pomace waste raw material, when it record that 100, 94, 91, 83, 34, 11, 2 and 0% after 15, 30, 45, 60, 75, 90, 105, 120, 135 and 150min respectively.

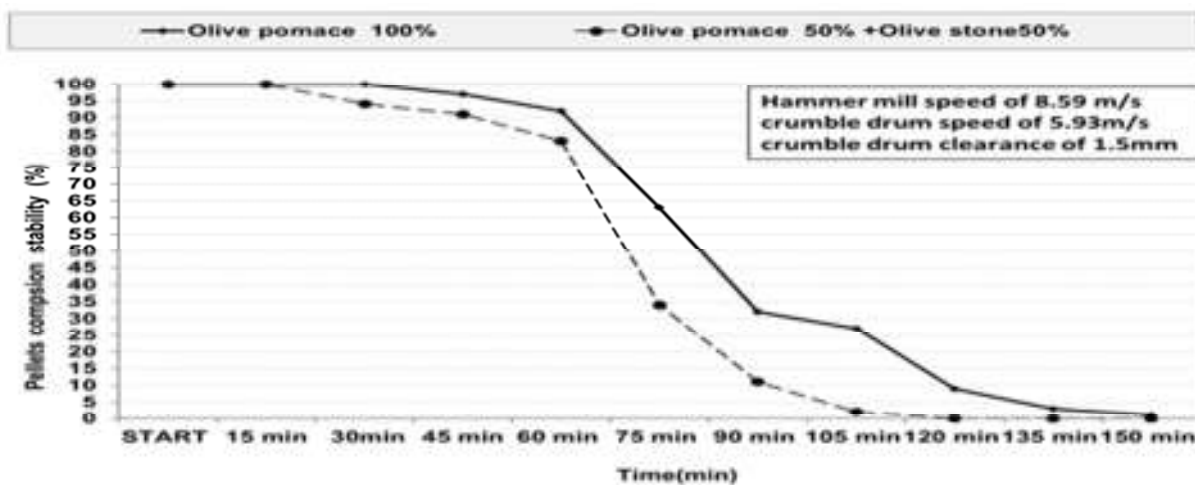

Fig. 7. Effect of bio fuel pellets made from100%olive pomace waste and from50% olive pomace waste with 50%olive stone on pellets stability percentage during combustion

The increase in pellets stability percentage during combustion by using bio fuel pellets made from100%olive pomace waste raw material because it is including high percentage of oil lead to keep the fire for long time more than the bio fuel pellets made from from50% olive pomace waste with 50%olive stone waste raw material.

CONCLUSION

The machine was performance under laboratory and filed conditions such as the effect of milling parameters on milling efficiency and bio fuel pellets quality. We recommended the best operating conditions for the machine at 8.59 m/s hammer mill drum speed, 5.93 m/s

crumble drum speed, 1.5mm clearance between crumble drums. Results were given 0.368 Mg/h for machine production rate, 4.33 kW.h/Mg for specific energy (SE), 46.20% the percentage of granules3mm diameter or less as optimum milled particle size suitable for pelleting, 70.58% bio fuel pellets durability and 83% pellets Stability during combustion after one hour, and recommended use 50% olive pomace with 50% olive stones. We recommended the subject need more research to find out the optimum percentage of pomace with olive stones or add percentage of sawdust as raw material to produce best quality bio fuel pellets able to export to many countries, and use locally too as energy resources in many application in Egypt

REFERENCES

- AACC, (2000) Approved Methods of the American Association of Cereal Chemists. Methods 38-12 and 46-13, 10th ed. American Association of Cereal Chemists, St Paul (MN). Bioprotein production from the waste products of olive oil extraction
- Athanasia, M. and Goula, D. G. (2017). Integrated olive mill waste (OMW) processing toward complete by-product recovery of functional components. Hand book Book Editor(s): Fereidoon Shahidi Apostolos Kiritsakis Chapter (9)
- Economic Affairs Sector statistics Ministry of Agriculture (2017). Annual statistics of olive growing areas and production quantities in Egypt 2017 .
- Ghanbari, R., Anwar, F., Alkharfy, K. M., Gilani, A. H. and Saari, N. (2012). Valuable nutrients and functional bioactives in different parts of olive (*Olea europaea* L.)—a review. *Int J Mol Sci* 13 3291–3340
- Haddadin, M.S, Abdulrahim, S. M., Al-Khawaldeh, G. Y. and Robinson, R. K. (1999). Solid state fermentation of waste pomace from olive processing. *Journal of Chemical Technology and Biotechnology*. Vol. (74), 613:618
- Hunt, D. (1983). Farm power and machinery management. 8th Ed., Iowa State University, Press Ames, U.S.A, PP.29.
- Ibrahim, M. K. E. (1982). Wet milling wheat grain. *M. Sc. Th., Fac. of Agric. Mansoura Univ.* 64 – 65.
- Inarejos-García, A. M., Fregapane, G. and Salvador, M. D. (2011). Effect of crushing on olive paste and virgin olive oil minor components. *European Food Research and Technology*, 232(3), 441–451
- José, S. T., José, M. A. and María, C. P. (2006). Improvement of fluidized-bed dryers for drying solid waste (olive pomace) in olive oil mills. *Eur. J. Lipid Sci. Technol.* 108 (2006) 913–924.
- Juan, J. P., David, G. A., Lucía, O. G., Alegría, C. P. and Selina, C. W. (2018). Impact of industrial hammer mill rotor speed on extraction efficiency and quality of extra virgin olive oil. *Food Chemistry Journal* 242 (2018) 362–368
- Karapmar, M. and Worgan, J. T. (1983). Bio-protein production from the waste products of olive oil extraction, *Journal of Chemical Technology and Biotechnology*. *Biotechnology Volume 33, Issue 3*
- Paloma, M. and María, J. N. (2017). Olive-derived biomass as a source of energy and chemicals. *Wiley Online Library*. Vol(11)1077–1094.
- Veillet, S., Tomao, V., Bornard, I., Ruiz, K. and Chemat, F. (2009). Chemical changes in virgin olive oils as a function of crushing systems: Stone mill and hammer crusher *Comptes Rendus Chimie*, 12(8), 895–904.

تصنيع آلة طحن جديدة لإنتاج الوقود الحيوي من مخلفات الزيتون المطحونة

أسامة قدور¹ و محمد إبراهيم الديداموني²

¹قسم العلوم الهندسية – كلية الثروة السمكية – جامعة السويس

²قسم الهندسة الزراعية – كلية الزراعة – جامعه طنطا

تمثل مخلفات مصانع الزيتون عبئا كبيرا لمنتجي زيوت الزيتون والملح حيث تتراكم هذه المخلفات في المصانع من تفل العصر وبذور الزيتون بكميات كبيرة وتشغل مساحة كبيرة داخل المصانع بالإضافة لإصدارها لروائح كريهة تؤثر بيئيا علي مناطق الانتاج وتعيق حصول اصحاب المصانع علي شهادات اعتماد الجودة – اجريت هذه التجربة عام 2018 بأحد المصانع المنتجة لزيت الزيتون والمخللات وهي واحدة من اكبر الشركات في هذا المجال في الشرق الأوسط بغرض تصنيع الية ميكانيكية لطحن مخلفات الزيتون من التفل والبذور لانتاج مطحون المخلفات لاستخدامها كقوالب للوقود الحيوي وتعتمد فكرة البحث علي استخدام نظريات الطحن المختلفة في طحن مخلفات الزيتون التي تحتوي علي نسبة عالية من الزيوت والتي فشلت وحدات الطحن بالطرق في التعامل معها حيث تم استخدام مرحلتين للطحن الاولي طحن بالطرق واستخدام غربال للطحن ذو ثقوب 5 مم ثم استخدام درافيل تقطيت كمرحلة ثانية للوصول لدرجات النعومة التي تسمح بكبس المخلفات في صورة مكعبات وتم اجراء بعض التجارب العملية الأولية لتحديد عوامل الدراسة وكانت كالتالي: 1- سرعة درفيل الطحن بالطرق وتم استخدام السرعات: 5.25 – 6.46 – 8.59 – 10.41 م/ث. 2- سرعة درفيل التقطيت وتم استخدام السرعات الاتية: 4.46 – 5.93 – 7.19 م/ث. 3- الخلوص بين درافيل التقطيت وتم استخدام خلوص: 1.5 – 2.5 مم. 4- استخدام نسب مختلفة من مخلفات التفل في عمليات الطحن حيث تم استخدام نسبة (100% من التفل) وكذلك نسبة (50% من مخلفة تفل العصر و 50% من بذور الزيتون). وتم دراسة تأثير هذه العوامل علي انتاجية التقنية الميكانيكية والطاقة المستهلكة لإنتاج وحدة الكتلة من نواتج الطحن وكذلك نسبة حبيبات الطحن ذات اقطار 3 مم او اقل في نواتج الطحن وتم استخدام نواتج الطحن في انتاج مصبغات للوقود الحيوي واختبار مقاومتها للصددمات والتداول وايضا اختيار العوامل الافضل وتقدير مدي ثبات هذه المصبغات للاشتعال لفترات الزمنية المختلفة وقد اشارت النتائج ان افضل المعاملات هي : سرعة درفيل الطحن بالطرق 8.59 م/ث وسرعة درفيل المفتت 5.93 م/ث وخلوص بين درافيل التقطيت 1.5 مم ثم اختيار خلطة (التفل 50% + البذور 50%) افضل رغم ثبات خلطة (تفل الزيتون بنسبة 100%) في الاشتعال لفترة اكبر وذلك لانبعاث الاذخنة من هذه النسبة بشكل كبير مما يؤدي الي التأثير علي البيئة. وكانت افضل النتائج كالاتي: 0.368 ميغا جرام/ساعة للإنتاجية و 4.33 كيلووات ساعة /ميغا جرام و 46.2% نسبة الحبيبات ذات اقطار اقل من 3 مم و 70.58% مقاومة المكعبات للصددمات والتداول و 83% نسبة ثبات المكعبات للاشتعال بعد ساعة من بداية الاحتراق واوصي الباحثين بإجراء مزيد من التجارب علي النسب المثلي لإنتاج الوقود الحيوي