



1 THE PRODUCTION OF HOLLOW ARTICLES FROM TUBES
2 BY CONSTRAINED UPSETTING TECHNIQUE

3 O.I.AHMED*, O.ABDEL-AZIM**, M.ABDEL-RAHMAN***

4 ABSTRACT

An investigation is made of the radial upsetting of metallic circular tubes into a die cavity, of different contours, in which an axial collar is produced. A clew to the metal flow mode is given, the physical plane model of deformation is suggested and the corresponding triangular velocity field is constructed. An upper bound solution is utilized for finding the upsetting load. The theoretical predicted load values are compared with those obtained experimentally.

Pressure rating tests of the produced articles are performed. Distribution of wall thickness strain and hardness values are determined and discussed.

*Associate Professor, Dept. of Mechanical Engineering, Assiut University, Assiut, Egypt. **Associate Professor, ***Graduate Student, Dept. of Mechanical Engineering, Minia University, Minia, Egypt.

INTRODUCTION

Metallic adapters have considerable commercial importance and are used extensively in industrial fittings and hydraulic systems such as machine elements and domestic water systems. These components are normally made by casting or by machining methods. In metal casting, the need for cores, runners and feeder systems along with the probable casting defects may impair the production efficiency. On the other hand, the efficient material utilization cannot be achieved in metal-machining.

In recent years, a hydraulic tube-forming machine has been especially designed and manufactured, by Limb and others [1], to investigate the cold forming of axisymmetric and asymmetric components from circular tubes. The process depends on deforming the tube under the combined action of an internal fluid pressure and an axial compressive load. To minimize the wall thinning and to avoid the premature fracture or gross buckling that is likely to occur, a load control system is essential. Also, great care should be exercised for effective sealing of both tube ends during the forming operation. Using a different technical approach, Al-Hassani [2] studied the free expansion or reduction of circular thin-walled aluminium tubes by means of high strength transient magnetic field. The fields are produced by sudden discharge of a bank of capacitors through robust coils placed inside or outside of the tubes. Because of the high capital cost of the capacitors needed for forming relatively large components, this magnetic forming process is only recommended for model scale studies.

The purpose of the present work is to examine the possibility of producing adapters, having an axial collar of a desired shape, from cylindrical tubes using the conventional upsetting technique. Some effort is devoted for understanding of the basic features of the deformation process. Adapters produced are presented and an examination of their quality is made.

EXPERIMENTAL

Equipment

Figure 1(a) shows the general arrangement of the apparatus used in the present series of experiments. Die cavity shapes and dimensions are shown in Figure 1(b). These cavities are designed so as to have the same cross-sectional area. Their contours are manufactured by milling and then finished on an electric-discharge machine. Punches and containers of a nominal bore 24 mm diameter are hardened and then ground to achieve a close running fit at their interface. The experiments are conducted on an upstroking hydraulic press of 2 MN capacity. The applied load is measured at every 1 mm movement of the press ram.

Specimens

Two materials are used; commercial-purity aluminium and copper. The flow curves determined from the uniaxial compression test results are shown plotted in figure 2. These curves, in the region of uniform plastic deformation could be expressed by the familiar parabolic relationship:

$$\sigma = c \epsilon^n \quad (1)$$

where; n is the strain-hardening exponent and c is the strength coefficient.

The 0.2 percent off-set yield strength Y_0 can be deduced according to Cahoon's [3] relationship:

$$Y_0 = \frac{VHN}{3} (0.1)^n \quad (2)$$

where; VHN is the Vickers pyramide number.

Used materials, their annealing conditions and mechanical properties are listed in Table 1. Tubes are of 24 mm outside diameter and 3 mm wall thickness. A lead core, which requires a low flow pressure and a relatively low melting point, is produced by casting the molten lead inside the tubes. After cooling the billets are machined to 50 mm length.

Table 1

material	annealing conditions	material constants		hardness in annealed state (VHN) MN.m ⁻²	0.2% off-set Yield strength MN.m ⁻²
		c MN.m ⁻²	n		
copper	650°C-1h; water quenched	380	0.26	520	84
commercial purity aluminium	350°C-1h; furnace cooled	170	0.3	270	45

RESULTS AND CONSIDERATIONS

Upsetting Loads

Figs.3 and 4 both show the load-displacement diagrams of the upsetting billets of Al/Pb and Cu/Pb respectively, using different die contours. In general, the upsetting load basically Passes through three characteristic stages as deformation proceeds. In the first stage, the billet geometry is rearranged to take up the clearance at the containers bore and the plastic deformation zone is developed, hence the radial upsetting begins to take place. This stage is characterised by a rapid non-linear increase in the punch load with punch travel. In the second stage, as the punch movement proceeds, the billet material flows laterally into the die cavity and the load-displacement curve increases in a linear form. The difference between the slope of curves in Fig.3 and those in Fig.4 is attributed to the work hardening characteristics of the tube material.

The third stage starts when the billet material comes into contact with the die walls and is distinguished by a rapid increase in the punch load towards the complete filling of the die cavity. During this stage, it appears that, the die shape has little effect on the upsetting load, for the same deformed area. This stage is purposely terminated just near the complete filling of the die cavity, otherwise the load can be infinite.

The Upper-Bound Solution

To demonstrate the mode of metal flow prevailing during the second stage, three portions aluminium specimens of 50 mm length are prepared. The bottom portion is equal in length to the bore height left in the lower container (i.e. 10 mm) and the length of middle portion is equal to the die height (i.e. 12 mm). Alignment between the three portions is maintained by applying a thin film of an adhesive cement and then they are kept inside the container to set under pressure. The upsetting is then performed with the punch travel limited to 11 mm so that the specimen deformation stopped at near the end of second stage, using the circular die. The upset component is sectioned longitudinally along the meridian plane and then examined and photographed, Fig.5.

Based on the observed flow pattern, physical plane diagrams, which satisfy the principle of constancy of volume, are constructed as shown in Figs.6 (i) and (iv). In constructing these diagrams, two points are taken into account. First, it is assumed that, the original wall thickness in regions A, C and E remain constant. Experimental measurements indicate that, this is a reasonable assumption. Second, angles θ and β are the two arbitrary angles which determine the pattern of deformation. The associated hodographs, under plane strain conditions, can then be drawn. To avoid confusion that may arise from too many lines, only the hodograph for $\theta=65^\circ$ and $\beta=35^\circ$ is given in Fig.6(ii).

To get an estimate of the upsetting load, it is considered that the plastic work is dissipated by shearing across the velocity discontinuities and by friction at the tool/billet interfaces. According to the upper-bound theorem put forward by Johnson and Mellor [4] for plane strain conditions, later extended by Holloway et al. [5] for axisymmetric forming applications, the upper bound upsetting pressure p is

$$p = A_0^{-1} \int \left(\frac{v}{U}\right)^2 \{K_t A_t + K_c A_c\} \quad (3)$$

where; A_0 is the billet cross sectional area. K_t & K_c are the shear stresses required to sustain the plastic flow of the tube and core materials respectively, A_t & A_c are their respective surface areas generated by rotating the slip lines of Figs.6(i) & (iv) about the billet axis. v is the hodograph velocity and U is the unit velocity.

The material is assumed to obey von Mises yield criterion and the shear stress are given by $K_t = Y_t/\sqrt{3}$ and $K_c = Y_c/\sqrt{3}$ where Y_t and Y_c are the current yield stresses of tube and core materials respectively. Mean values of Y_t & Y_c , corresponding to the mean effective strain imparted on the deformed material, [6], are used in this study.

Where the material is in contact with the tooling, Holloway et al [5] assumed that, the frictional resistance contribution τ_s is only some fraction of the flow strength Y_0 of the undeformed material, accordingly

$$\tau_s = m Y_0 \quad (4)$$

$$(0 \leq m \leq 1.0)$$

Using equations (3) and (4), the upsetting load is calculated for a series

of deformation modes of Figs.6(iii) & (iv) by varying θ and β and a field giving the lowest upper-bound load is found at $\theta=60^\circ$ and $\beta=30^\circ$. Lowest load values, for various values of the boundary shear factor, are then plotted against the corresponding measured loads as shown in Fig.7. Load correlation of Fig.7 showed, in agreement with deductions of Holloway et al [5] that, consideration of $m=0.3$ yield reasonably to a good estimate of upsetting load.

Component Properties

Figure 8 shows a typical photographic view of the upset Products. Visual examination of these products indicated a perfect match between the final product shape and the prespecified geometrical die profile.

Following the visual examination, some of the produced adapters are longitudinally sectioned along the meridian plane for wall thickness measurements. The thickness strain patterns show a general trend as illustrated in Figs. 9(a)-9(d). In all the cases, the cylindrical tube portions are slightly thickened due to their straining to fill in the clearance between the initial billet diameter and the containers bore. In the collar region, however, the wall thickness varies considerably along its length. The collar wall shows increased thickness nearby the cylindrical tube portion that provide the collar with material during its formation. On the other hand, the collar wall is thinned at the stationary punch side, and maximum thinning strains occur at the collar-tube junction. Looking at the photographic view of metal flow, Fig.5, and the physical models of Fig.6, thickness variations in the collar region can immediately be referred to the nature of the process adopted in this work. To eliminate the unfavorable wall thinning, the use of double action press may offer the solution.

After thickness determination, the sectioned specimens are utilized for hardness measurements and the results are shown plotted in Figs.10(a) and 10(b) for copper and aluminium specimens respectively. Fig.10(a) shows that, while both cylindrical ends retain the initial annealed hardness, the collar region displays the maximum hardness reflecting the influence of cold work exercised. In Fig.10(b), the hardness pattern, however, indicate more or less uniform distribution along section. This is a direct result of thermal effects that specimens are subjected to, in lead core removal by melting at 380°C . Eventually, at this temperature, the aluminium softens and reverts to a strain-free state.

Beside the above mentioned examinations, the adapters pressure rating is conducted so that a useful range of application could be established. In their test, the adapters are sealed at both ends, then a hydraulic oil is pumped inside them while observing the pressure monitor. For circular, hexagonal, square and oval collar aluminium adapters the maximum pressures attained are 20, 19, 14 and 13.5 MN/m^2 respectively. At these pressures, the oil is suddenly blown out through holes burst in the wall. Examinations of adapters, after tests, reveal that the rupture invariably occurred at the locations of the most thin zone of the adapters. For copper adapters, when pressure is increased to 49 MN/m^2 a buckle is observed at the slim junction. However, no rupture occurs even when pressure is raised up to 75 MN/m^2 the value at which the test is terminated.

CONCLUSIONS

Within the scope of present investigation, the following conclusions may be drawn.

The processing method adopted in this paper looks very promising, it is simple to apply and thus has useful practical applications especially for the production of hollow articles of geometrically complicated forms and thin sections.

The mode of deformation is revealed. The pressure required to upset bi-metallic cylindrical tubes, of two dissimilar metals, using the upper-bound solution is calculated. Comparison between calculated and the corresponding measured load values shows good agreement.

In order to increase the usefulness of the proposed technique, further effort is still needed as far as uniformity of wall thickness is concerned.

REFERENCES

1. Limb, M.E., Chakrabarty, J., Garber, S., and Mellor, P.B., "The Forming of Axisymmetric and Asymmetric Components from Tube" MTDR, 14, 799-805 (1973).
2. Al-Hassani, S.T.S., "Scale Model Testing in Magnetic Forming of Tubes". MTDR, 14, 815-822, (1973).
3. Cahoon, J.B., Broughton, W.H., and Kutzak, A.R., Metall Trans., 2, 1979-1983, (1971).
4. Johnson, W., and Mellor, P.B., "Plasticity for Mechanical Engineering", D. Van Nostrand Company, (1962).
5. Holloway, C., Bassett, M.B., and Sheppard, T., "On load Pressure Requirements During The Cold Extrusion of Composite Materials" MTDR, 18, 389 - 399 (1977).
6. Abdel-Rahman, M., "A Study of Free and Constrained Upsetting of Cylindrical Billets", M.Sc. Thesis. Minia University. Egypt (1983).

- A: Upper container
- B: Lower container
- C: Die
- D: Moving punch
- E: Stationary punch
- F: Backing plate
- G: Base plate
- H: Top plate cover

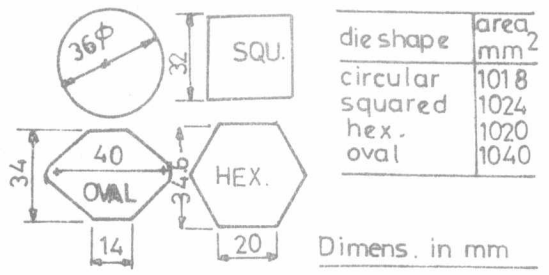
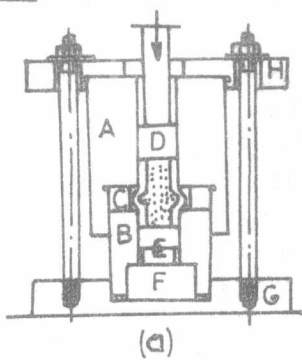

die shape	area, mm ²
circular	1018
squared	1024
hex.	1020
oval	1040

Dimens. in mm

Fig.1.(a)General layout of tooling (b)Shapes of dies used.

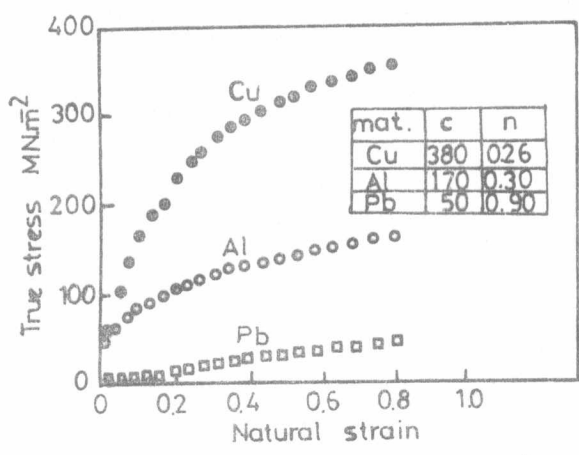

Fig.2.Stress strain curves.

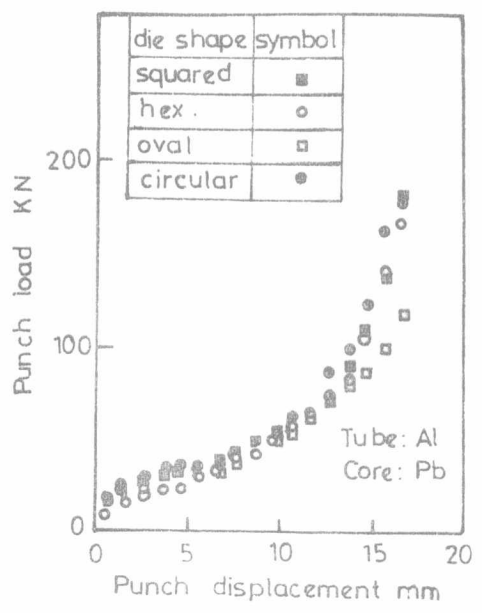

Fig.3.Variation of upsetting load with punch displacement.

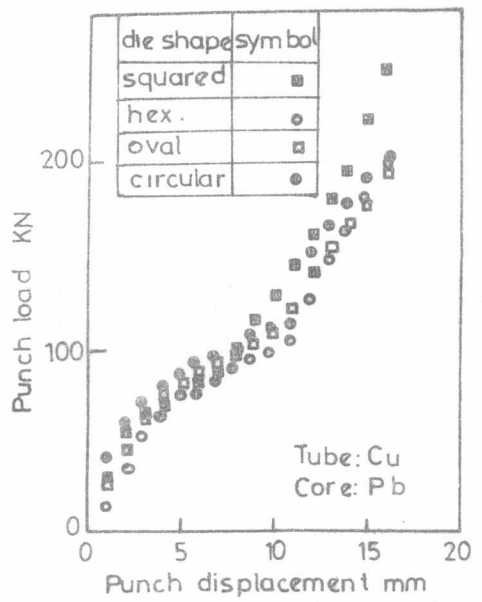
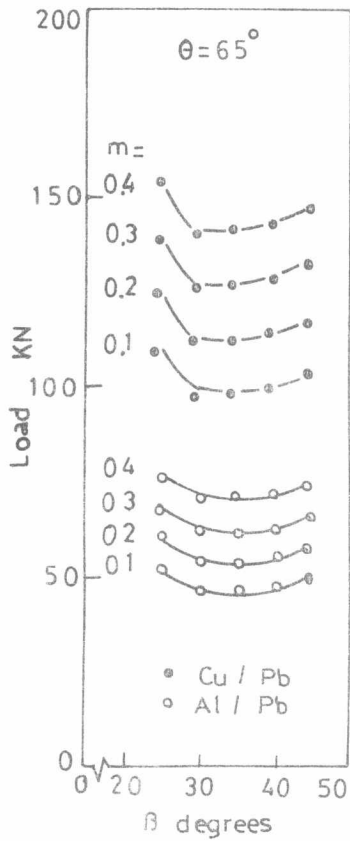

Fig.4.Variation of upsetting load with punch displacement.



Fig.5.Flow of material in shaped section.



(iii) Load against β

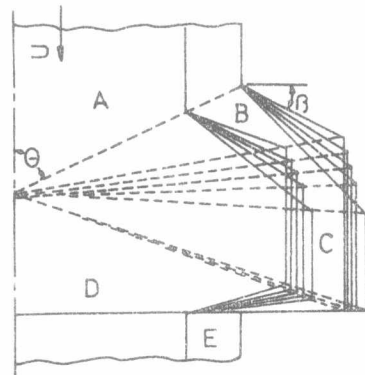

(ii) Physical plane diagram, $\theta=65^\circ$

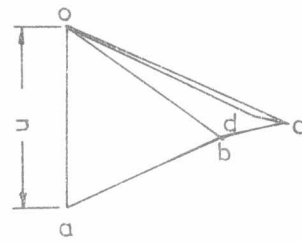

(ii) Hodograph $\theta=65^\circ, \beta=35^\circ$

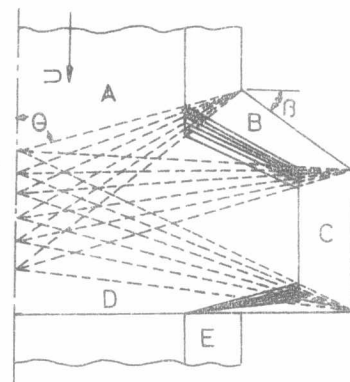

(iv) Physical plane diagram, $\beta=30^\circ$

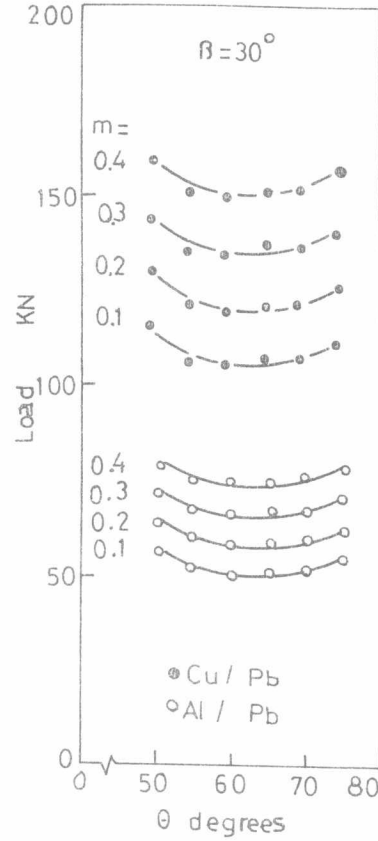

(v) Load against θ

Fig.6. Upper bound solution for the upsetting process.

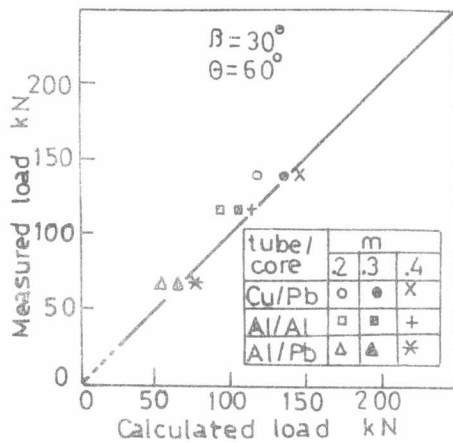

Fig.7. Comparison between experimental and calculated load values.



Fig.8. Shapes of produced components.

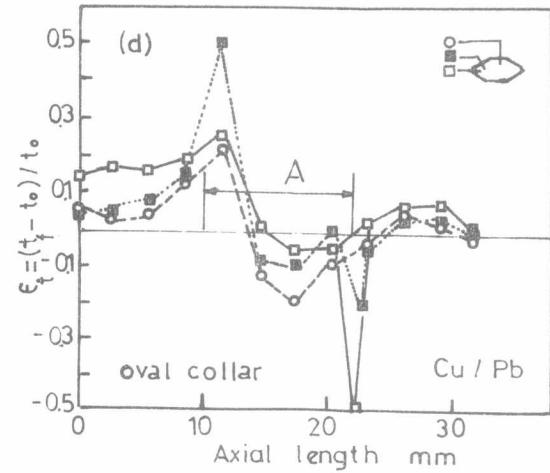
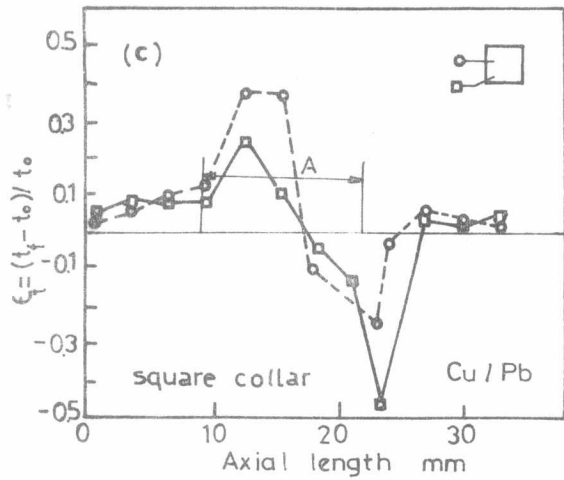
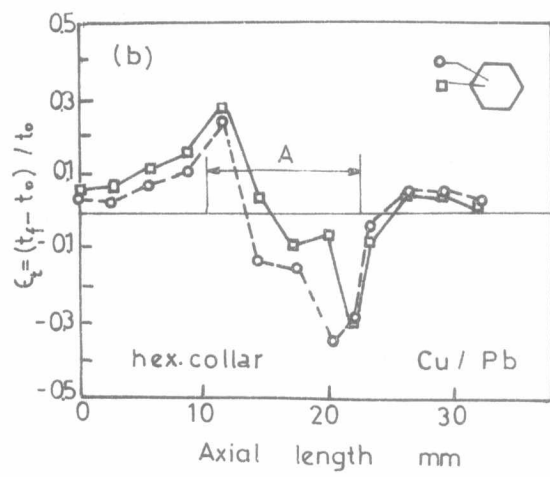
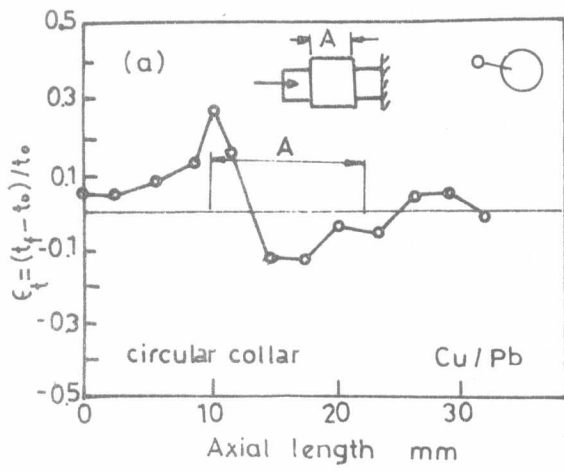

Fig.9. Variation of thickness strain for various adapter shapes.

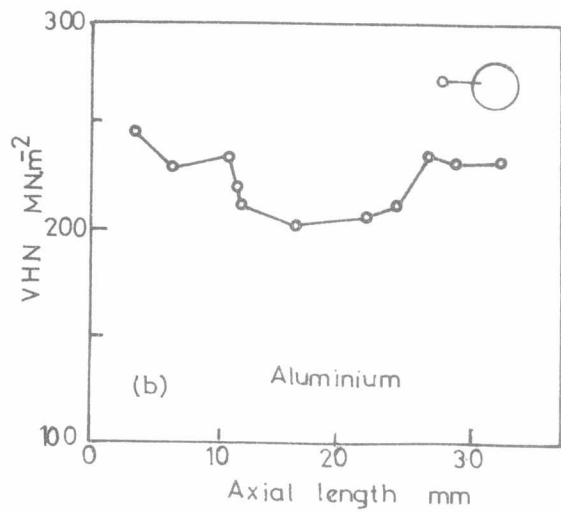
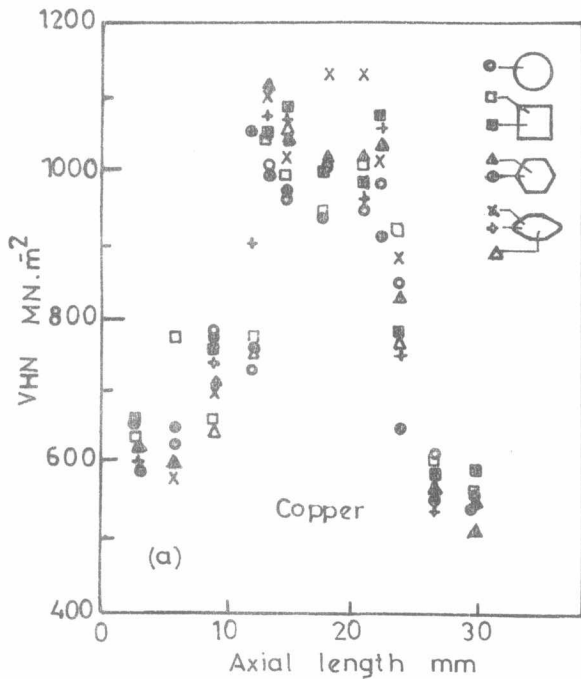

Fig.10. Vickers hardness distribution on sectioned Cu. and Al. adapters.

