



IMPROVING WATER HARVESTING TECHNIQUES IN WADI EL RAML-MATROUH-EGYPT

Ehab E. Abd-El Aaty^{1*}, M.M. Morad², M.K. Afifi² and S.F.T. Sharkawy¹

1. Soil and Water Conserv. Dept., Des. Res. Cent., Egypt

2. Agric. Eng. Dept., Fac. Agric., Zagazig Univ., Egypt

Received: 09/11/2016 ; Accepted: 05/12/2016

ABSTRACT: A water harvesting machine was manufactured to be suitable for rainfall water harvesting in farm through different techniques under rainfed agriculture conditions to maximize crop and water productivity. Field experiments were established at Wadi El Raml, Matrouh Governorate in 2014 and 2015 growing winter seasons to plant wheat crop (Sakha94) variety as an indicators for evaluating water harvesting techniques. The water harvesting machine was studied through different water harvesting techniques by using three geometric reservoirs shapes (triangle, trapezoid and half circle) under three forward speeds. Water harvesting techniques were compared with the traditional method in terms of moisture content, water storage, runoff volume, water use efficiency, crop yield and the operational costs. The experimental results for the successful season (2015) reveal to the following: For water harvesting machine parameters: The lowest speed 2.5km/hr., with geometric reservoir shapes (half circle) refereed to achieve the optimum reservoirs shape in soil. For water harvesting techniques parameters. Water harvesting technique (WHCCSc) which used compacted catchment area for target area with creating half circle shape in the target area is considered the optimum technique to be used by the new manufacturing machine to achieve the highest value of harvested water and crop yield.

Key words: Water harvesting, infiltration, moisture, rainfall, catchment, pits, runoff.

INTRODUCTION

Dry areas cover 41% of the world's land surface, and the majority of the world's poor. A number of factors including water scarcity, drought and land degradation limit agriculture in these areas.

Low rainfall affects the agricultural activities in these areas. Rainfall is characterized by its low value and uneven distribution. In addition, most of the rainwater is lost by soil surface through turbulent flow and runoff to different small valleys. Several factors can affect agricultural production, but water is the most important factor (Oweis and Hachum, 2003).

There is now increasing interest in the low cost alternative generally refer to as 'Water Harvesting techniques in different methods, for

example water harvesting machine, water storage for supplementary irrigation.

Rainwater harvesting is defined as a method for inducing, collecting, storing, and conserving local surface runoff for agriculture in arid and semi-arid regions, Rainwater harvesting may include micro-catchment or macro-catchment runoff farming.

In Egypt, rain is the main source for agricultural activity and areas, particularly in north-west coastal zone and in north Sinai. There is rainfed agriculture area of about 350.7 thousand faddans in the north-west coastal zone of Egypt. The total amount of rain water of Egypt coastal zone is about 1.56×10^9 m³/year on 1400 km² area (700×20 km). The rainfed areas cover about 2.5 million faddans in the northwestern coastal zone of Egypt with 500km long and 20 km width (El-Mowlhi *et al.*, 1998).

*Corresponding author: Tel. : +20-01004208952

E-mail address: Ehab_desert@yahoo.com

Abu-Awwad and Shatanawi (1997) pointed out that water harvesting works best on soil having slopes with surface crust and low infiltration rates, when the soil has enough moisture.

Mwangi (1998) stated that stored water in soil forms the cheapest storage for soil moisture and that the soil in cropped area should be deep for maximum storage and have high water holding capacity.

Nigigi (2003) stated that rain water harvesting is considered as the single most important means to increase agricultural productivity and provide a source of domestic water supply in drought prone areas.

Awlachev *et al.* (2005) mentioned that sustainability of rain water harvesting (RWH) is based on reliable water supply and production, effectiveness of water use (increase rainwater productivity) and minimal negative impacts on natural resources. RWH systems are generally categorized into two; in-situ water conservation practices, small basins, pits, bunds/ridges; and runoff-based systems (catchment and/or storage)

Abu-Zreig and Tamimi (2011) evaluated the efficiency of a relatively new water harvesting techniques, called sand ditch, for moisture and soil conservation. The results showed that sand-ditch techniques significantly reduced runoff and sediments loss and increased infiltration and soil moisture. The efficiency of sand ditch may be decrease with time as the eroded sediments accumulate on the surface of sand ditch, filling its pore spaces and eventually reduce its infiltration rate and water storage. However, efficiency of sand ditch may also increase over time as deposited coarse particles may enhance its storage capability over time and reduce evaporation.

The objective of the present study was to:

1. Harvest rain water in north western coastal zone for agricultural purposes.
2. Manufacturing and testing of water harvesting machine suitable for rainfall water harvesting through different techniques under rainfed agriculture conditions.
3. Study some different operating parameters affecting the performance of the manufactured machine.

4. Compare between the different water harvesting techniques and traditional method.

MATERIALS AND METHODS

Field experiments were carried out in a farm, at Wadi El-Raml which located in North-Western Coast, Mersa Matrouh Governorate, Egypt (Latitude: 31 15\ 35\, N) and (Longitude: 27 09\ 43\, E). The surface gradient of the field was 9%, It was determined by utilization of level instrument Abney level through taking the soil surface elevation every 5m from the middle of each site.

The mechanical analysis of the experimental soil was classified as sandy loam soil (Table 1).

Materials

The cultivated crop

Wheat (Sakha 94) variety was cultivated during the agricultural season of 2014-2015.

The used equipments

Tractor

A four wheel tractor was used as a power source with the following specification: model-Belarus, engine type-diesel, 4 cylinders, power at rated speed 75hp (55.14 kW), PTO speeds-540 rpm and mass 4000kg.

Chisel plow

A chisel plow of 7 shanks, mass 130Kg, width 150cm and height 80cm was used.

The manufacturing water of harvesting machine

A new water harvesting machine was manufactured to be suitable for in field water harvesting under rainfed agriculture conditions. The water harvesting machine consists mainly of the following main parts (Fig. 1).

Heavy roller

A heavy roller was manufacturing from iron with thickness of 6 mm and weight 400 kg. The roller width is 2 m and its diameter is 1m. The Outer surface of the roller was perforated at equal distance to install the reservoirs.

Table 1. Some soil physical properties of the experimental site

Soil depth Cm	Bulk density (g/cm ³)	Sand (%)		Silt (%)	Clay (%)	Texture	Field capacity (%)	O.M (%)	N (%)	P ppm	K mg/100g	Ca CO ₃ (%)
		Coarse	Fine									
0-20	1.58	52.95	24.61	12.55	9.89	S.L*	16.2	0.18	6.8	12	0.21	4.63
20-40	1.62	48.29	24.27	17.32	10.12	S.L*	19	0.48	4.2	10	0.36	6.74

* Sandy Loam.

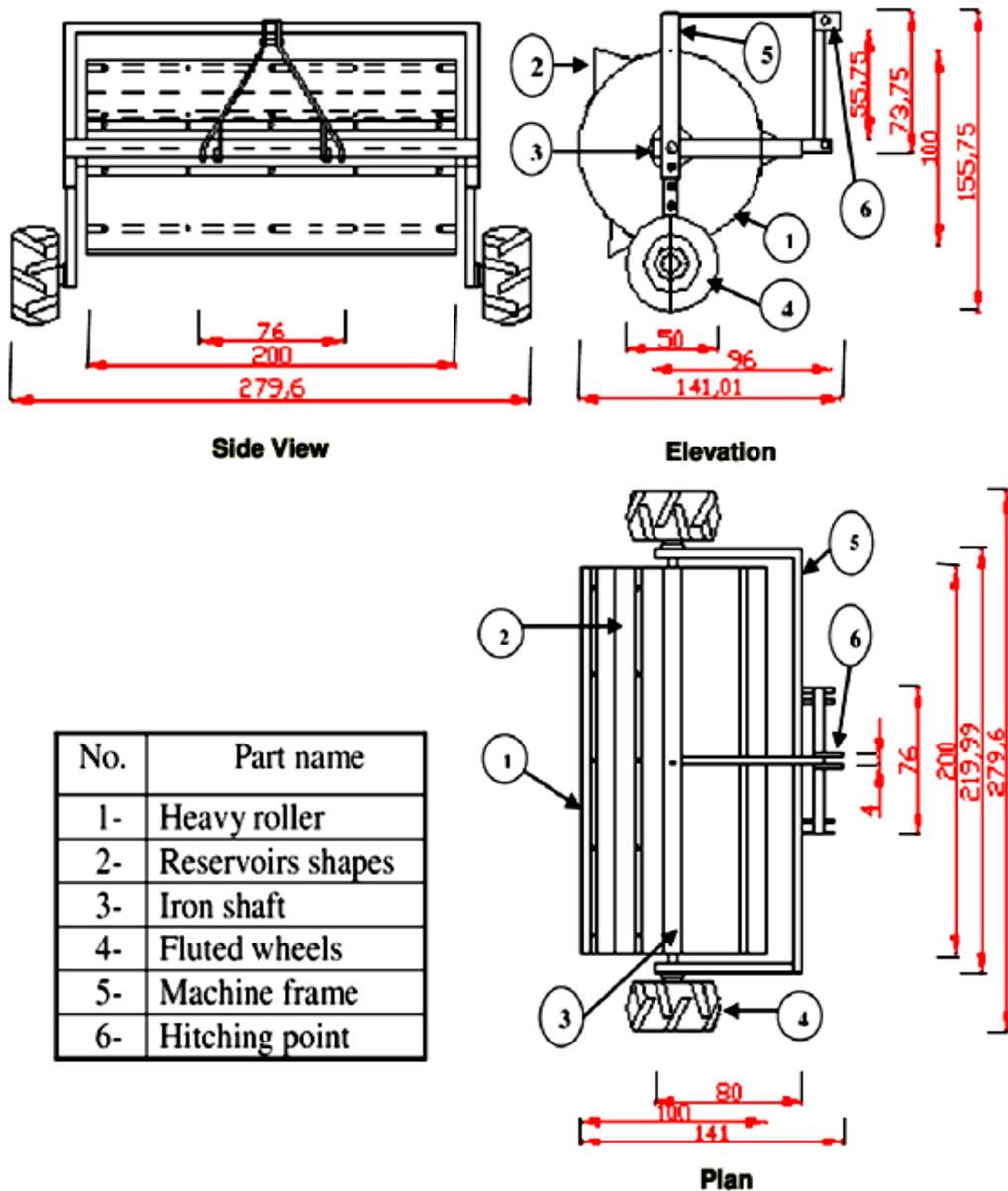

Fig. 1. Schematic diagram of manufacturing water harvesting machine (cm)

Reservoirs

Nine geometric reservoirs with three different shapes were manufactured (3 triangle, 3 trapezoid and 3 half circle). The all different shapes had the same volume of 31400 cm³ with dimensions (157cm²×200cm). The weight of every shape was about 70kg. Every three shapes from the same type were installed on the outer surface of the roller and joined in the holes by screw bolts (Fig. 2).

Iron shaft

The shaft is made from iron steel with 60 mm diameter. The shaft is supported by two bearings. The heavy roller is supported on the shaft by means of iron bars and bolts so as to take its motion.

Fluted wheel

Two fluted wheels with diameter of 70 cm were used to carry the machine.

Machine frame

The machine frame was made from iron steel (I) section with thickness of 12cm.

Hitching device

Three hitching points were fabricated to hitch the machine with the tractor.

Methods

The experimental area was about 10800m², divided into nine equal plots (1200m² each). The dimension of each plot was 20×60 m.

Experimental conditions

Experiments were conducted under the following conditions:

Water harvesting methods:

- Traditional method
- New techniques method

-Water harvesting techniques:

- Without catchment area
- With normal catchment area (3:1)
- With compacted catchment area (3:1)

- Geometric reservoirs shapes:

- WHSt_r (triangle shape)

- WHSt_z (trapezoid shape)

- WHSt_c (half circle shape)

-Water harvesting machine speeds 2.5, 3.5 and 4.5 km/hr.

Experimental design

The field experimental design and treatments were shown in Fig. 3.

Nine treatments were carried out as follows:

- 1- (WHT) water harvesting using traditional cultivation.
- 2- (WHNCT) water harvesting using normal catchment area with traditional cultivation area (3:1).
- 3- (WHCCT) water harvesting using compacted catchment area with traditional cultivation area (3:1).
- 4- (WHCCStr) water harvesting using compacted catchment area with (3:1) triangle shape in cultivated area.
- 5- (WHCCSTz) water harvesting using compacted catchment area with (3:1) trapezoid shape in cultivated area.
- 6- (WHCCSc) water harvesting using compacted catchment area with (3:1) half circle shape in cultivated area.
- 7- (WHSTr) water harvesting using triangle shape under three forward speeds (2.5, 3.5, 4.5 km/hr.).
- 8- (WHSTz) water harvesting using trapezoid shape under three forward speeds forward (2.5, 3.5, 4.5 km/hr.).
- 9- (WHSc) water harvesting using half circle shape under three forward speeds (2.5, 3.5, 4.5 km/hr.).

Measurements and Determinations

The new different techniques of rainwater harvesting in field were evaluated taking into consideration the following indicators:

Machine indicators

Machine field capacity and field efficiency

The field efficiency was calculated by the following formula:

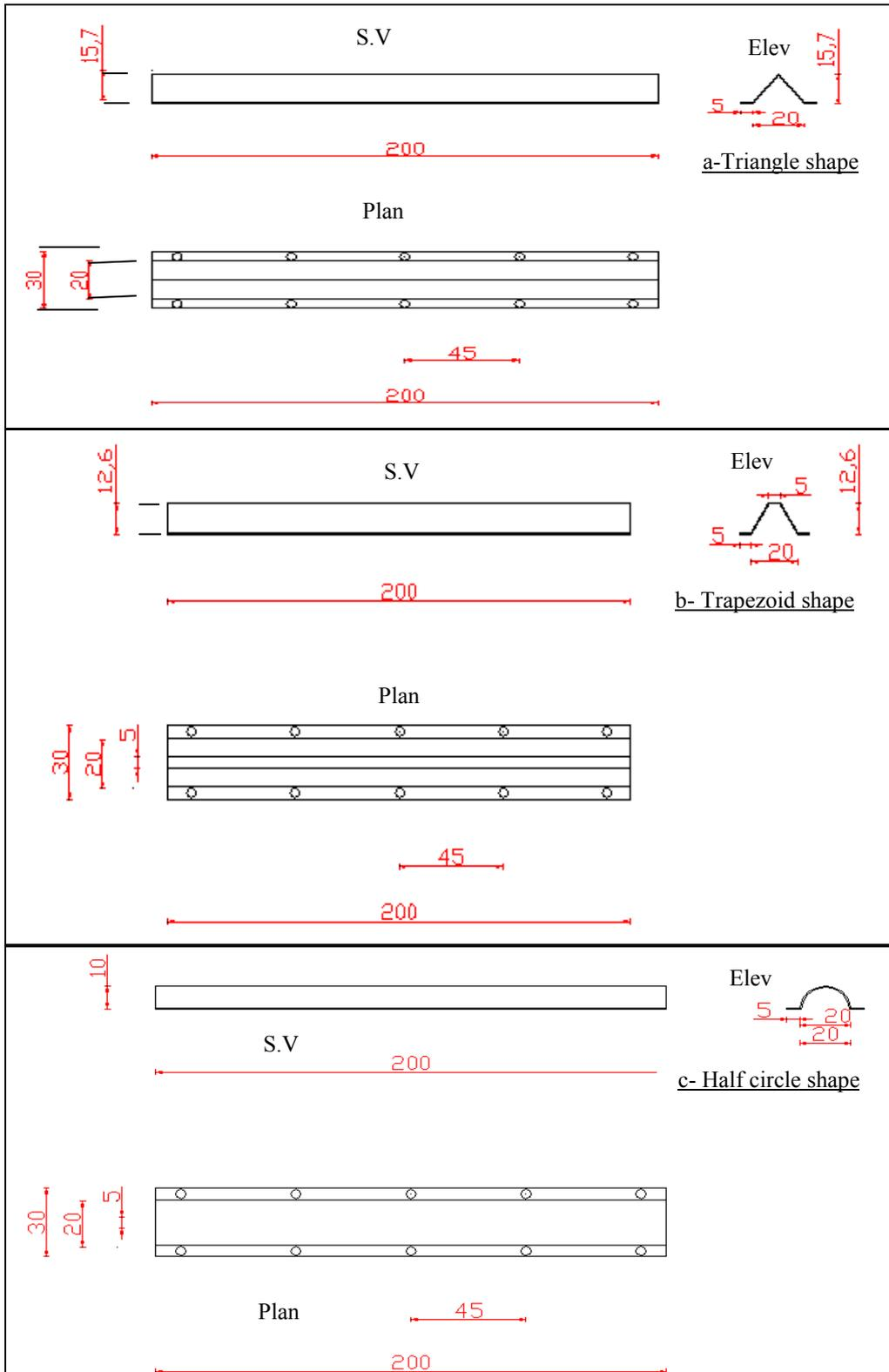

Fig. 2. Schematic diagram of geometric reservoirs shapes (cm)

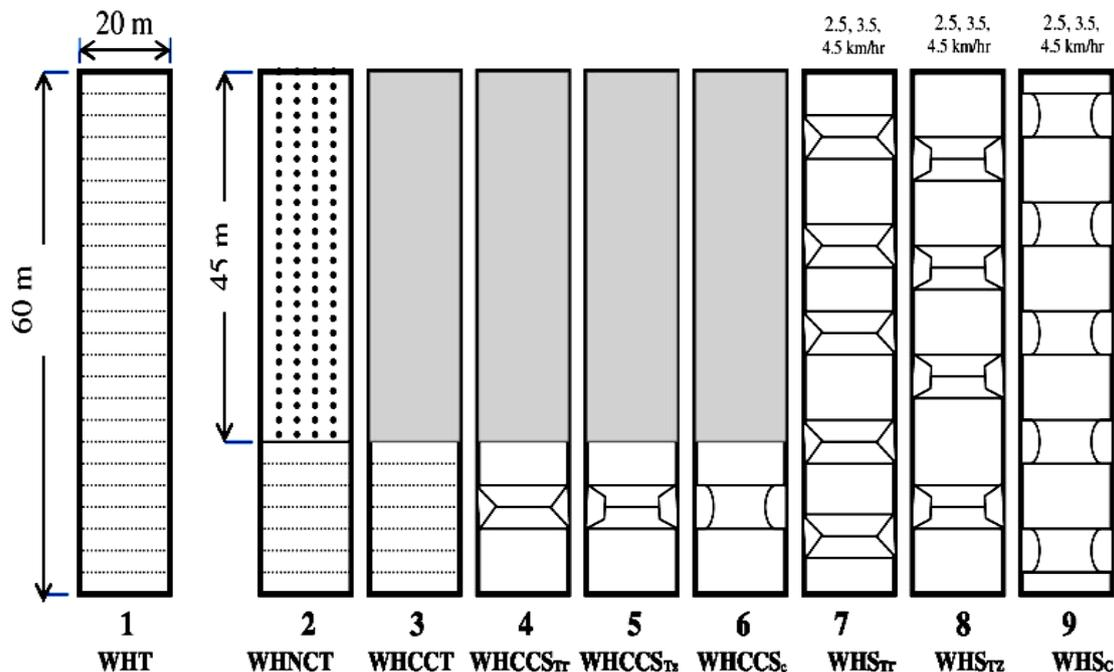

Fig. 3. The experimental field design and treatments

$$\text{Field efficiency (\%)} = \frac{\text{Effective field capacity (fad./hr.)}}{\text{Theoretical field capacity (fad./hr.)}} \times 100$$

Where:

Effective field capacity means the actual average working rate of area and the theoretical field capacity was calculated by multiplying machine forward speed by the effective working width of the machine.

Fuel consumption

Fuel consumption was measured and recorded by accurately measuring the deficits in fuel level tank immediately after executing each operation using graduated cylinder.

The required power

The required power for machine was calculated according to (Barger and Bainer, 1963) by the following formula:

$$\text{Power} = \frac{F.C_h}{60 \times 60} \times \rho_f \times \text{L.C.V.} \times 427 \times \tau_{th} \times \tau_m \times \frac{1}{75} \times \frac{1}{1.36} \dots \text{kW}$$

$F.C_h$ = Fuel consumption l/hr.,

ρ_f = Fuel density (0.85 kg/l for diesel fuel),

LCV=Lower calorific value of fuel 10^4 kCal/kg,

τ_{th} = Thermal efficiency of engine, taken 40%,

τ_m =Mechanical efficiency of engine, taken 80%.

427=Thermo-mechanical equivalent kg. m/kCal.

75 = value of HP, Kg.m/sec

1.36 = one of the hp equal to 1.36 kW

Energy requirements

The energy requirements for the machine operation was calculated by using the following formula:

$$\text{Energy requirements} = \frac{\text{Required power (KW)}}{\text{Effective field capacity (fad./hr.)}}$$

Geometric reservoirs depth

The depths of different shapes which were created in the soil by the manufacturing machine with various speeds were measured by graduated ruler.

Soil indicators

Soil infiltration rate

Infiltration rate was measured by double cylinder method, using Philip (1975) equation as following:

$$IR = \frac{F}{T}$$

$$F = aT^{0.5} + bT$$

Where:

IR= Infiltration rate cm/hr.

T= time, hr.

F= cumulative depth cm/sec.

a,b = constants concerning to soil properties.

Soil penetration resistance

Under three depths of soil (0-10), (10-20) and (20-30), the soil penetration resistance was measured by penetrometer instrument.

Rain water indicators

Rain fall amount

The amount of rain fall for each shower during two winter seasons 2014/2015 was recorded by automatic rain fall gauge which operates as a digital instrument.

Moisture content

Measuring of moisture content in every treatment is considered very important to determine the best water harvesting techniques for water storage in soil profile, Samples of soil taken from point (0-10), (10-20) and (20-30)cm as a depth to determine soil moisture content after 24 hour from rainfall storm event, it was calculated as the following equation:

$$MC (D.b) = \frac{Wd}{Ww} \times 100$$

Where:

MC = soil moisture content, W (%).

Ww = wet soil mass (g).

Wd = dry soil mass (g).

Runoff volume

Runoff volume for every treatment was measured after every shower by runoff gauge (triangular weir), Runoff depth was measured at each collected water runoff by graduated cylinder.

Soil water storage

The amount of soil water storage for all treatments were calculated according to soil moisture content which were taken from soil depth of (0-30) cm, moisture content was converted to water storage through the soil bulk density and depth. It was calculated as the following equation:

$$V_w = (P_v \times A \times D) / 100$$

Where

V_w = volume of water stored in soil, m³

P_v = soil moisture content, (v) (%)

A= soil area, m²

D = Soil depth, m

Crop indicators

Wheat yield

The wheat yield under rainfed condition was determined for every treatment. A number of samples (1m²) for wheat crop were taken from different locations for each treatment, and then harvested and the seeds were weighted and integrated to determine the average yield per faddan.

Water use efficiency

According to the crop yield and soil water storage, water use efficiency was calculated through the following formula:

$$\text{Water use efficiency (kg/m}^3\text{)} = \frac{\text{Crop yield (kg/fad.)}}{\text{Water storage (m}^3\text{/fad.)}}$$

Cost analysis

The hourly cost is determined using the conventional method of estimating both fixed and variable costs.

The operational cost was determined by using the following equation:

$$\text{Operational cost (LE/fad.)} = \frac{\text{Hourly cost (LE/hr.)}}{\text{Effective field capacity (fad./hr.)}}$$

$$\text{Seasonal income (LE/fad.)} = \text{Wheat yield (kg/fad.)} \times \text{Price (LE/kg)}$$

$$\text{Net income (LE/fad.)} = \text{Seasonal income (LE/fad.)} - \text{operational cost (LE/fad.)}$$

RESULTS AND DISCUSSION

The discussion will cover the following main points:

Performance Evaluation of the Water Harvesting Machine at Difference Forward Speed

Field capacity and field efficiency

Fig. 4 shows that increasing machine forward speed from 2.50 to 4.50 km/hr., increased field capacity from 0.89 to 1.77 fad./hr., while decreased field efficiency from 82.70 to 74.80. The major reason for decreasing field efficiency by increasing forward speed is due to the less theoretical time consumed in comparison with the other items of time losses.

Fuel consumption, power and energy requirements

Fig. 5 shows that both fuel consumption and energy requirements decreased as the forward speed increased while the *vice versa* was noticed with the required power. Increasing forward speed from 2.5 to 4.5 km/hr., decreased fuel consumption from 2.80 to 2.40 L/fad., and also decreased energy requirements from 8.80 to 7.45 kW.hr./ fad., while the required power increased from 7.90 to 13.20 kW. The decrease of fuel and energy by increasing forward speed is attributed to the increase of field capacity, results in low values of fuel and energy per faddan.

Depth of geometric reservoirs shapes in soil

Fig. 6 shows that all geometric reservoirs depth decreased with increasing machine forward speed. Triangle shape depth decreased from 8.3 cm to 6.7, trapezoid shape decreased from 6.5 cm to 5.8 cm and half circle shape decreased from 8.2 cm to 7.3 cm with increasing machine forward speed from 2.5 to 4.5 km/hr. The obtained results show that the optimum reservoir shape was half circle shape because it keeps the reservoir. This attributed to that the outer surface of the half circle shape contacts very well with the surface of the soil as well as it facilitate of rotation that decreases friction with the soil surface during operation, making it easier to penetrate most of the soil shape during the formation process.

Evaluation of Rain Fall Data

Fig. 7 shows the cumulative rainfall and rainfall amount for every storm which observed in situ of wadi El-Raml during the successful agricultural season of 2015/2016 during the period from November to April. Total rain fall reached to 107.6 mm, the lowest storm was 1.6 mm recorded on 22/11/2016 and the highest storm recorded 26 mm on 20/12/2015. Generally rainfall storm was concentrated in November, December and January. Every storm was more than 10mm is considered effective rain storm which generate water runoff and saturation. The total effective storm was recorded from agriculture date 14November to the end of season was 79.6mm and one effective storm 10.8mm was occurred before two weeks from agricultural season.

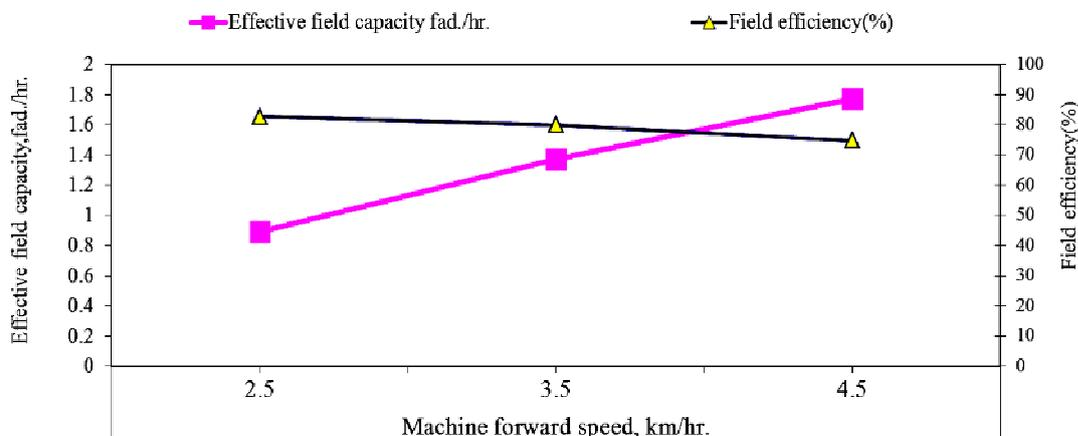

Fig. 4. Effect of machine forward speed on field capacity and field efficiency

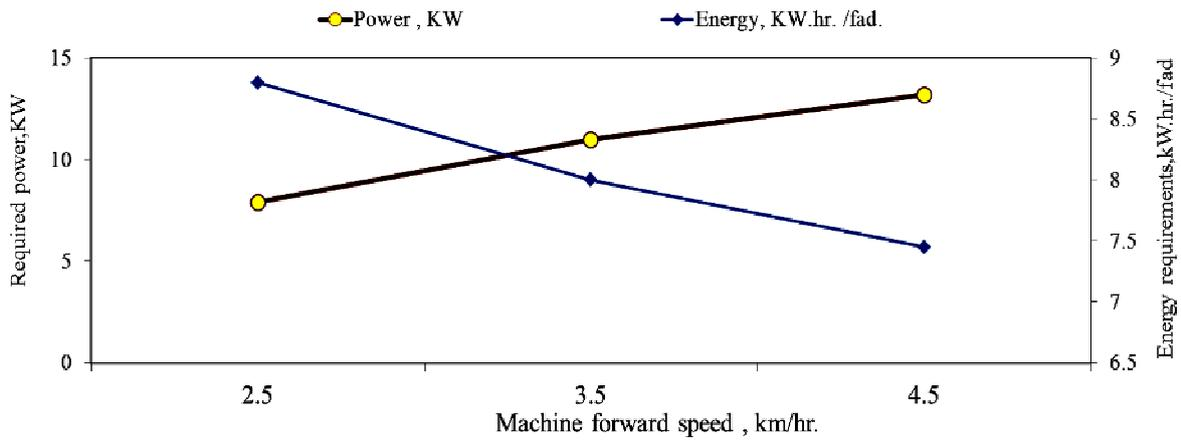

Fig.5. Effect of machine forward speed on fuel consumption, Power and energy requirements

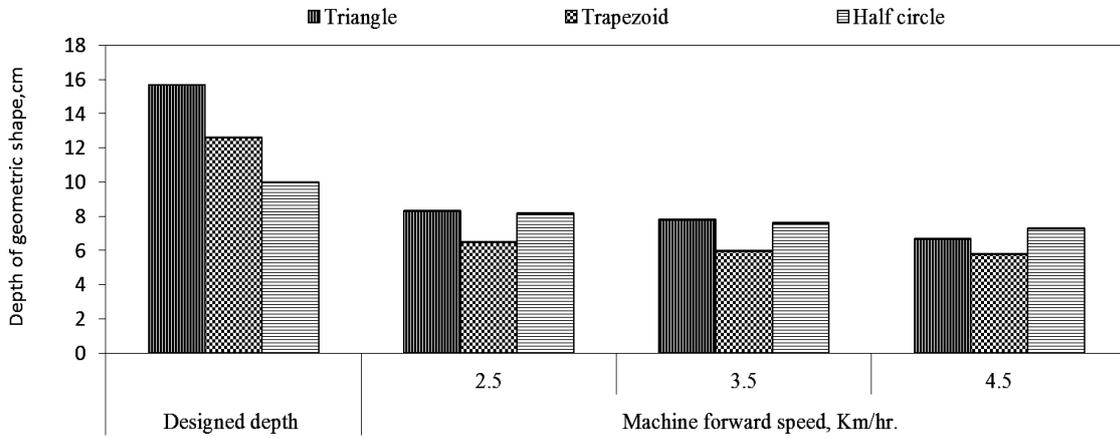

Fig .6. Effect of machine forward speed on depth of geometric reservoirs shape in soil

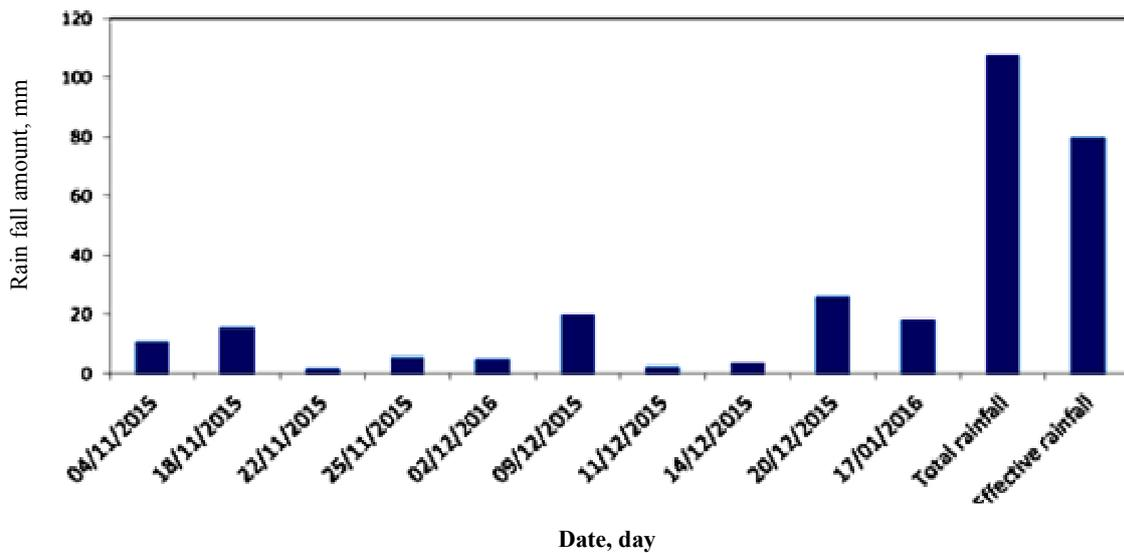

Fig. 7. Rain fall data

Evaluation of Water Harvesting Techniques

Soil penetration resistance

Fig. 8 shows the values of soil penetration resistance for tillage area, normal catchment area and compacted catchment area under three depths (0-10, 10-20, and 20-30). Compacted catchment area recorded the highest values of 1.13, 1.13 and 1.14 MPa under soil depths, 0-10, 10-20 and 20-30, respectively. In *verse versa* the lowest values of 0.34, 0.96 and 1.10 MPa were recorded for tillage area under the same depths. This is due to that compacting soil increases the convergence of soil particles and decreases the disintegration of the surface layer and porosity which causes the increasing in soil penetration resistance compared to the tillage soil.

Soil moisture content

Fig. 9 shows the deferentially effect of water harvesting techniques on the average soil moisture content at soil depth of (0-30) under rainfall storms.

Results in Fig. 9-a shows that the water harvesting technique (WHCCT) compacted catchment area for traditional cultivated area, recorded the highest value of soil moisture content which ranged from 10.63 to 17.80% with the first rain storm 15.4 mm and the end storm 18.2 compared to (WHNCT-water harvesting using normal catchment for traditional cultivation) and (WHT-traditional method). (WHCCT) recorded the highest moisture content

value compared to the other methods because, the prone compressible water catchment area in the soil are the most resistant to penetration and thus it is the lowest in the leaching rate compared to the normal catchment area, so water run off rate increased from the compacted area to the cultivated area which increase water recharge in soil and raised soil moisture content.

Fig. 9-b shows that increasing machine forward speed from 2.5 to 4.5 km/hr., with all geometric shapes decreased soil moisture content. The half circle shape (WHSc) recorded the highest value of soil moisture content 10.43, 11.56, 15.47 and 17.1% with rain storms 15.4, 20, 26 and 18.2 mm, respectively under the lowest forward speed of 2.5 km/hr., this is due to that decreasing machine forward speed increased the depth of reservoirs shapes in soil and half circle shape had the best depth in the configuration and conformation in soil profile compared to the other shapes.

Fig. 9-c shows that the technique (WHCCSc-compact catchment area and creating half circle shape in cultivated area) recorded the highest values of soil moisture content, 11.73, 12.80, 16.83 and 18.30% with storms, 15.4, 20, 26 and 18.2 mm. This is due to that compacted catchment area increased water runoff to the cultivated area and half circle shape is the optimum shape which captures highest water runoff compared to other shapes.

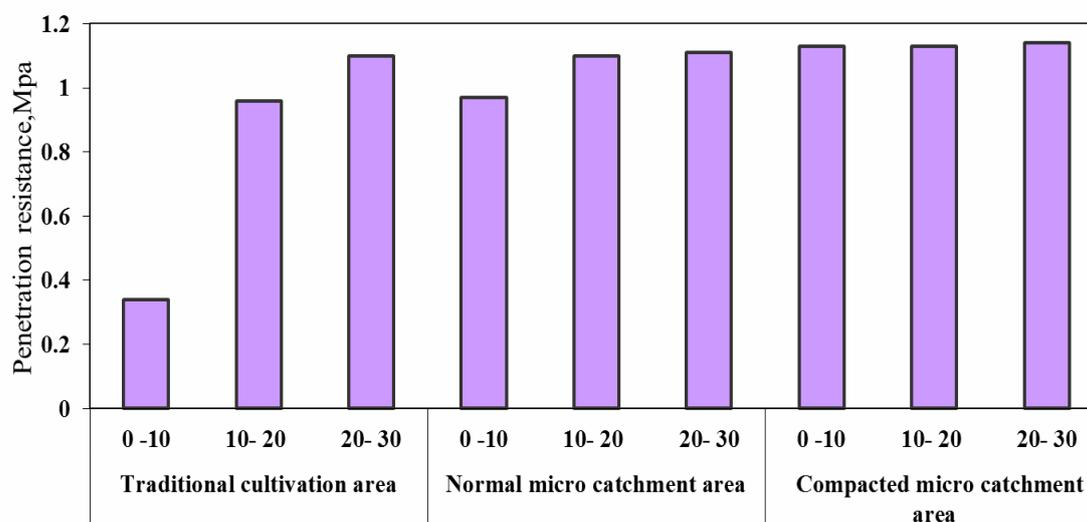
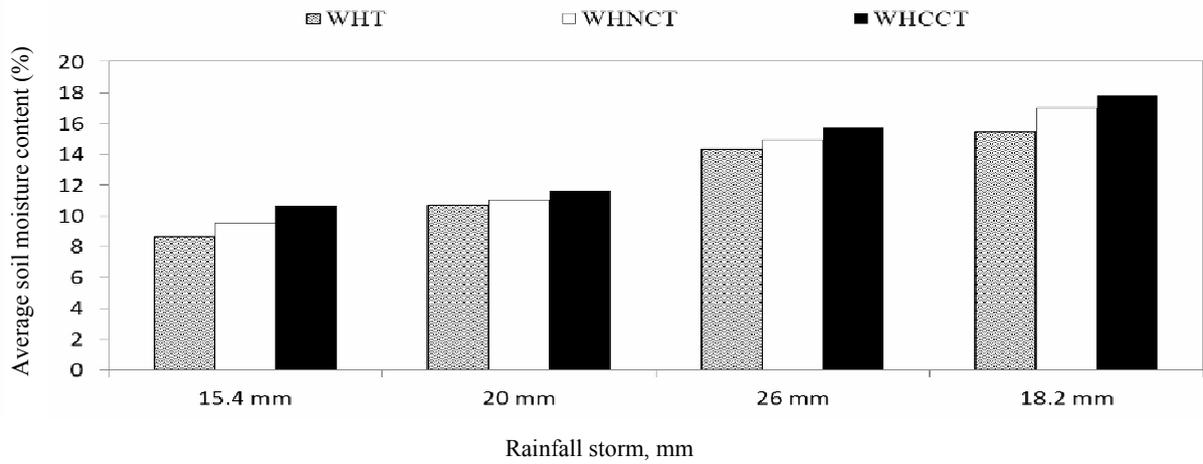
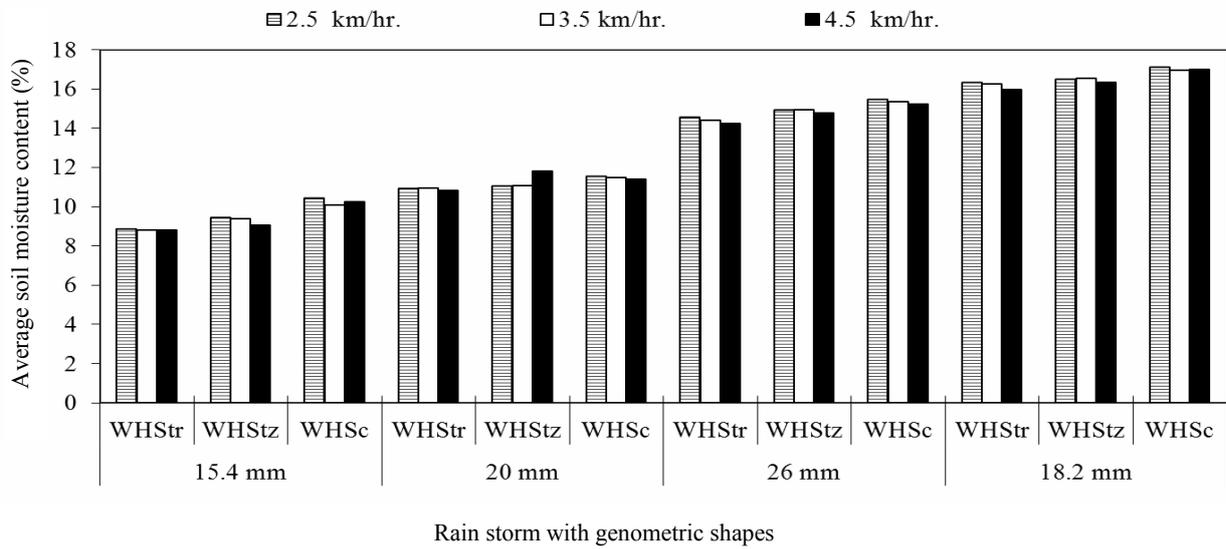

Fig. 8. Penetration resistance values for tillage area, normal catchment area and compacted catchment area



(a)



(b)

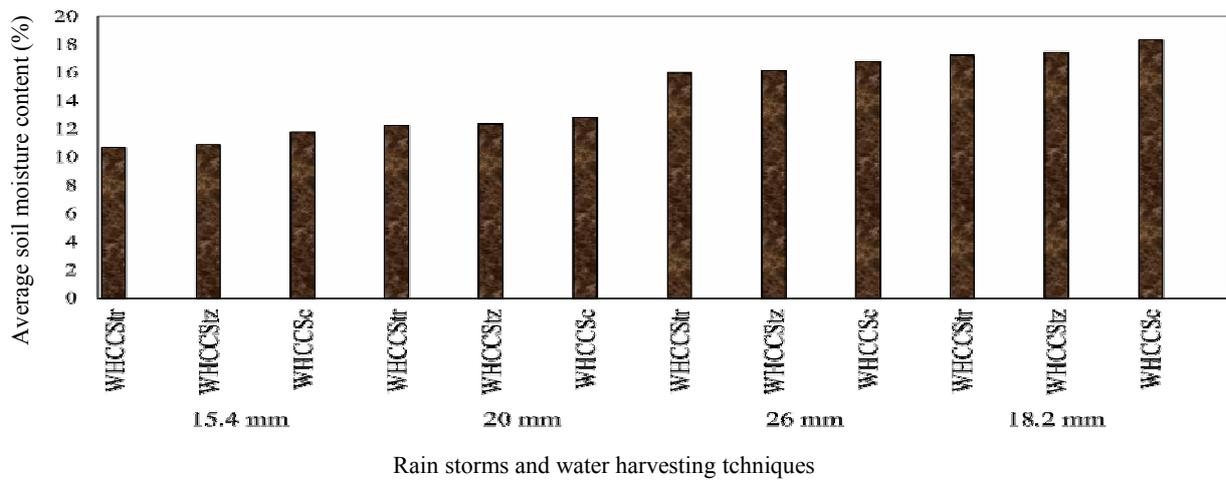

(c)

Fig. 9. Effect of water harvesting techniques on average soil moisture content

Soil water storage

Fig. 10 shows the differential effect of water harvesting techniques on the average soil water storage at soil depth of (0-30) under rainfall storms.

Results in Fig. 10-a show that water harvesting technique (WHCCT-compact catchment area for traditional cultivated area) recorded the highest value of soil water storage which ranged from 71.43 to 119.61 m³/fad., with the first rain storm 15.4 mm and the end storm 18.2 compared to (WHNCT-water harvesting using normal catchment for traditional cultivation) and (WHT-traditional water harvesting method). The technique (WHCCT) recorded the highest value of soil water storage compared to the other methods because it is considered the highest in the amount of soil resistance to penetration which making it the lowest in infiltration rate so increased water runoff toward the target surface area and raised soil water storage as compared to non-compact area and tillage area.

Fig. 10-b shows the effect of machine forward speed and geometric reservoirs shapes on the average water storage under rain storms. Results showed that increasing machine forward speed from 2.5 to 4.5 km/hr., with all geometric shapes decreased the depth of shapes in soil which caused decreasing in soil water storage. The half circle shape recorded the highest value of water storage 70.09, 77.68, 103.98 and 114.90 m³/fad., with rain storms 15.4, 20, 26 and 18.2 mm, respectively under the lowest forward speed of 2.5 km/hr., this is due to that decreasing machine forward speed increased the depth of reservoirs shapes in soil and half circle shape recorded the highest depth and configuration in soil profile compared to the other shapes.

Fig. 10-c shows the values of average water storage for water harvesting techniques (WHCCStr), (WHCCStz) and (WHCCSc). The technique (WHCCSc-compact catchment area and creating half circle shape in cultivated area) recorded the highest values of average soil water storage, 78.83, 86.02, 113.10 and 122.97 m³/fad., with storms, 15.4, 20, 26 and 18.2 mm, respectively. This is due to that compacted catchment area increased water runoff to the cultivated area and half circle shape is the

optimum shapes which capture highest water runoff compared to other shapes.

Runoff volume

Fig. 11 shows the effect of rain fall storm 15.4, 20, 26 and 18.2 mm events during the agricultural season with water harvesting techniques on runoff volume.

Results showed that increasing rain fall amount increased runoff volume, the highest rainfall storm 26 mm recorded the highest values of runoff with every treatment, and the lowest storm 15.4mm recorded the lowest value.

Compacted catchment area recorded the highest values 0.64, 0.86, 1.1 and 0.76 mm with rain storms 15.4, 20, 26 and 18.2 mm., respectively because the compaction of catchment area decreased soil infiltration rate and increase soil penetration resistance which generate maximum water runoff on surface while the *vice versa* occurred with the method used geometric reservoirs shapes which recorded the lowest values of runoff, specially half circle shape which recorded the lowest values 0.24, 0.32, 0.50 and 0.29 mm with the same storms, this results due to that half circle is considered the deeper shape in soil which control in surface runoff and capture water surface.

Crop productivity

Fig. 12 shows the values of crop productivity with all water harvesting techniques.

Using compacted catchment area and engineering reservoirs shapes in cultivated area as follow (WHCCStr), (WHCCStz) and (WHCCSc) achieved the highest values for crop productivity 915, 940.6 and 1019.5 kg/fad., Compared with using reservoirs shapes without catchment area (WHStr),(WHStz) and (WHSc) which recorded 819.6 , 815 and 890.5 kg/fad., with the lowest speed of 2.5 km/hr. Traditional method (WHT) recorded the lowest value for crop productivity, 634.5kg/fad., while using compacted catchment area for traditional cultivated area (WHCCT) recorded 842.7 kg/fad. Normal catchment area for traditional cultivated area (WHNCT) recorded 758.3 kg/fad.

From results, the optimum method which recorded the highest productivity was (WHCCSc)

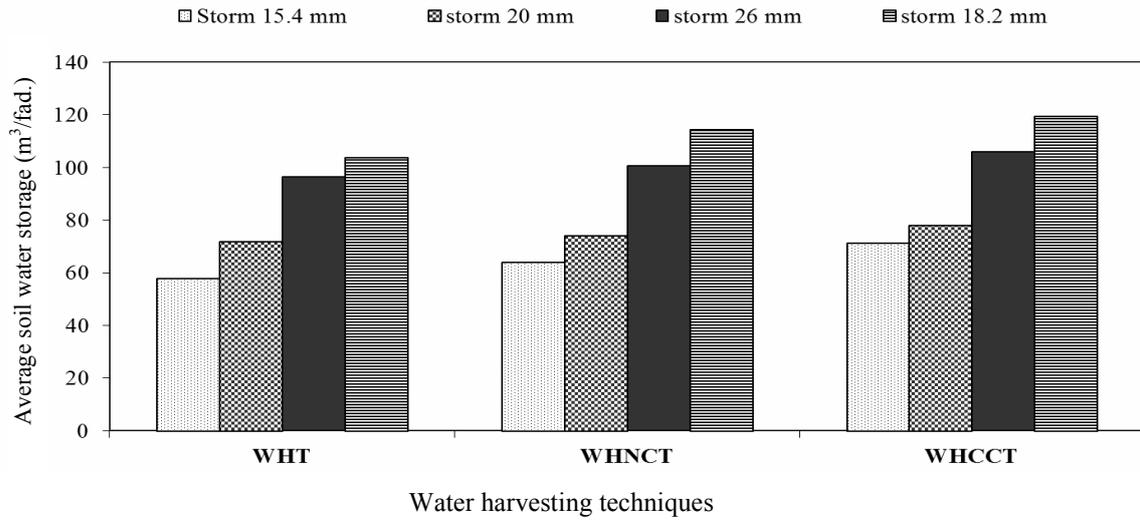

(a)

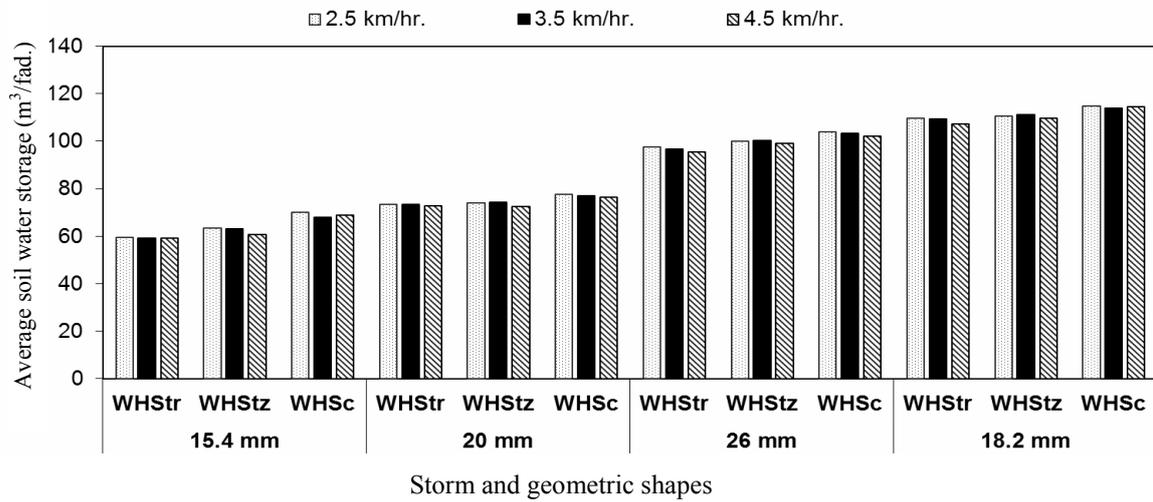

(b)

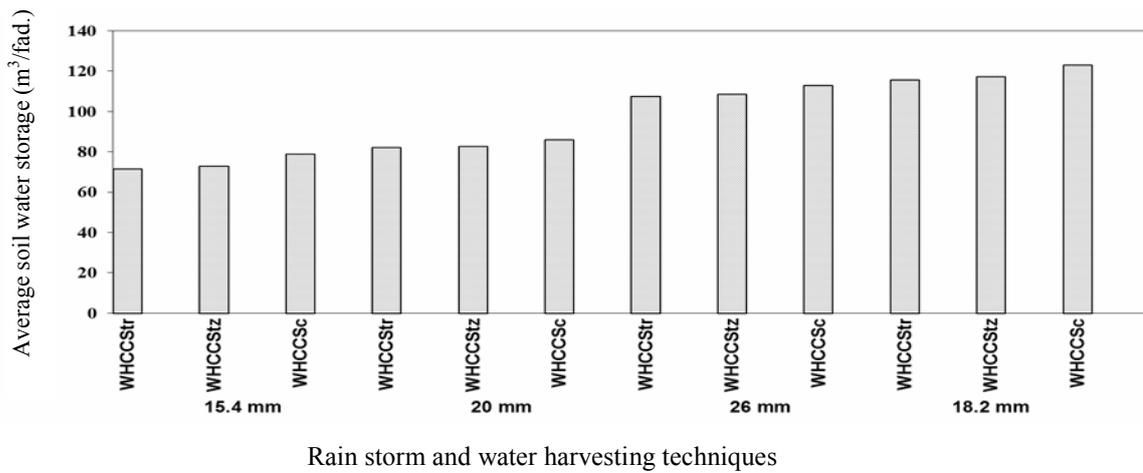

(c)

Fig. 10. Effect of water harvesting techniques on average soil water storage

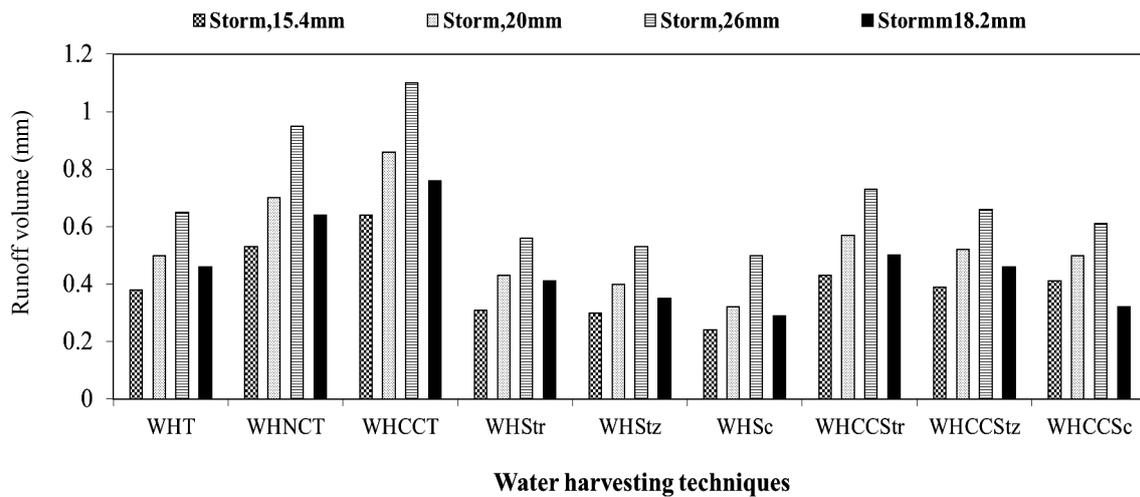

Fig. 11. Effect of water harvesting techniques and rain fall storms on runoff volume

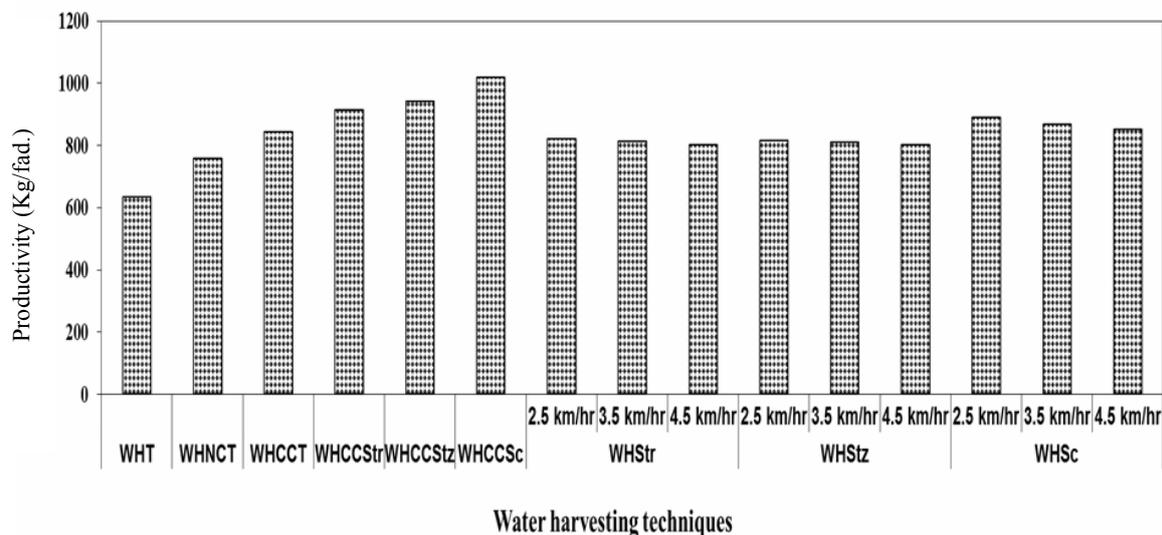

Fig. 12. Effect of water harvesting techniques on crop productivity

because utilization of compacted catchment area increased water runoff to the cultivated area in the same time creating reservoirs with half circle shape in cultivated area increased water storage quantity in soil profile and also captures water runoff.

Effect of water harvesting techniques on water use efficiency

Fig. 13 shows that the highest values of water use efficiency were 2.42, 2.46 and 2.54 kg/m³ which recorded for water harvesting techniques using compacted catchment area and geometric reservoirs shapes in cultivated area as

follow (WHCCStr), (WHCCStz) and (WHCCSc). While traditional method (WHT) recorded the lowest value of water use efficiency of 1.92 kg/m³. From results, the technique (WHCCSc) is considered the optimum technique recorded the highest value, this is due to that compacted catchment area increased water runoff towards the target area and creating half circle shape in the target area assess on conserved the water runoff and increase soil water storage for wheat crop compared to the other techniques, hence, water storage and crop productivity were maximized.

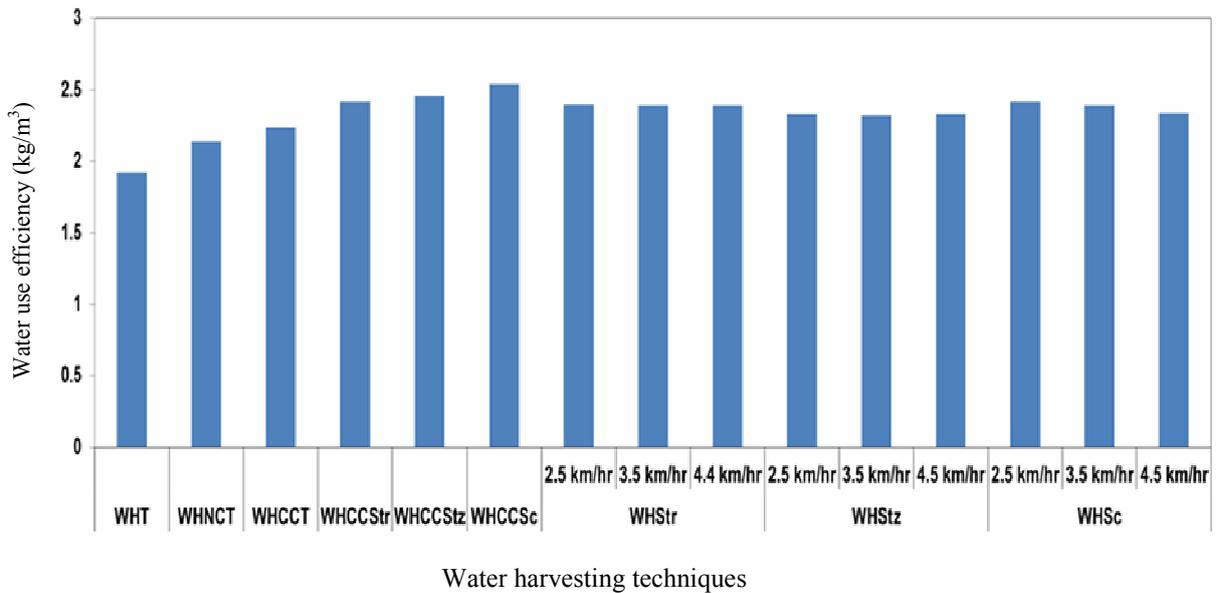

Fig. 13. Effect of difference water harvesting techniques on water use efficiency

Cost Analysis and Seasonal Income

Table 2 shows the operational costs for different water harvesting techniques under rainfed agriculture condition for the variety of crop Wheat Sakha 94.

Water harvesting technique (WHT) gave the lowest value of costs of 60 LE/fad., but gave the lowest value of seasonal income 1902 LE/fad.

Water harvesting technique (WHSc) which used geometric reservoirs shape for example half circle costed 105 LE/fad., with the lowest speed 2.5km/hr., and costed 89 LE/fad., with the medium speed 3.5 km/hr., in the same time this technique gave seasonal income 2670 LE and 2604 LE with speeds 2.5 km/hr., and 3.5 km/hr.

The optimum water harvesting technique (WHCCSc-Compacted catchment area and geometric reservoirs shape half circle in target area with ratio 3:1) achieved the highest value of seasonal income 3057.5 LE with operational cost of 180 LE/fad., under medium speed when

the catchment area was three faddans and the target area was one faddan.

Conclusion

For water harvesting machine parameters

Increasing machine forward speed tended to increase field capacity, and required power but decrease field efficiency, fuel consumption and energy requirements.

For geometric reservoirs shapes parameters

Geometric reservoirs shape (half circle) referred to achieve the optimum reservoirs shape in soil at 2.5 km/hr., forward speed.

For water harvesting techniques parameters

Water harvesting technique (WHCCSc-compacted catchment area for target area with creating half circle shape in the target area) is considered the optimum techniques was used by the new manufacturing machine which achieved the highest value of rain water harvested and water stored in soil and crop yield.

Table 2. Effect of water harvesting technique on total cost

Water harvesting Techniques	Operational cost			Total operational costs LE/fad.	Crop yield Kg/fad.	Seasonal income, LE, for productivity/fad.	Net income
	Tillage costs, LE/fad.	Compacted catchment area, LE/3 fad.	Creating geometric shapes LE/fad.				
WHT	60	-	-	60	634	1902	1842
WHNCT	60	-	-	60	758	2274	2214
WHCCT	60	90	-	150	842	2526	2376
WHCCStr	60	90	30	180	915	2745	2565
WHCCStz	60	90	30	180	940	2820	2640
WHCCSc	60	90	30	180	1019	3057	2877
WHStr	2.5 km/hr.	60	-	105	819	2457	2352
	3.5 km/hr.	60	-	89	812	2436	2347
	4.5 km/hr.	60	-	83	802	2406	2323
WHStz	2.5 km/hr.	60	-	105	815	2445	2340
	3.5 km/hr.	60	-	89	810	2430	2341
	4.5 km/hr.	60	-	83	801	2403	2320
WHSc	2.5 km/hr.	60	-	105	890	2670	2565
	3.5 km/hr.	60	-	89	868	2604	2515
	4.5 km/hr.	60	-	83	852	2556	2473

REFERENCES

- Abu-Awwad, A.M. and M.R. Shatanawi (1997). Water harvesting and infiltration in arid areas affected by surface crust: examples from Jordan, *J. Arid Environ.*, 37: 231-242.
- Abu-Zreig, M. and A., Tamimi (2011). Field evaluation of sand-ditch water harvesting techniques in Jordan, *Agric. Water Manag.*, 98: 1291-1296
- Awlachev, S.B., D.J. Merrey, A.B. Kamara, B. Van Koppen, F. Penning de Vries, E. Boelee and G. Makombe (2005). Experiences and opportunities for promoting small scale/micro irrigation and rainwater harvesting for food security in Ethiopia. Colombo, Sri Lanka: IWMI. v. (Working paper 98), 86.
- Barger, E.L. and R. Bainer (1963). Tractors and Their Power Units, Jon willy and sons Inc. New York, London USA.
- El-Mowlhi, N.M., M.O. Salem and S. Abdel Hafez (1998). On Farm Water Harvesting System. Egyptian Case Study. Book.
- Mwangi, T.H. (1998). Water harvesting an illustrative manual for development of micro catchment techniques for crop production in dry areas, Regional Land Management unit, (RELMA) Swedish Int. Develop. Authority, Nairobi, Kenya.
- Nigigi, S.N. (2003). What is the limit of up-scaling rainwater harvesting in a river basin? *Physics and Chem. Earth.*, 28:943-956.
- Oweis, T. and A. Hachum (2003). Improving water productivity in the dry areas of West Asia and North Africa. In: Kijne, W.J., Barker, R., Molden, D. (Eds.), *Water Prod. Agric.: Limits and Opportunities for Improv.* CABI Publish., Wallingford, UK, 179-197.
- Philip, J.R. (1975). The theory of infiltration, 4. Sorptivity and algebraic infiltration equation. *Soil Sci.*, 84: 257-264.

تحسين تقنيات حصاد المياه في وادي الرمل - مطروح - مصر

إيهاب السيد عبد الرحيم عبد العاطى^١ - محمد محمد مراد^٢محمود خطاب عفيفي^٢ - سعد فوزى تادرس شرقاوى^١

١- قسم صيانة الأراضي - مركز بحوث الصحراء - مصر

٢- قسم الهندسة الزراعية- كلية الزراعة - جامعة الزقازيق - مصر

تم تصنيع آلة ملحقة على الجرار من الخلف تستخدم لحصاد مياه الأمطار بالواديان والأراضي ذات الميول بالمناطق الجافة وشبه الجافة وذلك تحت ظروف الزراعات المطرية وندرة المياه بهدف زيادة مخزون الماء بالتربة مع تقليل معدل الجريان السطحي غير المنتظم من خلال تقنيات جديدة وأساليب حصاد مياه مختلفة يتم تنفيذها بالآلة المصنعة مما يزيد من كفاءة استخدام المياه ورفع إنتاجية المحاصيل وتحقيق التنمية المستدامة، وتم إجراء التجربة في موسمين شتويين (٢٠١٤، ٢٠١٥)، وتتكون الآلة من: معظم الأجزاء الأساسية رولة بقطر واحد متر وعرض ٢ متر مركب عليها أشكال هندسية ذات مقاطع شكل مثلث، نصف دائرة، شبه منحرف، مع وجود ثلاث نقاط شبك وهيكل الآلة، واشتملت التجارب على المتغيرات التالية: السرعة الأمامية: تم استخدام ثلاث سرعات أمامية وهم ٢,٥ ، ٣,٥ ، ٤,٥ كم/ساعة، الأشكال الهندسية: تم استخدام ثلاث اشكال هندسية وهي مثلث، نصف دائرة، شبه منحرف، طرق الحصاد: تم استخدام طرق مختلفة لحصاد المياه وهي: عمل اشكال هندسية بالأرض المنزرعة كلها مع استخدام ثلاث سرعات تشغيل للآلة، عمل أشكال هندسية بالجزء المنزرع من الأرض مع كبس منطقة تجميع للمياه بنسبة ١:٣ بين المنطقة المنزرعة ومنطقة التجميع، زراعة تقليدية بالجزء المنزرع من الأرض مع كبس منطقة تجميع للمياه بنسبة ١:٣ بين المنطقة المنزرعة ومنطقة التجميع، زراعة تقليدية بالجزء المنزرع من الأرض مع عمل منطقة تجميع للمياه بدون كبس بنسبة ١:٣ بين المنطقة المنزرعة ومنطقة التجميع، استخدام الطريقة التقليدية المتبعة بالمنطقة وهي الحراثة في اتجاه عمودي على ميل الأرض وتم مقارنتها بالطرق الأخرى المستخدمة بالآلة المصنعة، وقد تم تقييم أداء نظم حصاد المياه المختلفة من خلال نسبة الرطوبة ومعدلات تخزين المياه بالتربة ومعدلات الجريان السطحي وكفاءته مع تقدير الانتاجية وكفاءة استخدام المياه بالمتر المكعب لكل كيلو جرام إنتاجية، وأظهرت النتائج التجريبية للموسم الناجح الأكثر مطرا (٢٠١٥) الآتي: بالنسبة لتشغيل آلة حصاد المياه المصنعة فان أفضل الاشكال الهندسية المصممة هو شكل نصف الدائرة لأنه أعطى أفضل الأعماق بالتربة لتخزين مياه الأمطار وبالتالي أعطى أفضل معدلات لنسب الرطوبة وكفاءة تخزين المياه والإنتاجية مع السرعة الأقل وهي ٢,٥ كم/ساعة أما من ناحية كفاءة الآلة من حيث السعة الحقلية ومعدلات استهلاك الوقود والطاقة فكان مع السرعة المتوسطة ٣,٥ كم/ساعة، استخدام طريقة حصاد المياه (عمل منطقة تجميع مياه ومنطقة مستهدفة مزروعة بنسبة ١:٣) مع كبس منطقة التجميع وعمل أشكال هندسية بالمنطقة المستهدفة يزيد من معدلات المياه المخزونة بقطاع التربة لمحصول القمح ويعظم الانتاجية .

المحكمون :

١- أ.د. السيد خليفة محمد
 ٢- أ.د. محمود عبد العزيز حسن

أستاذ الهندسة الزراعية - كلية الزراعة - جامعة كفر الشيخ.
 أستاذ الهندسة الزراعية المتفرغ - كلية الزراعة - جامعة الزقازيق.