

Three-Phase Voltage Controller Fed PAM Induction Motor

F.E. Abdel-kader A.E. Abou Mobarka W.S. Abouel-fadl
Dept. of Elect. Eng., Faculty of Eng.
Minufiya University, Shebien El Kom, Egypt.

Abstract :

Speed control of three phase induction motor by pole amplitude modulation technique is to obtain two, three or four speeds. A control technique realize a constant torque, constant power and variable torque operations of this type of motors is presented. This control technique gives an easy and accurate possibility to perform these processes without requiring any additional complecated requirements. Some of the important and interested results verifying the principle of peration and motor performance characteristics are presented and backed up by experiments .

1. Introduction :

Speed control of 3- phase induction motor using pole amplitude modulation technique is to obtain two different speeds or more. There are three methods to control the speed according to the type of load, whether it is : constant torque (CT) , constant power (CP) or variable torque (VT). This type of motors is designed to do one operation since there is only one source with constant voltage used for the two speeds with certain output torque ($T_{f,L}$). If the load is decreased, the applied voltage must be decreased for efficiency improving .

Manuscript received from Dr. W. S ABOEL – FADL on : 17/6/2000

Accepted on : 29/7/2000

Engineering Research Bulletin, Vol 23, No 4, 2000 Minufiya University, Faculty of Engineering , Shebien El-Kom , Egypt, ISSN 1110-1180

The motor may be used to do more than one operation. This also requires the applied voltage to be changed. So, it is necessary to design an electronic circuit to change the applied voltage either in the case of changing the type of operation or to suit with load requirement for the same operation. This voltage controller is connected between the supply and the motor to vary the value of the applied voltage to achieve these requirements.

2. Operation of AC Controller :

A digitally controlled firing circuit to control antiparallel connected controlled thyristor working under phase controlled operation of three phase variable voltage controller has been designed, implemented, tested and put in working order. The firing angle is controlled by a delay angle controlled comparator. The desired firing pulses are modulated with a high frequency square wave generator to overcome the commutation failure due to load variation processes. The modulated pulses are kept all time in synchronization with the supply frequency at zero crossing points. This processes are achieved by a three phase line to neutral signal voltages V_{AN} , V_{BN} and V_{CN} . These three phase voltage signals are converted via an operational amplifier detector that operates as a sine to square wave converter. The output of the sine- square wave converter is converted into a corresponding ramp and synchronized signal to each positive half cycle of each phase. The required time delay angle α that controls the instant of switching is adjusted by a linear variable DC reference voltage. The controlling range is from $0 \leq \alpha \leq 180^\circ$ with a very simple and easy method of controlling.

3. Hardware Description and System Operation :

The complete system block diagram of the proposed digitally controlled antiparallel connected controlled thyristor working under phase controlled operation of a three phase variable voltage controller is shown in Figure (1). The system uses a 3 step down transformers as a signal transducer that produce a three phase 3 volt signal that synchronized with the supply voltage V_{AN} , V_{BN} and V_{CN} . Moreover

these transformers are considered as suitable latching and isolating circuit. The three voltage signals are applied to an amplifier circuit that uses an infinity feedback resistance to allow operation of a synchronized sine -to- square wave converter. The output of the squaring circuit is applied to a ramp function generator through a unijunction transistor

2N 2426 with an intrinsic stand off ratio $\eta = 0.5$. to make sure of zero crossing operation. The output of the ramp voltage generator is controlled by a variable DC reference voltage through a difference voltage comparator. The delaying angle α is determined by the instant of the intersection of both saw tooth " ramp signal " and DC reference voltage. The adjusted firing pulses are frequency modulated with a high frequency modulating signal of 25KHZ. This modulation process is sufficient to overcome the problem of commutation failure of the antiparallel connected voltage controller during sudden change load variation. Finally, these firing pulses are amplified through a power amplifier stage and then buffired through a pulse transformer to protect and match the controlled thyristor requirments.

4. Firing Circuit Overview:

Thyristors are widely used for power control of DC and AC applications. There are many different methods commonly used to provide AC voltage controllers . In phase controlling techniques (phase angle control) a pair of anti- parallel connected thyristores are required. A number of different firing circuits can be used to provide load voltage variation to different loads. In some applications , such as speed control of three - phase motor operates at constant power operation mode, a special firing technique is required. Therefore, a digitally controlled firing circuit shown in Figure (2) is designed , built , tested and put in working order. In this circuit a sample of each line - to - neutral voltage (AC 3 volt amplitude) is fed to a sine -to- square wave converter using infinity feedback resistance operational amplifier to keep zero crossing points of the AC input signal . The output of the sine -to- square wave converter is converted to a ramp

voltage corresponding to the positive half cycle of the AC signal a unijunction transistor wave shaping circuit . The same process is repeated to the negative half cycle to complete phase A . Also the same process is repeated with phase B and C . All of the six ramp signals for positive and negative half cycles are compared with a variable DC voltage to produce a delayed firing pulses with α , $120^\circ + \alpha$ and $240^\circ + \alpha$ where α is the delayed firing angle which varies for a range of 180° .

Finally , the firing pulses are frequency modulated with a high frequency square wave of 25 KHZ. The output of the modulated firing pulses are then power amplified using a power amplifier stage and then buffered using a pulse transformer to isolate the controlled thyristor power circuit and the electronic firing circuit .

Once the controlled thyristor is triggered ON, it conducts and continuous for conducting and carrying the load current due to the generative action of the thyristor after the thyristor is turned ON, the gate pulse is still needed in order to avoid unwanted turn off the thyristor.

Figure(3) illustrates the input 3VAC signals of phases A,B and C. Figure(4) shows the corresponding output square waves of these phases. Figure (5) illustrates both of input 3 V AC signal and the corresponding output wave for phase A. Figure (6) represents both of the square wave input to unijunction transistor and its conversion to a corresponding ramp signal. Figure (7) shows the saw tooth input to the comparator and the controlled firing pulse for the corresponding α . Figure (8) represents both the firing pulse of one phase and the high frequency modulating signal. Figure (9), (10) & (11) represents the firing pulses of the three phases at firing angles 60° , 90° & 110° respectively.

Figure (12) represents the firing signal after modulation for the three phases A,B& C. Figure (13) shows the thyristor gating pulses for the three phases, while Figure (14) represents the thyristor gating pulses for a complete cycle of one phase.

5. Experimental Results:

The performance characteristics of the tested motor are obtained experimentally during the loading using the controlled circuit to change the impressed voltage at each operation. The motor parameters are shown in table(1).

5.1. Voltage and Current Waveforms:

The thyristor control circuit is connected between the electric source and the three phase squirrel cage induction motor. The motor is loaded by another induction motor when its stator windings are excited by a direct current.

Figure (15 a & 15b) shows the voltage waveforms for phases A, B & C at two different firing angles.

Figure (16) (a, b & c) shows the waveforms of the currents at different firing angles for phases A, B & C.

5.2. Performance Characteristics of the Motor:

The three methods of motor operations (CT, CP & VT) are tested. The motor winding connection is modified in each case, while the controlled thyristor circuit is used to adjust the required voltage as shown in table (2).

Figures (17-22) show the experimental results of the variation of speed, input current, input power, efficiency and the power factor with the output torque.

It is observed that the full load values can be obtained at CP operations since the voltage is high.

6. Conclusion :

- Load requirements need motor impressed voltage to be varied in order to improve the motor efficiency.
- A digitally controlled firing circuit to control the thyristor working under phase controlled operation of three phase variable voltage controller has been designed, implemented, tested and put in working order.
- In addition to changing the applied voltage, the thyristor makes soft starting and decreases the starting current.

Appendix I

SCR Specification

Parameter	Description	Rating
V_{RRM}	Reverse repetitive maximum voltage	400V
I_T	Thyristor current	15 A
V_{GT}	Gate trigger voltage	1.5 V
I_{GT}	Gate trigger current .	50 mA

Appendix II

Data of the tested motor :

The data of 3-phase induction motor used in the laboratory measurements are; 0.75 HP., 380/220 V, 1.6/2.77 A, 50 HZ, 1425 r.p.m., 0.71 efficiency, 0.74 power factor, 36 stator slots, 28 rotor slots.

References :

- 1- L.R. Foote, " Adjustable speed control of ac motors" Electric Engineering, Vol. 78, August 1959.
- 2- K.Y.G.Li, " Analysis and operation of an inverter fed variable speed induction motor", Proc. IEE, Vol. 116, September 1969.
- 3- D.A. Paice, "Induction motor speed control by stator voltage control", IEEE Trans. Power App. Syst. Vol. PAS- 87, pp. 585-590, Feb. 1968.
- 4- W. Shepherd and J. Stanway, "The polyphase induction motor controlled by firing angle adjustment of silicon controlled rectifiers", IEEE Int. Conf. Rec. Vol. 7 Pt. 4 , pp. 135 - 154, 1964.
- 5- NEHRIR, M.H., 1975, I.E.E.E. Trans. Ind. Electron. Control Instrum., 22, 43-46.
- 6- W. SHEPHERD, "Thyristor Control of A.C. Circuits", (Bradford University Press) pp. 262 - 269, 1975.

Table (1). Voltage & parameters at different operation

No.	Constant torque		Constant power		Variable torque	
	low speed 1	high speed 2	low speed 3	high speed 4	low speed 5	high speed 6
V	164.5	95.25	110	190.5	95.25	95.25
R1	14.2	3.55	3.55	14.2	14.2	3.55
X1	25	6.17	6.17	25	25	6.17
R2	6	1.2	1.2	2.4	6	1.2
X2	30	3.7	7.5	7.5	30	3.7
R_M	1700	850	425	3400	1700	850
X_M	250	125	62.5	500	250	125

Table (2). Connections of different operations & the voltages.

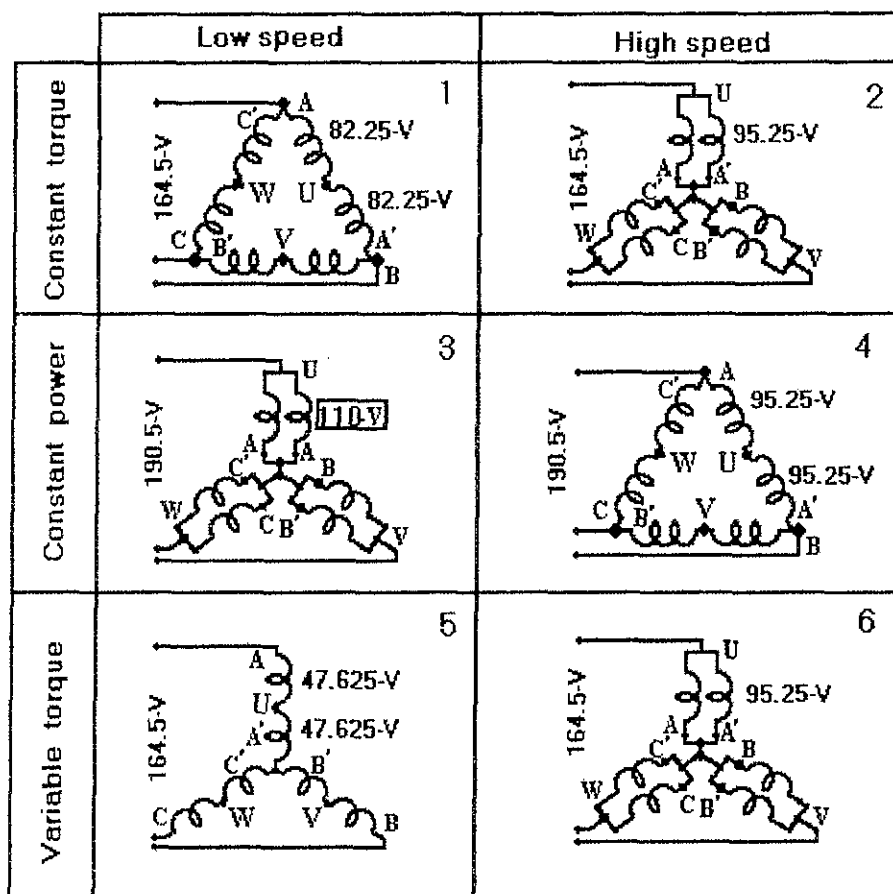

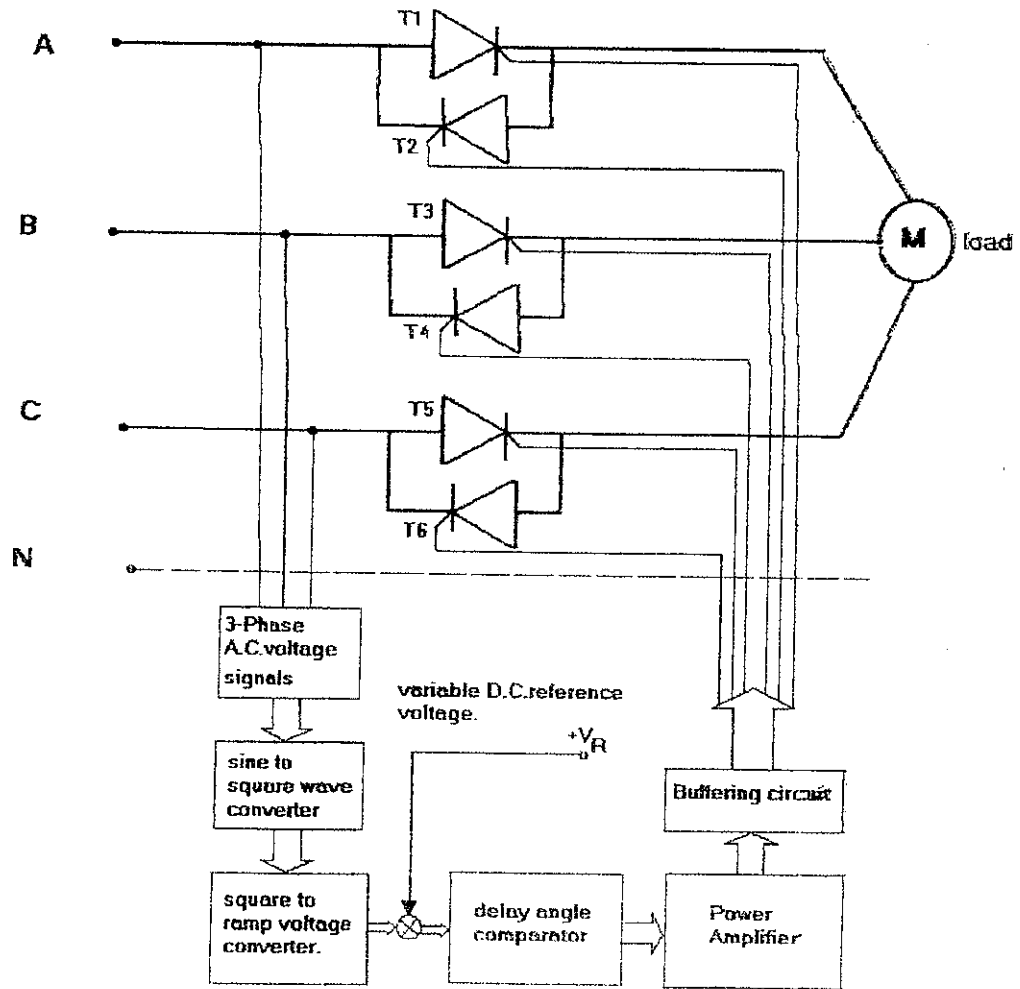

Fig. (1). Complete System Block Diagram.

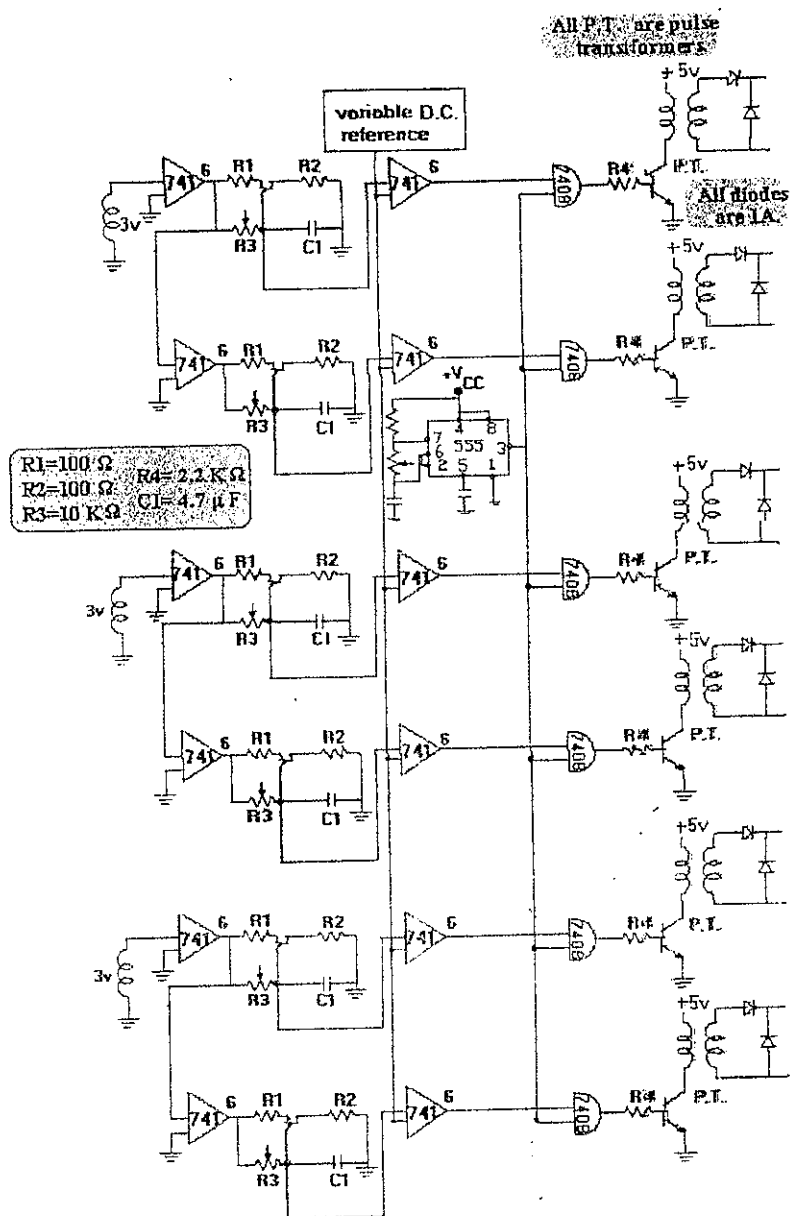

Fig. (2). Circuit diagram of the full wave voltage controller.

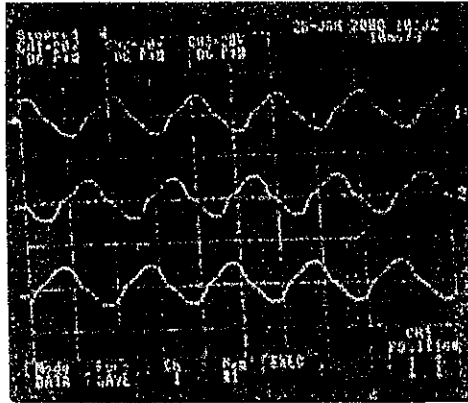

Fig. (3). Input 3 v a.c. signals of phases A,B &C.

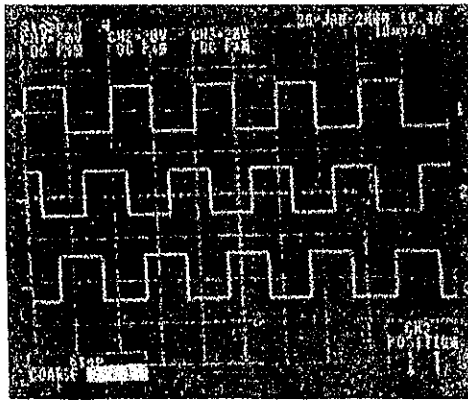

Fig. (4). The corresponding output square waves of phases A,B&C.

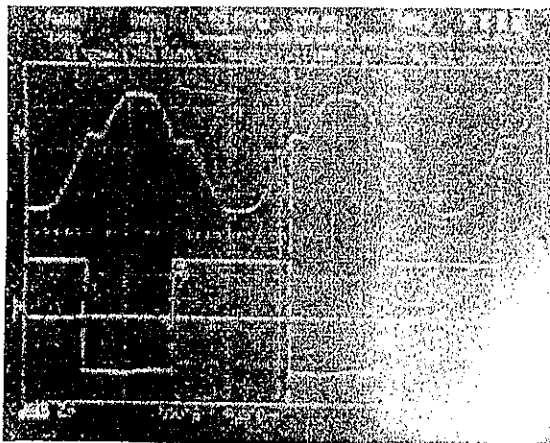

Fig. (5)
 a) Input 3-volt AC signals of phase A
 b) Corresponding square wave.-

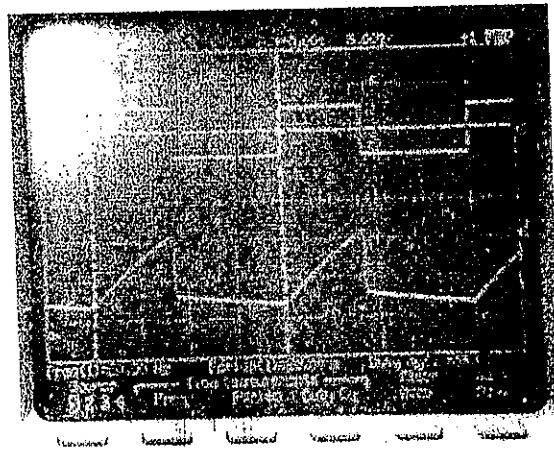

Fig. (6)

- a) Input square wave to UJT circuit
- b) Output ramp signal.

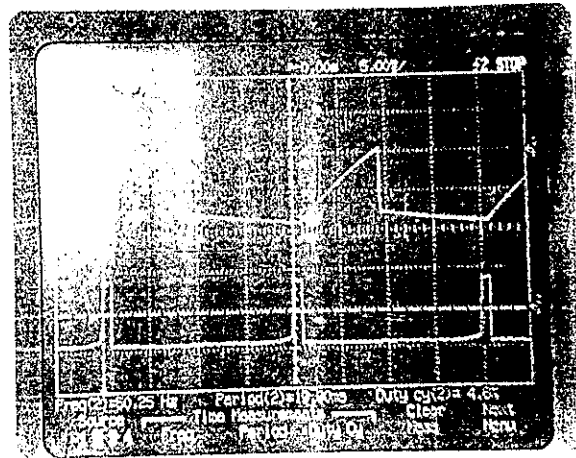

Fig. (7)

- a) Saw tooth input to the comparator.
- b) Firing signal at $\alpha = 0$.

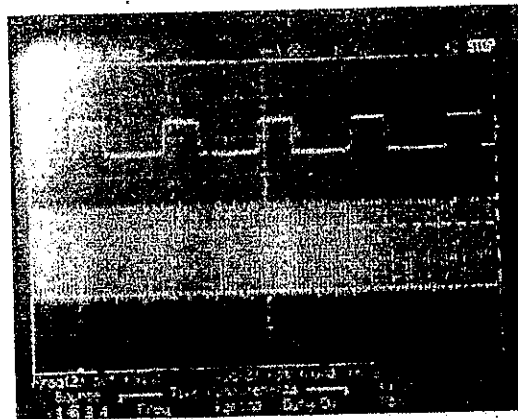

Fig. (8)

- a) Firing signal at $\alpha = 30$
- b) High frequency modulating signal.

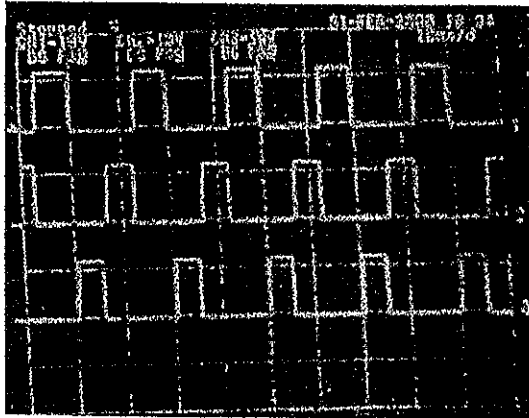

Fig. (9)
Firing signal at $\alpha=30$ for phases A,B&c

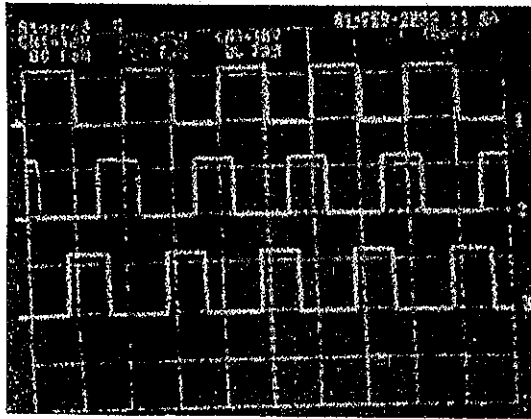

Fig. (10)
Firing signal at $\alpha=90$ for phases A,B&C.

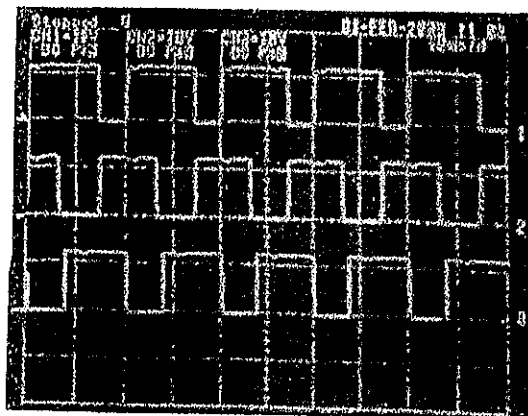

Fig. (11)
Firing signal at $\alpha=110$ for phases A , B & C

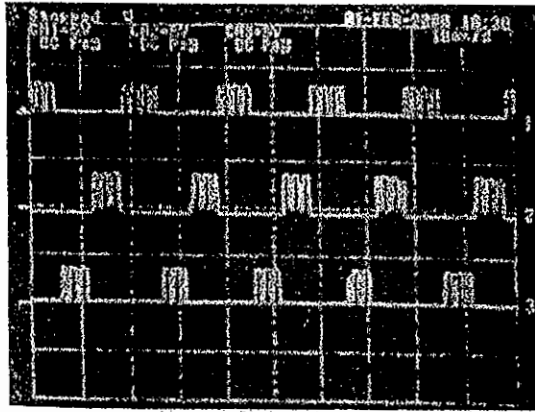

Fig. (12)

Firing signal after modulation for phases A,B & C

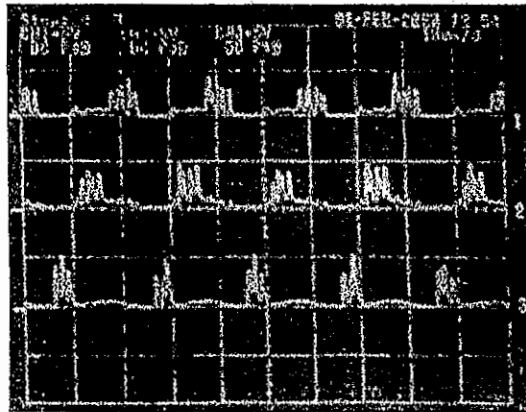

Fig. (13)

The thyristor gating pulses of phases A , B & C

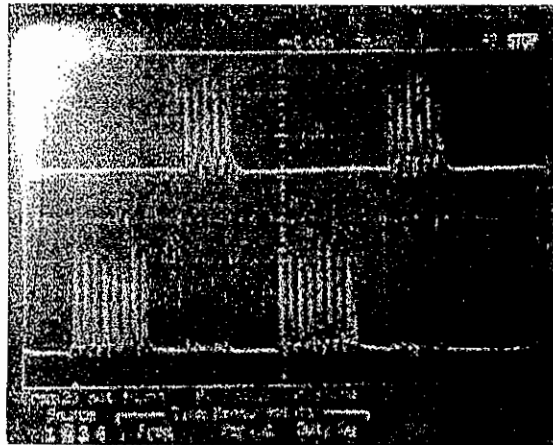
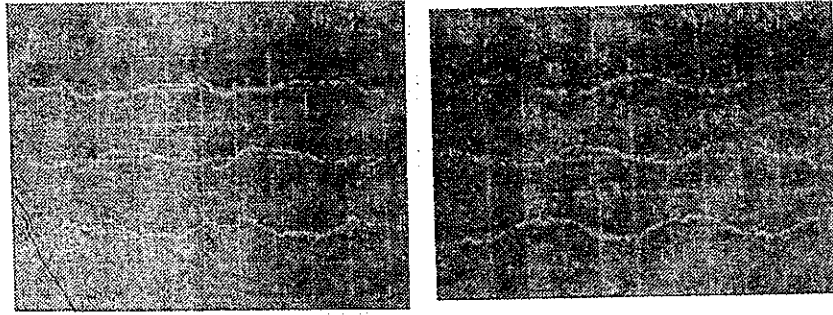

Fig. (14)

The thyristor gating pulses for a complete cycle of one phase.



(a)

(b)

Fig. (15).(a & b)
Voltage waveform of phases A , B & C at two
different angles.

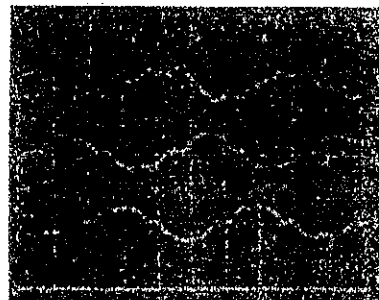
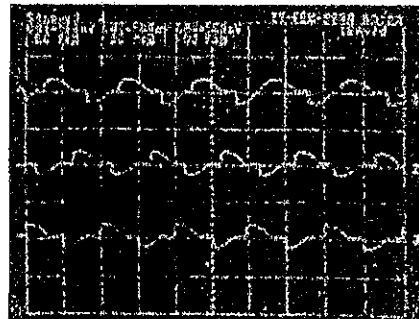
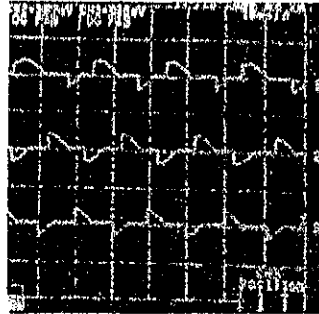

Fig. (16)
Waveforms of the load current at different firing
angles of phases A,B & C.

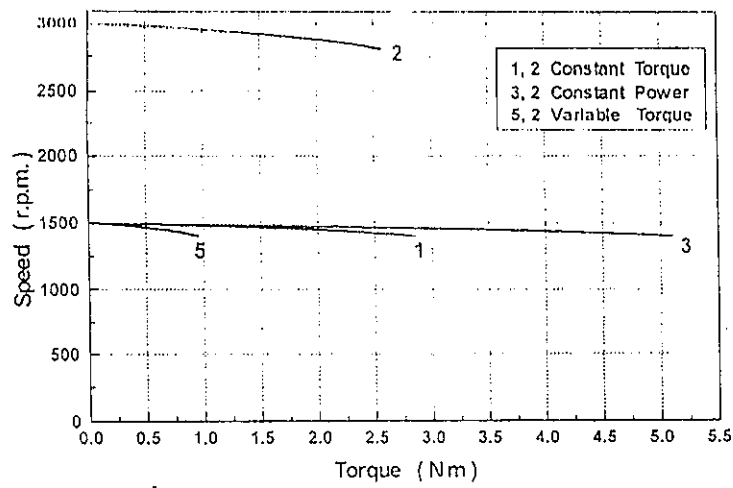

Fig.(17) Speed versus torque at different operations.

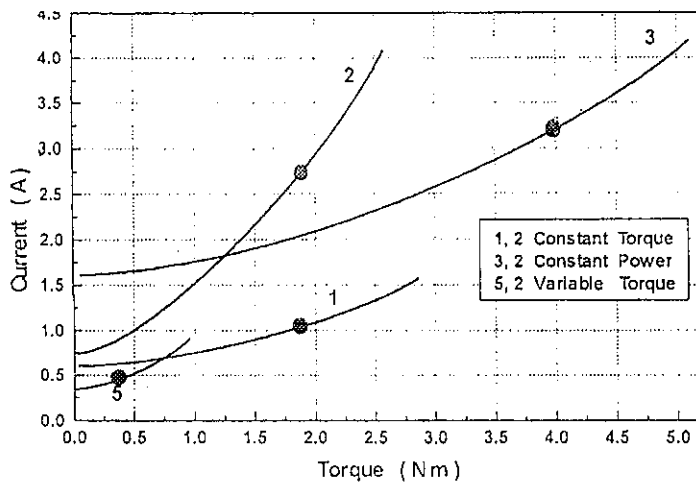

Fig.(18) Current versus torque at different operations.

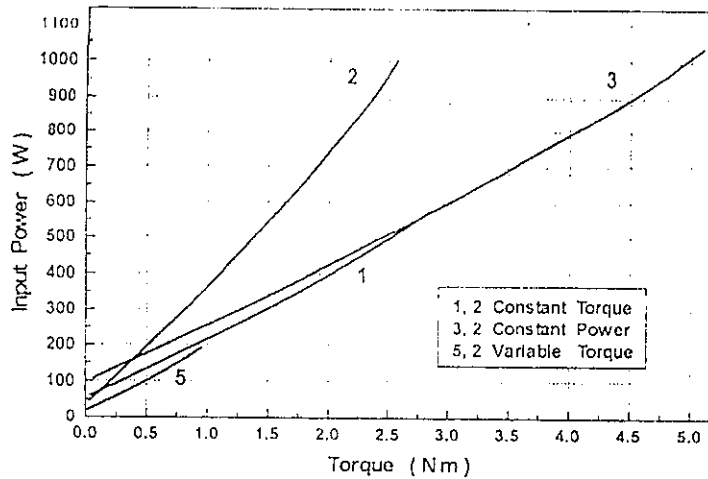

Fig.(19) Input power versus torque at different operations.

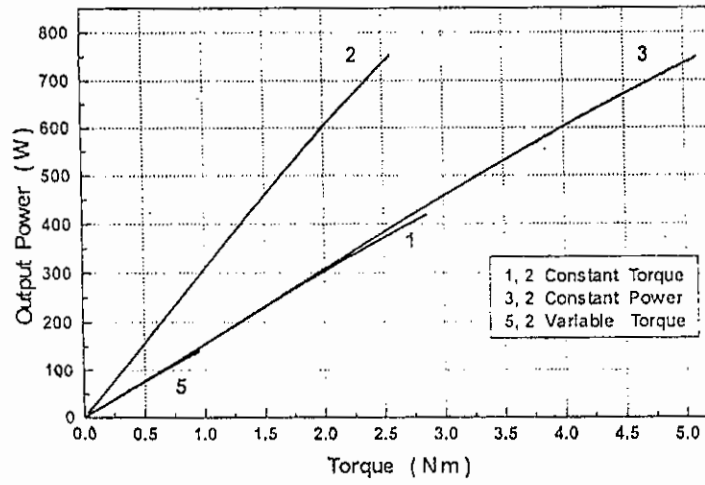

Fig.(20).Output power versus torque at different operations.

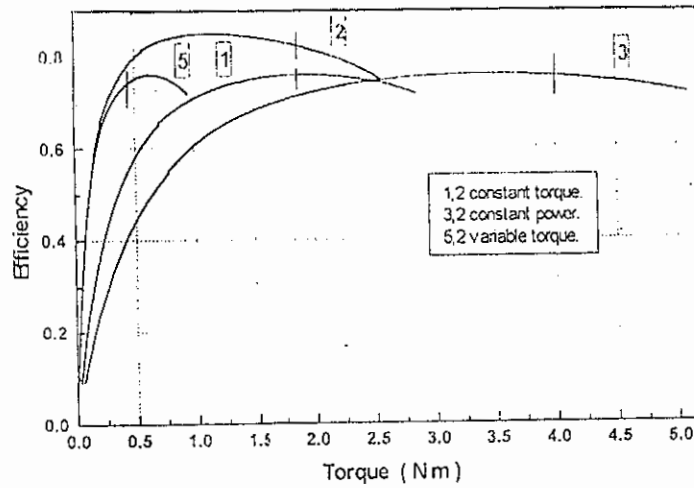

Fig. (21).Efficiency versus torque at different operations.

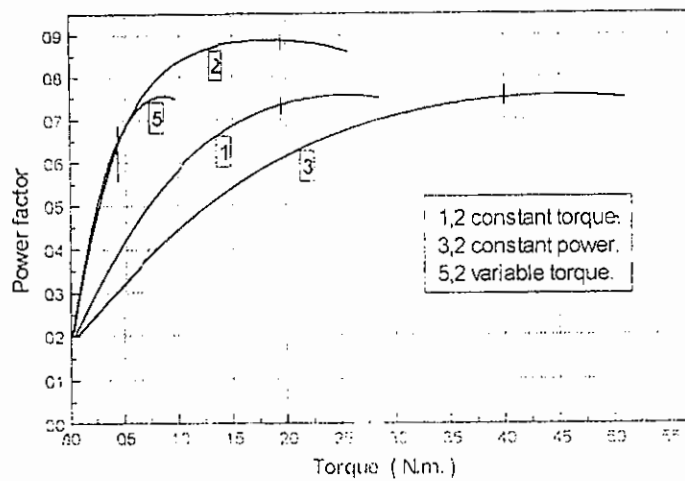

Fig.(22).Power factor versus torque at different operations

محركات الجهد ثلاثية الأوجه المغذية للمحركات التأثيرية التي تعمل بطريقة تعديل قيمة القطب .

أ.د / فتحى السيد عبدالقادر د/ أحمد السيد أبو مباركة م / وفاء شفيق أبو الفضل
قسم الهندسة الكهربائية كلية الهندسة بشبين الكوم جامعة المنوفية ج . م . ع .

مخلص البحث

المحركات التأثيرية التي تعمل بطريق تعديل قيمة القطب والتي يمكن الحصول منها على سرعتين أو أكثر لها ثلاث طرق للتشغيل تبعاً لنوع الحمل وهى ثبوت العزم وثبوت القدرة والعزم المتغير وهذا النوع من المحركات مصمم لإداء طريقة تشغيل واحدة حيث أنه لا يوجد غير منبع واحد بجهد ثابت فلو تم استخدام المحرك لأداء أكثر من عملية تشغيل فلا بد من تغيير الجهد المسلط عليه . أيضاً إذا تم تغيير الحمل فلا بد من تغيير الجهد لتحسين كفاءة المحرك . ومن هنا كان لابد من تصميم دائرة الكترونية لتغيير الجهد ليناسب الاحتياجات المختلفة للحمل .
وتم استخدام هذه الدائرة لتغيير جهد المحرك عند ادائه لعمليات التشغيل الثلاث وأجريت التجارب العملية على هذا المحرك .