

DEVELOPMENT A DEVICE FOR MEASURING ELECTROSTATIC CHARGE OF AIRBORNE PARTICLES IN LIVESTOCK HOUSING

Almuhanna, E. A.

Dept. Agric. Systems Engineering, King Faisal Univ., P.O. Box 3340, Hofuf, 31982, Saudi Arabia.

ABSTRACT

A device for measuring the net charge-to-mass ratio of airborne particles was developed to measure different levels of charges. The device involves collecting particles on a filter and measuring the electrostatic charge induced on the filter with an electrometer. The reliability of the device was tested by using electrostatic charges of known magnitude and polarity. The ability of device to measure different levels of charges was also tested using different types of airborne particles, including corn starch, sodium bicarbonate, positively-charged water spray, negatively-charged water spray, and uncharged water spray. Furthermore, the device was used to measure the charge of airborne dust in livestock and poultry housing the mean net charge-to-mass ratio was +0.68 mC/kg with standard deviation of 0.31 and -1.17 mC/kg with standard deviation of 0.81, respectively. The obtained results showed a good reproducibility.

Keywords: Electrostatic charge; Faraday cup; Sampler; Airborne particles.

INTRODUCTION

Electrostatic charging of particles is an important phenomenon that involves various applications, including electro-photography, dry powder coating, electrostatic precipitation, separation of powder, and powder flow measurement (Matsusaka and Masuda, 2003). In some cases, electrostatic charge is considered as a nuisance (Adhiwidjaja *et al.*, 1999), can cause dust explosion hazards and errors during aerosol sampling (Jones and King, 1991). In other cases, electrostatic charge can be beneficial as in the control of dust by the use of electrically charged filters or electrostatic precipitators. Similarly, charge effects on pulmonary deposition may make it useful in medication or a complication so far as hazardous dust is concerned (Brown, 1997).

Many factors can influence electrostatic charging and measurement of electrostatic charge of particles: quantity, physical characteristics, chemical composition, and moisture conditions of the material (ASTM D470, 1997). Most industrial pollutants and naturally occurring dust particles acquire electrostatic charges as they are dispersed into the air; the polarity and magnitude of the charges on these particles depend upon their size and origin (e.g., coal, soil, and mineral).

The behavior of airborne particles is governed primarily by their size and shape. It is also greatly affected by their electrostatic charge. Brown (1997) indicated that simultaneous measurement of size and charge is necessary if the properties of particles are to be understood and their behavior controlled. In controlling indoor air quality in air spaces (e.g., industrial workplaces, livestock housing, etc.), knowledge of electrostatic

charge of airborne particles is essential in designing effective particle control devices.

Several methods have been developed to measure the electrostatic charge of airborne particles; however, the majority of these is sophisticated, expensive, and designed primarily for laboratory or stationary use. The Faraday cup is a popular, versatile, and often a key device used for measuring electrostatic charge. A typical Faraday cup is a cylindrical, shielded container into which the charged material is slowly placed, and the charge induced on the inner electrode of the cup is determined by an electrometer (Kucеровsky and Kucеровsky, 2003).

This study was conducted to develop and test a portable device for measuring the amount of electrostatic charge carried by airborne particles in livestock and poultry housing, in order to assess the level of particles in the microclimate of these housing.

Charge Measuring Device (CMD)

The charge measuring device (CMD) was developed in accordance with ASTM Standard (ASTM D470, 1997) and based on the designs by John (1980) and Hinds and Kennedy (2000) as shown in Fig. (1). The device consists of two conducting enclosures, one enclosed and insulated from the other as revealed in Fig. (2). Inner enclosure has two small openings, one for air inlet and the other for air outlet; the openings were kept small to reduce leakage of external field into the cup. It was electrically connected to the electrometer input which has a particle collection filter with a back-up metal screen. It was insulated from the outer enclosure by a rigid, high resistance insulator (Poly-tetra-fluoroethylene or PTFE). The outer enclosure was connected to a grounded base and served as a shield for the inner enclosure from the external fields that could affect measurement. Field tests were conducted at the King Faisal University Research Station (Hofuf, Saudi Arabia).

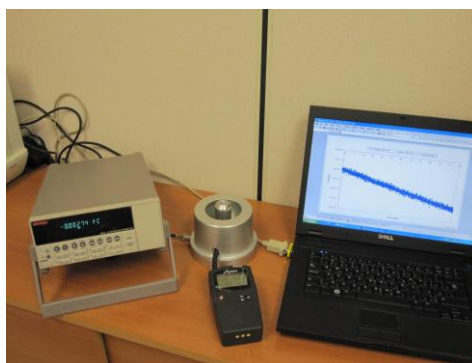

Fig.(1): Components of the Charge Measuring Device (CMD)

The CMD is connected to a low-volume sampling pump that draws air and particles into the device and collects the particles onto a filter (type AE, SKC, Eighty Four, PA). The mass of collected particles on the filter was measured by weighing the filter before and after sampling in an electronic analytical microbalance (Model AWD-120D, Shimadzu Corporation, Kyoto

Japan, with a sensitivity of 0.01 mg). The device is electrically connected to an electrometer (Model 6514, Keithley Instruments, Inc., Cleveland, OH), which is controlled by a computer. The electrometer has a very high sensitivity of the order of 10^{-15} A and high input impedance. Data from the electrometer were collected and managed by ExcelINX® software (Keithley Instruments, Inc., Cleveland, OH).

The ability of the device to accurately measure static charge was evaluated using electrostatic charge of known magnitude and polarity. A calibration circuit was prepared and used to generate known charges as shown in Fig. (3). The circuit components consisted of the following parts: (1) variable DC voltage power supply (Bk Precision Triple, MaxTec Instrumental Corp., Chicago, IL) that generated three fixed voltage values (1, 2, 3 VDC); (2) three different capacitors (0.1, 0.01, 0.001 μ F); and (3) electrometer. Different charges were obtained by changing the combination of voltage and capacitor. The generated charge was directly measured by the electrometer (i.e., CMD was not connected) and then by the CMD. The response of the device was linear with coefficient of determination of 1.0 as revealed in Fig. (3). The measurement error was negligibly due to its small value, so the measured charges in the experiments (presented later) were not corrected with the least squares regression line as shown in Fig. (4).

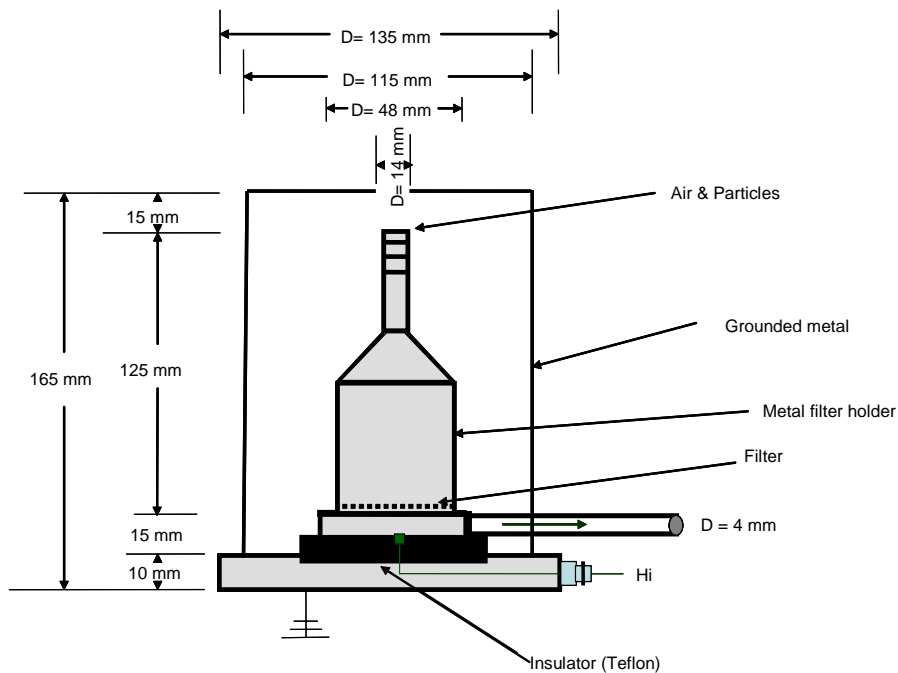

Fig. (2): Schematic diagram of the charge measuring device.

Principle of operation

If a charged object is placed into a closed metallic recipient, the internal wall of the metallic recipient will be polarized with the charge opposite to the polarity of the object. The external surface of the metallic recipient, on the other hand, will take the same charge polarity as that of the object (Ramirez. 2005).

In practical applications, the closed metallic recipient, e.g., Faraday cup was opened to allow the charged object to enter. It is important to note that the charged object does not need to be in contact with the internal walls of the cup in order to measure the charge.

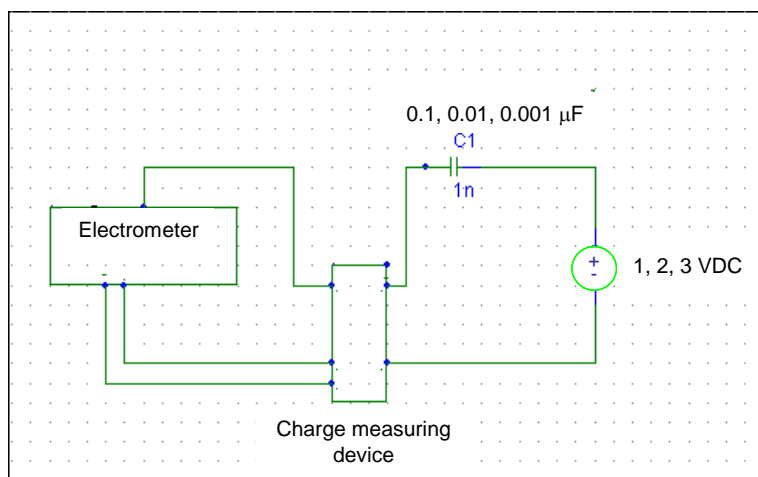

Fig. (3): Schematic diagram showing the circuit components for generating a known charge.

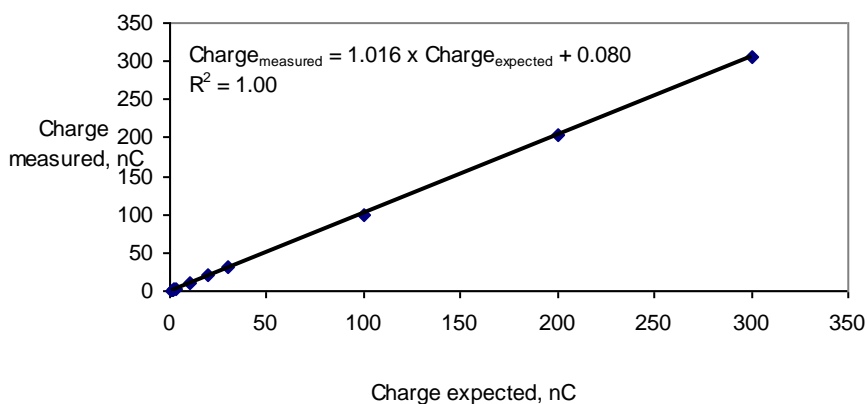

Fig. (4): Measured charge using the charge measuring device against expected charge.

Mathematically, this principle can be described as follows: let a point charge $+Q$ be placed at the center of the shell as revealed in Fig. (5) The point charge has a radial electric field, E_a . The total electric field E in the conducting wall should be zero, which requires an induced field E_i inside the wall such as:

$$\mathbf{E}_a + \mathbf{E}_i = \mathbf{E} = \mathbf{0} \quad \text{or} \quad \mathbf{E}_i = -\mathbf{E}_a \quad (1)$$

The induced field E_i was produced by a distribution of induced negative charges on the inner shell wall and induced positive charges on the outer shell wall. The charge $+Q$ at the center of the shell induces an equal but negative charge $(-Q)$ on the inner surface of the shell, and this in turn results in an equal positive charge $(+Q)$ distributed over the outer surface of the shell.

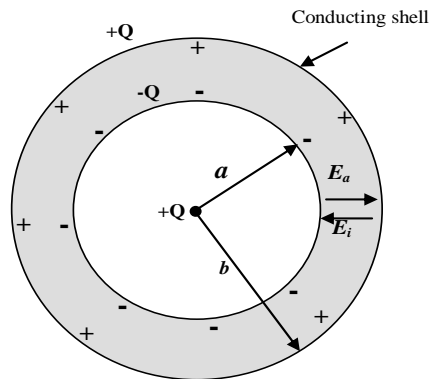

Fig. (5): Conducting shell of wall thickness $(b - a)$ with point charge $+Q$ at center.

Considering the CMD, the charge of particles that are collected on the filter and that of the particles that are traveling from the inlet to the filter will be transferred to the outer surface of the inner enclosure (filter holder) as shown in Fig. (6). In this case the net charge will continuously be increased as the particles accumulate on the filter. After the charge was transferred to the outer surface of the inner enclosure, it can be measured by connecting the CMD to a charge measuring device (electrometer).

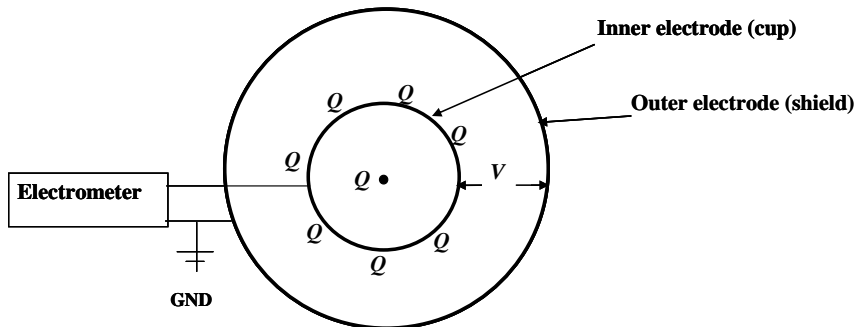

Fig.(6): Setup of charge measurement using the charge measurement device.

Experimental tests

Description of the measurements

The ability of the CMD to measure different levels of charge was tested under both controlled laboratory conditions and field conditions. Three sets of experiments were conducted: (1) aerosolized solid particles in an enclosed experimental chamber; (2) water spray in the same enclosed experimental chamber; (3) airborne particles in livestock housing; and (4) airborne particles in poultry housing.

In the first set of experiments, two types of powders were considered: corn starch and sodium bicarbonate (NaHCO_3). Experiments were conducted in an enclosed experimental chamber having a gross dimensions of 3.6 m long, 2.4 m wide, and 2.4 m high as demonstrated in Fig. (7). The chamber was maintained at room air temperature of 25°C and air relative humidity of 40% (Almuhanna *et al.*, 2008). It was located inside another large insulated chamber; both chambers were located in an environmentally-controlled laboratory. Experiments involved the following general procedures:

The experimental chamber was prepared by cleaning the surfaces and running its air filtration system. The ventilation and air filtration systems were not operated during the experiment, so that air exchange in the room was primarily through natural infiltration/exfiltration.

- (1) A pre-conditioned particle collection filter was weighed and installed onto the CMD. The CMD was set up near the center of the chamber and then operated for about 20s prior to aerosolize of particles in order to measure the background charge. The sampling pump was not operated during this 20s period.
- (2) Particles were aerosolized into the chamber using a pressurized canister with aluminum nozzle at 80 psig (Almuhanna *et al.*, 2008 ; Yadav *et al.*, 2008). A nominal mass of 20 g was used; the actual mass deployed ranged from 7.4 to 12.5 g for corn starch and from 2.7 to 8.3 g for NaHCO_3 . Aerosolize process took about 2 s. To further disperse the particles inside the chamber, two circulation fans inside the chamber were operated for about 60 s.
- (3) The CMD, including the pump, was operated 60 s to collect particles onto the filter and also to measure the charge induced on the filter.
- (4) The particle collection filter was weighed after the measurement to obtain the mass of collected particles.

The second set of experiments considered uncharged and charged (negatively charged and positively charged) water sprays. The negatively charged water spray was generated using a commercially available electrostatic spraying system (Electrostatic Spraying Systems, Inc., Watkinsville, GA), which uses induction charging. To generate the positively charged water spray, the spraying system was modified using a different charging system. To generate the uncharged water spray, the same spraying system, but with the charging system not operating, was used. For all cases, the spraying system was operated for 4 min at a liquid flow rate of about 120 mL/min (water tank pressure of 15 psig) and droplet size of about 21 μm . The CMD was operated following the same procedures for the solid particles.

In the third set of experiments, the device was used to measure the net charge-to-mass ratio of airborne particles in mechanically-ventilated livestock housing as shown in Fig. (8). During sampling, the stall barn was occupied by 160 caws. The average air temperature and air relative humidity inside the stall barn were 24.5°C and 53.5%, respectively.

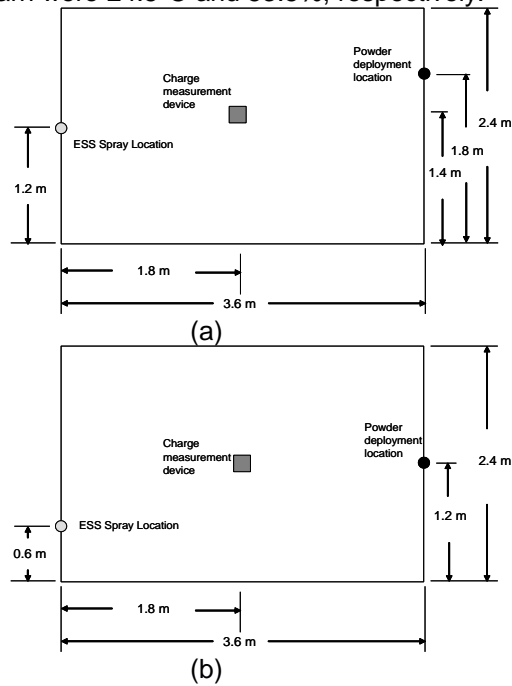

Fig. (7): Schematic diagram of the experimental chamber showing the locations of powder deployment, water spray (ESS), and charge measuring device: (a) elevation and (b) plan view.

In the fourth set of experiments, the device was used to measure the net charge-to-mass ratio of airborne particles in a naturally-ventilated poultry housing as revealed in Fig. (9). During sampling, the poultry housing was occupied by 780 birds, floor housing management. The average air temperature and air relative humidity inside the poultry housing were 25.1 °C and 28.9%, respectively.

The developed device was also used to measure the charge of the air for the air exiting an electro-statically assisted particulate wet scrubber (EPWS), (Almuhanna *et al.*, 2009).

For the three sets of experiments, the net charge-to-mass ratio (mC/kg) of particles was calculated using the following equation:

$$q_N = \frac{q - q_b}{m_p} \quad (4)$$

Where, q_N is the net charge-to-mass ratio, q is the measured charge, q_b is the device background charge, and m_p is the mass of particles collected on the filter.

Air temperature and air relative humidity were measured using a HOBO® U12 Logger (Onset Computer, Bourne, MA) with a manufacturer stated accuracy of $\pm 0.35^\circ\text{C}$; ambient temperature and air relative humidity were recorded during the experimental period and listed in Table (1).

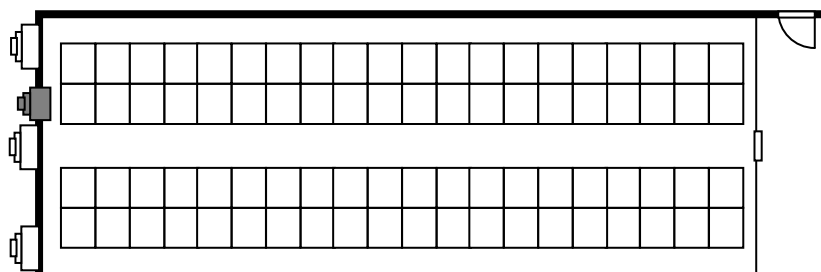

Fig. (8): Schematic diagram of the stall barn showing the distribution of the 80 caws inside the building (plan view).

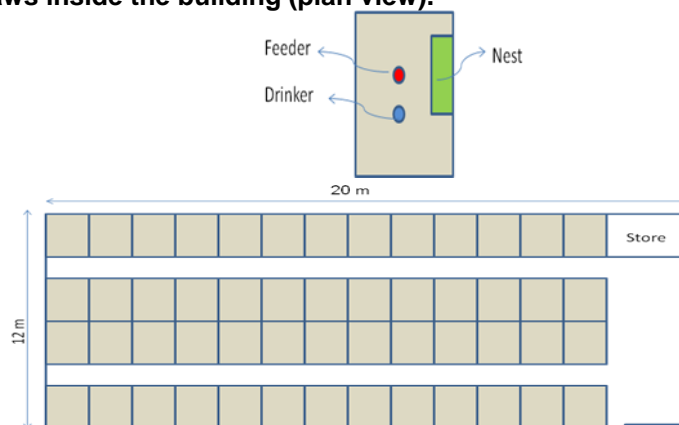

Fig. (9): Schematic diagram of the poultry housing showing the distribution of the 52 cages inside the housing (plan view).

Table (1): Average of air temperature, air relative humidity, and airborne dust mass concentration inside the test housing during the experimental period

Parameter	Test chamber		Poultry building		Livestock building	
	Mean	SD	Mean	SD	Mean	SD
Air temperature ($^\circ\text{C}$)	25	0.79	25.1	1.2	24.5	0.57
Relative humidity (%)	40	1.84	28.9	4.91	53.5	6.32
Airborne total dust mass concentration (mg/m^3)	203.2	60.91	5.44	1.47	0.89	0.46

Real-time for the total suspended particles mass concentration (TSP) was measured by the EPAM-5000 real-time sampler, manufactured by Environmental Devices Corporation, 4 Wilder Drive Bldg. 15, Plaistow, NH 03865-2856, USA. The TSP mass concentration was also measured by gravitational filter samplers (37–mm diameter filter inside a plastic filter holder) (SKC Inc., Eighty Four, PA 15330, USA) which were used as a reference method.

Measured charges

Fig. (10) shows a typical plot of the measured charge. Before the sampling pump was turned on, q_b (i.e., background charge) was firstly measured for about 20 s. When the sampling pump was turned on, q started to increase due to the accumulation of particles on the collection filter. When the pump was turned off, q stabilized, and at this point the measured charge was used to calculate q_N of the collected particles.

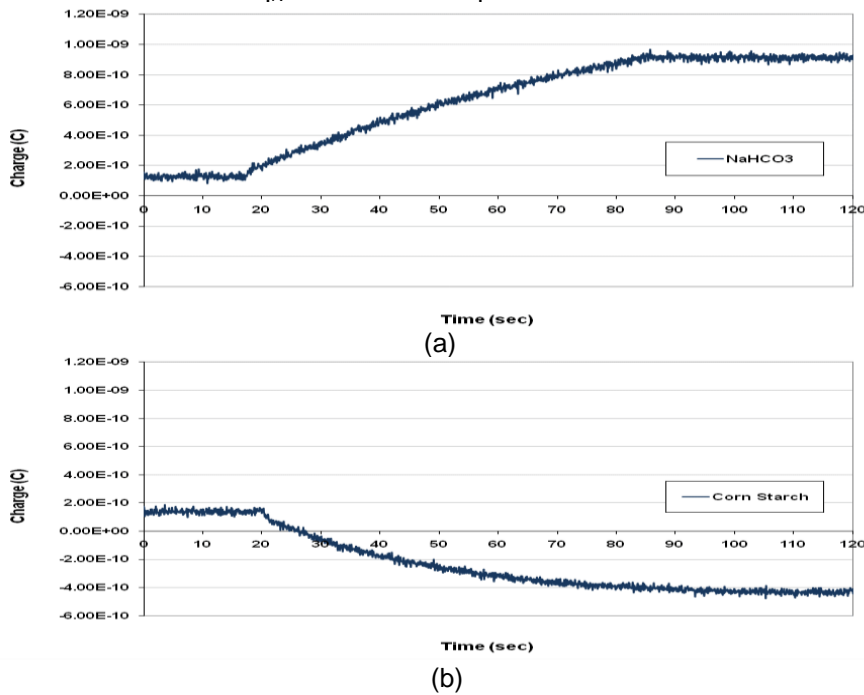

Fig. (10): Electrostatic charges of (a) NaHCO₃ and (b) corn starch as measured by the charge measuring device.

Table (2) summarizes the mean values of q_N for the aerosolized corn starch and NaHCO₃. Corn starch had a slightly negative q_N ; NaHCO₃, on the other hand, had a slightly positive q_N . The source of charge of the dispersed particles is likely due to triboelectrification (i.e., the process of charging two dissimilar bodies by contact and/or rubbing), caused by the contact between the dispersed particles with the canister aluminum nozzle, and also inter-particle contacts. Table (2) also shows the mean values of q_N for the water droplets. The “uncharged” water spray had a slightly negative q_N . With

induction charging, large values of q_N were achieved (i.e., -6.5 mC/kg for the negatively charged water spray and +7.2 mC/kg for the positively charged water spray). Inside the livestock housing, the mean q_N of airborne particles was +0.68 with standard deviation (s.d) of 0.31 mC/kg. The measured q_N value of airborne particles in the livestock housing was higher than those for the aerosolized corn starch and NaHCO_3 , possibly due to the nature of the particles in addition to the environmental conditions inside the livestock housing. Test results showed good reproducibility as indicated by the relatively small values of standard deviation.

Table (2): Mean net charge-to-mass ratios of particles, as measured with the charge measuring device.

Material	Net charge-to-mass ratio (mC/kg)	
	Mean	Standard Deviation
Laboratory experiments		
Corn starch (aerosolized)	- 0.11	0.07
Sodium bicarbonate (aerosolized)	+ 0.20	0.001
Uncharged water spray	- 0.30	0.12
Negatively charged water spray	- 6.5	0.9
Positively charged water spray	+ 7.2	1.6
Field experiments		
Livestock building (airborne dust)	+ 0.68	0.31
Poultry building (airborne dust)	- 1.17	0.81

Furthermore, Inside the poultry housing, the mean q_N of airborne particles was +0.68 (s.d.=0.31) mC/kg. The measured q_N value of airborne particles in the poultry housing was higher than those for the livestock housing possibly due to the nature of the particles in addition to the environmental conditions and high concentration of airborne particles inside the poultry housing.

Summary and Conclusions

The main objective of the present study was to develop a portable device for measuring the net charge-to-mass ratio of airborne particles. The developed device involved collecting particles on a filter and measuring the electrostatic charge induced on the filter with an electrometer. The ability of the developed device to measure different levels of charges was also tested using different types of airborne particles with different amounts of charges. The obtained results showed a good reproducibility of the device.

Acknowledgements

The author acknowledges the financial support by the deanship of Scientific Research, King Faisal University, grant No: 10121.

REFERENCES

Adhiwidjaja, I. S. ; M. S. Yahe ; and H. Masuda (1999) "Simultaneous phenomenon of particle deposition and re-entrainment in charged aerosol flow-effects of particle charge and external electric field on deposition layer". *Adv. Powder Tech.*, 11: 221-233.

- Almuhanna E. A. ; R. G. Maghirang ; J. P. Murphy ; L. E. Erickson (2009) "Laboratory Scale Electrostatically Assisted Wet Scrubber For Controlling Dust In Livestock Housing". Applied Engineering in Agriculture, 25(5):745-750.
- Almuhanna, E. A. ; R. G. Maghirang ; J. P. Murphy ; and L. Erickson (2008). "Effectiveness of electrostatically-charged water spray in reducing dust concentration in enclosed spaces". Transactions of the ASABE 51(1):279-286.
- ASTM (2004) "D4470-97 Standard test methods for static electrification"
- Brown, R. C. (1997) "Tutorial review: Simultaneous measurement of particle size and particle charge" . J. Aerosol Sci., 28:1373-1391.
- Hinds, W. C. ; and N. J. Kennedy (2000) "An ion generator for neutralizing concentrated aerosols" . Aerosol Sci. Tech. 32:214-220.
- Jones, T. B. ; and J. L. King (1991) "Powder handling and electrostatics-understanding and preventing hazards" London: Lewis.
- Kucerovsky, D. ; and Z. Kucerovsky (2003) "Analysis of the dynamic faraday cup" J. Phys. D: Appl. Phys. 36:2407-2416.
- Matsusaka, S. ; and H. Masuda (2003) "Electrostatics of particles" Adv. Powder Tech., 14: 143-166.
- Ulaby, F. T. (2004) "Fundamentals of Applied Electromagnetics". New Jersey: Pearson Prentice Hall.
- Yadav, R. ; R. G. Maghirang, L. E. Erickson ; B. Kakumanu ; and S.G. Castro (2008) "Laboratory evaluation of the effectiveness of nanostructured and conventional particles in clearing smoke in confined spaces" .Fire Safety J. 43(1):36-41.

تطوير جهاز لقياس نسبة صافي الشحنة الالكتروستاتيكية الى الكتلة للجسيمات الصلبة المعلقة بالهواء فى إسطبلات الماشية

عماد أحمد المهنا

قسم هندسة النظم الزراعية - جامعة الملك فيصل - الهفوف - المملكة العربية السعودية

تم تطوير جهاز لقياس نسبة صافي الشحنة الالكتروستاتيكية الى الكتلة للجسيمات الصلبة المعلقة بالهواء. الجهاز يتضمن جمع الجسيمات الدقيقة فى مرشح خاص وقياس الشحنة الكهربائية المصاحبة للكمية المجمعة. تم اختبار موثوقية الجهاز باستخدام شحنات كهربائية معلومة القوة والاستقطاب. كما تم أيضاً اختبار قدرة الجهاز لقياس مستويات مختلفة من الشحنات باستخدام أنواع مختلفة من الجسيمات الدقيقة المحمولة بالهواء، شمل ذلك مسحوق الذرة والنشاء، وبيكربونات الصوديوم، قطيرات الماء المرشوشة والمشحونة بشحنات موجبة وأخرى سالبة. إضافة الى ذلك، تم استخدام الجهاز لقياس الشحنات الكهربائية الالكتروستاتيكية المرافقة للغبار في الهواء الداخلى لإسطبلات الماشية ومساكن الدواجن حيث كان متوسط صافي نسبة الشحنة الى الكتلة $+0.68$ (s.d.=0.31) ، و -1.17 (s.d.=0.81) ميلي كولومب/كجم على التوالي. كما أوضحت النتائج المتحصل عليها قدرة الجهاز لاعطاء نتائج ذات تناسق متكرر مع دقة قياس عالية.

1

2

قام بتحكيم البحث

كلية الزراعة - جامعة المنصورة

كلية الزراعة - جامعة الزقازيق

أ.د / صلاح مصطفى عبد اللطيف

أ.د / محمود عبد الرحمن الشاذلى